

Hisense Quick Setup Guide

814100264

4K HDR Smart TV

Please read this manual carefully before operating your unit and retain for future reference.

Disclaimer

Disclaimer: Subscriptions or other payments may be required to access content through some applications. Some or all of the included or downloaded application services in this Hisense device may not function depending on the Internet connection, local limitations of included applications or other reasons outside of Hisense's control. HISENSE EXPRESSLY DISCLAIMS RESPONSIBILITY FOR ANY APPLICATION SERVICE FROM FUNCTIONING AT ANY TIME, FOR CONTENT IN ANY APPLICATION SERVICE, FOR DISRUPTIONS OF SERVICE, LOCAL OR REGIONAL LIMITATIONS, WARRANTIES OF TITLE, NO INFRINGEMENT, AND FOR IMPLIED WARRANTIES OF MERCHANTABILITY OR FITNESS FOR A PARTICULAR PURPOSE. By purchasing this device, you accept such Disclaimer without any claim on Hisense at any time.

This Quick Setup Guide supports the following models:

43QD65NF / 50QD65NF / 55QD65NF / 65QD65NF / 75QD65NF

What's in the box

Your Hisense TV comes with the following items:

- TV
- Power cord
- Remote control
- 2 base stands
- 4 screws

The accessories may be different from the list above due to different models, countries/regions, please contact a service center.

Accessory type and quantity may vary depending on the model.

Disclaimer: This Quick Setup Guide is intended as a general guideline to help you set up your TV. Images throughout this document are for illustrative purposes only and may differ from the actual product.

Getting started

Step 1. Attach stand or mount

Before you start using your TV, attach your TV stand or mount it on the wall.

CAUTION:

- Disconnect the AC power cord before installing a stand or a wall mount bracket.
- The display on your TV is fragile. Make sure the TV screen is not scratched or damaged by hard objects or from pressure.
- After the installation is complete, make sure the TV is steady on a table or firmly attached to a wall mount, before removing all protective film, if any.

Attach the TV stand

To attach the TV stand legs to your TV:

1. Carefully place your TV face down on a clean, soft, flat surface.
2. Insert the TV base stands into the bottom slots on your TV.
3. Use the screws provided to secure each stand tightly.

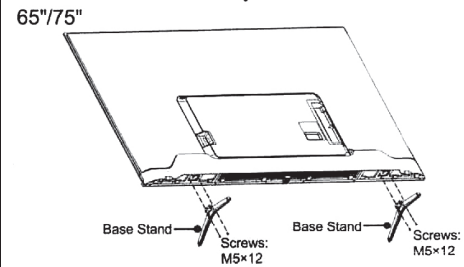
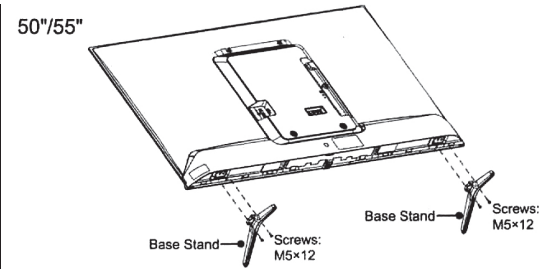
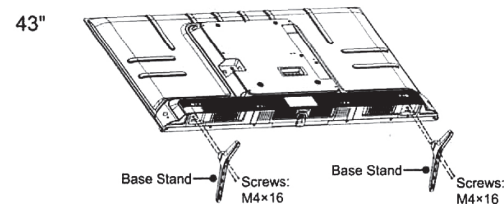

Attach the wall mount bracket (not included)

43"/55"

Before you begin the third-party manufacturer instructions, be sure to do the following things:

1. Place the TV face down on a clean, safe and cushioned surface.
2. Remove the TV stands if you have already attached them.
3. Place spacers (not included) in the corresponding bracket holes.

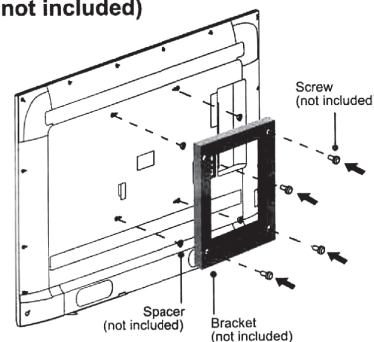

50"/55"/65"

Before you follow the third-party manufacturer instructions to attach the wall mount, be sure to do the following things:

1. Place the TV face down on a clean, safe and cushioned surface.
2. Remove the TV stands if you have already attached them.
3. Take the nuts out of the accessory bag and tighten the nuts into the holes of the back cover (See Fig. 1).
4. Place spacers (not included) between the TV and the bracket (See Fig. 2).

50"/55"

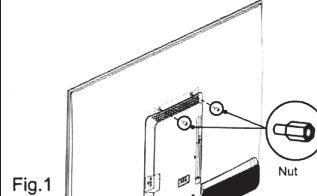

Fig.1

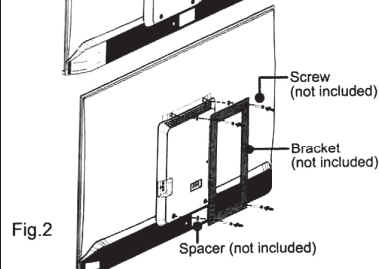

Fig.2

65"

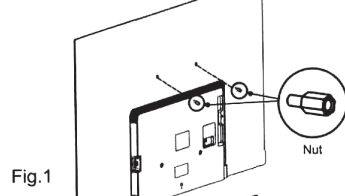

Fig.1

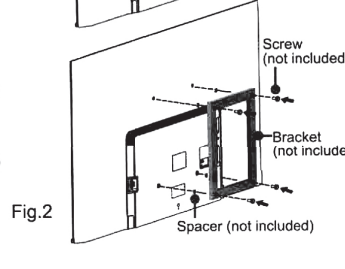

Fig.2

The images shown here are for illustrative purposes only and may be subject to change, the actual descriptions of control panel and their locations may vary depending on the model.

CAUTION:

- Follow instructions provided with the wall mount bracket. If it is not correctly mounted, the TV may fall and cause property damage or personal injury.
- When you attach the mount, be sure to use spacers (provided by the third-party manufacturer) between the TV and the bracket.
- To prevent internal damage to the TV and to ensure it is mounted securely, be sure to use fixing screws (not included) that are 8.0 - 10.0 mm(43"/50"/55"/65") or 9.5 - 11.5 mm(75") in length when measured from the attaching surface of the rear cover.

8.0 - 10.0 m (43"/50"/55"/ 65")
9.5 - 11.5 mm(75")

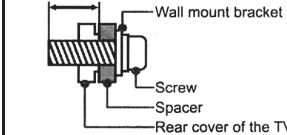

Wall mount hole pattern(mm)	200 × 300 (43") 200 × 400 (50"/55") 300 × 400 (65") 400 × 300 (75")
Wall mount screw size	M6

- We do not recommend hanging the TV on a slanted wall, and when wall mounting make sure your television remains parallel to the wall and does not lean forward.

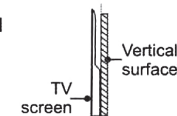

NOTE:

- If installed on a ceiling or slanted wall, or the television installed is not parallel to the wall, the television may fall and result in property damage or severe personal injury.
- If you have additional questions, please contact the wall mount manufacturer or the retailer from which you purchased the TV.
- The diameter and length of the screws differ depending on the wall mount bracket model.

Step 2. Connect devices to your TV

Check to ensure that you have connected the right cables to the right ports securely. Loose connections can affect the quality of the picture image and color.

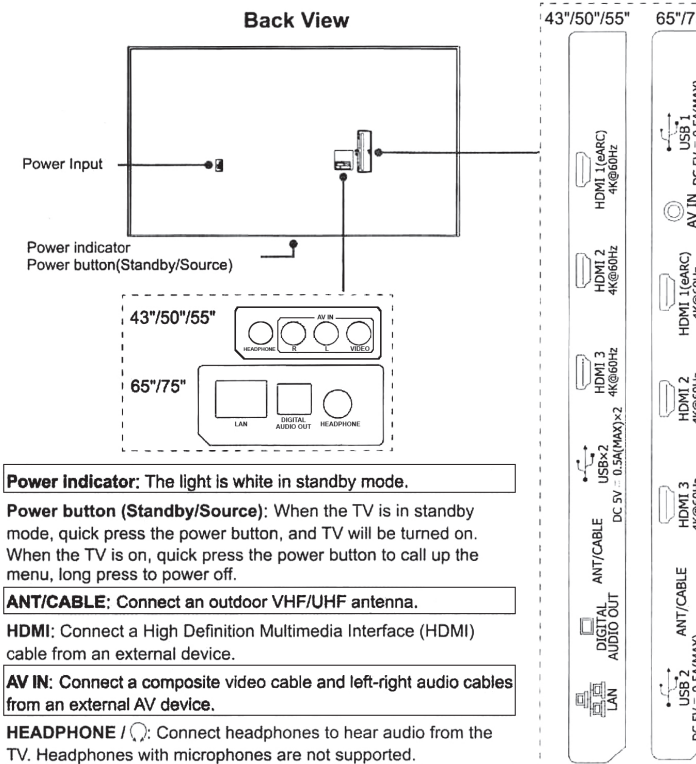

- **Power indicator:** The light is white in standby mode.
- **Power button (Standby/Source):** When the TV is in standby mode, quick press the power button, and TV will be turned on. When the TV is on, quick press the power button to call up the menu, long press to power off.
- **ANT/CABLE:** Connect an outdoor VHF/UHF antenna.
- **HDMI:** Connect a High Definition Multimedia Interface (HDMI) cable from an external device.
- **AV IN:** Connect a composite video cable and left-right audio cables from an external AV device.
- **HEADPHONE / :** Connect headphones to hear audio from the TV. Headphones with microphones are not supported.
- **USB:** Connect a USB device for browsing photos, music and movies. Hard disks with a total current consumption or impulse current consumption greater than 500mA are not supported.
- **LAN:** Connect an Ethernet cable to access a network or the Internet. The TV also has a wireless connectivity feature.
- **DIGITAL AUDIO OUT:** Connect an optical cable from an external digital audio system.

Step 3. Get to know controls

Control on the TV

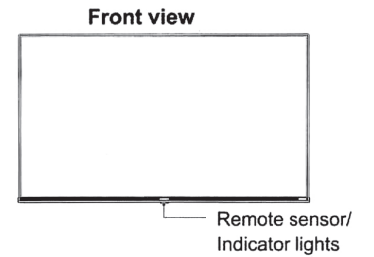

Introduction

Unlock the power of your Hisense with Fire TV built-in with the included Voice Remote with Alexa. Use your voice to watch live TV, search for titles, play music, switch inputs, control compatible smart home devices, and more. Switch inputs and go from watching your favorite TV show to the big game. You can also ask Alexa to check the weather, set timers and reminders, and more. Here are a few things that you can do with your voice on your Hisense Fire TV:

To do this on your Hisense FireTV...	Say this...
Live TV Controls For supported apps that feature live TV access, you can use Alexa to change channels. You can also use Alexa to navigate to the Channel Guide and the Live tab.	"Alexa, go to [channel / network] on [app]." "Alexa, watch [channel / network]." "Alexa, go to Channel Guide." "Alexa, go to Live."
Search for movies and TV shows Alexa can find movies and TV shows.	"Alexa, show me new [tv shows / movies]." "Alexa, find [title / genre]."
Alexa Requests See the responses on Hisense with Fire TV when you make an Alexa request	"Alexa, show me the weather." "Alexa, add x to my shopping list." "Alexa, play songs by [artist]." "Alexa, show me restaurants nearby."

Get your remote ready

The following table shows the buttons on your remote control and describes what they are for.

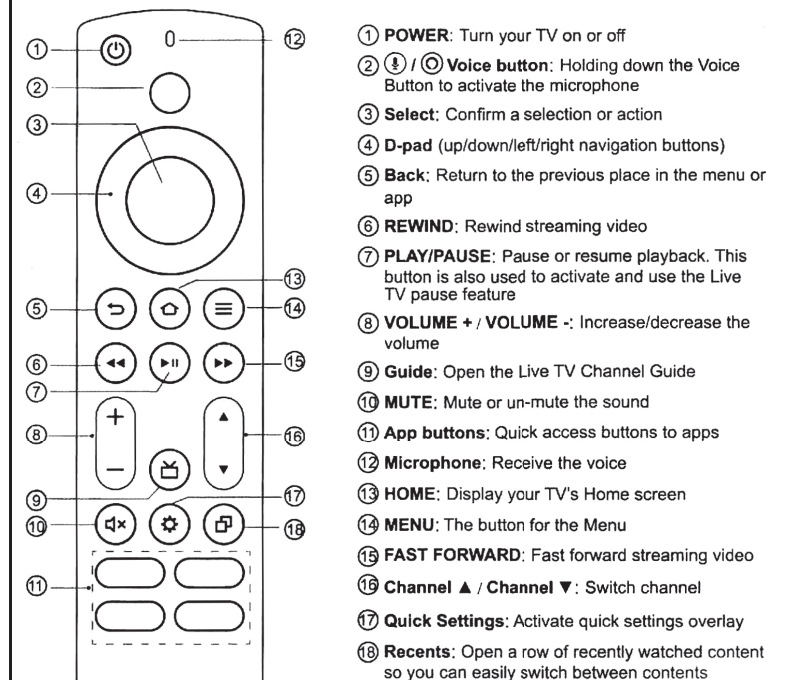

The remote control vary depend of model: The buttons on the remote control may have a different name or location than the remote control shows in this manual.

NOTE:

- The picture is only for reference. Check information according to the actual remote control.

Insert the batteries (Batteries Not Included)

Remove the battery cover and insert the two AAA batteries into your Alexa Voice Remote.

Important information about the remote and batteries

- Discard batteries in a designated disposal area. Do not throw them into a fire.
- Remove old batteries immediately to prevent them from leaking into the battery compartment.
- If you do not intend to use the remote control for a long time, then remove the batteries.
- Battery chemicals can cause a rash. If the batteries leak, clean the battery compartment with a cloth. If chemicals touch your skin then wash it immediately.
- Do not mix old and new batteries.
- Only use new 1.5v alkaline or 1.2NiMH rechargeable AAA sized batteries. Do not mix alkaline or rechargeable NiMH batteries.
- Do not continue using the remote if it gets warm or hot.

Using your cable set-top box or satellite receiver remote as a 'universal' remote

If you prefer to use your Cable Set-top Box or Satellite Receiver Remote as a 'universal' remote, Contact a service center.

Step 4. Power on the TV

Connect your power cord to the TV and plug it into a power outlet. Press power button of the TV or the power button on the remote to turn on the TV.

Your TV will display a launch screen showing the Hisense logo.

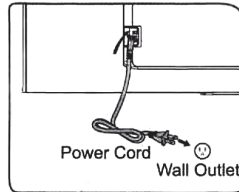

Step 5. Complete the first-time setup

The first time you turn on your TV, there is a guided setup to make it easy to connect your TV to the Internet and complete the setup of your TV.

Your TV will automatically pair with your new Alexa Voice Remote.

1. If there are issues with the remote pairing, you will be prompted to pair your remote by pressing and holding the **HOME** button. If you continue to have issues, try re-inserting or replacing your batteries.
2. Select your Wi-Fi network from the list of Wi-Fi networks displayed on the screen.

NOTE:

- If your Wi-Fi network is password protected, please have your Wi-Fi network password handy to connect your TV to the Internet. If your network is hidden, select the **Join Other Network**. If required, enter your network password using the on-screen keyboard.

Step 6. Enjoy your TV!

Now that you've completed the first-time setup, your Home screen is your starting point for using your TV. Your Hisense TV provides a variety of entertainment options, so you'll always find something new. Use your TV to watch live channels, access video on demand to watch movies, and much more.

The image shown here is for illustrative purposes only and may be subject to change.

The cables mentioned in this guide is not supplied with your unit.

PRINTED IN MEXICO Elbrd: J.E SC: 07-18-2024

OBPN: 1403479 ES-A24048F-1 **SHDML:** 65QD65NF_B



814100264

Troubleshooting

If you are having trouble with your TV, first try turning it off and on again. If this does not fix the problem, check the tips in the following table.

Issues	Possible solutions
No sound or picture	<ul style="list-style-type: none">• Check if the power cord is plugged into a powered AC outlet.• Press the Power button on the remote control to activate the unit from 'Standby' mode.• Check to see if the LED light is on or not. If it is, then the TV is receiving power.
I have connected an external source to my TV and I get no picture and/or sound.	<ul style="list-style-type: none">• Check for the correct output connection on the external source and for the correct input connection on the TV.• Make sure you have made the correct selection for the input mode for the incoming signal.
When I turn on my TV, there is a delay for a few seconds before the picture appears. Is this normal? The picture is normal but there is no sound	<ul style="list-style-type: none">• Yes, this is normal. The TV is initializing and searching for previous setting information.• Check the volume settings.• Check if 'Mute' mode is set to On.
Sound but no picture or black and white picture	<ul style="list-style-type: none">• If the picture is black and white, unplug the TV from the AC outlet and replug it after 60 seconds.• Check that the Color is set to 50 or higher.• Try different TV channels.
The sound and/or picture is distorted or appears wavy	<ul style="list-style-type: none">• An electric appliance may be affecting the TV. Turn off any appliances that are nearby and move it farther away from the TV.• Insert the power plug of the TV set into another power outlet.
The sound and picture is blurry or cuts out	<ul style="list-style-type: none">• If using an external antenna, check the direction, position and connection of the antenna.• Adjust the direction of your antenna or reset or fine tune the channel.
A horizontal or vertical stripe appears on the picture and/or the picture is shaking	<ul style="list-style-type: none">• Check if there is an appliance or electric tool nearby that is causing interference.
The plastic cabinet makes a "clicking" type of sound	<ul style="list-style-type: none">• The 'click' sound can occur when the temperature of the television changes. This change causes the television cabinet to expand or contract, which makes the sound. This is normal and the TV is OK.
The remote control does not work	<ul style="list-style-type: none">• Confirm that TV still has power and is operational.• Change the batteries in the remote control.• Check if the batteries are correctly installed.

Product Specifications

Model Name	43QD65NF	50QD65NF
Dimension (W × H × D)	Without Stand 37.9 × 22.0 × 2.9 inches (963 × 560 × 74 mm)	44.1 × 25.6 × 3.1 inches (1119 × 650 × 80 mm)
	With Stand 37.9 × 23.9 × 8.3 inches (963 × 606 × 210 mm)	44.1 × 27.6 × 10.8 inches (1119 × 700 × 274 mm)
Weight	Without Stand 15.0 lbs (6.8 kg)	19.2 lbs (8.7 kg)
	With Stand 15.2 lbs (6.9 kg)	19.4 lbs (8.8 kg)
TV Stand Width(W × D)	29.8 × 8.3 inches (758 × 210 mm)	35.2 × 10.8 inches (893 × 274 mm)
Active Screen Size (Diagonal)	42.5 inches (107.9 cm)	49.5 inches (125.7 cm)
Audio Power	7 W + 7 W	8 W + 8 W
Model Name	55QD65NF	65QD65NF
Dimension (W × H × D)	Without Stand 48.5 × 28.1 × 3.1 inches (1233 × 715 × 80 mm)	57.2 × 33.1 × 3.0 inches (1453 × 840 × 76 mm)
	With Stand 48.5 × 30.2 × 10.8 inches (1233 × 767 × 274 mm)	57.2 × 35.3 × 11.8 inches (1453 × 897 × 299 mm)
Weight	Without Stand 24.0 lbs (10.9 kg)	33.1 lbs (15.0 kg)
	With Stand 24.3 lbs (11.0 kg)	33.5 lbs (15.2 kg)
TV Stand Width(W × D)	38.3 × 10.8 inches (973 × 274 mm)	39.0 × 11.8 inches (991 × 299 mm)
Active Screen Size (Diagonal)	54.6 inches (138.7 cm)	64.5 inches (163.8 cm)
Audio Power	8 W + 8 W	10 W + 10 W
Model Name	75QD65NF	
Dimension (W × H × D)	Without Stand 66.0 × 37.8 × 3.4 inches (1676 × 960 × 87 mm)	
	With Stand 66.0 × 41.1 × 14.6 inches (1676 × 1044 × 370 mm)	
Weight	Without Stand 50.3 lbs (22.8 kg)	
	With Stand 50.9 lbs (23.1 kg)	

TV Stand Width(W × D)	51.9 × 14.6 inches (1318 × 370 mm)
Active Screen Size (Diagonal)	74.5 inches (189.3 cm)
Audio Power	12 W + 12 W
Screen Resolution	3840 × 2160
Power consumption	Please refer to the rating label.
Power Supply	Please refer to the rating label.
Connectivity	Built-in Wireless feature (2x2, dual band)
Receiving Channels	VHF: 2 - 13, UHF: 14 - 69, CATV: 1 - 125 Digital Terrestrial Broadcast (8VSB): 2 - 69 Digital cable (64/256 QAM): 1 - 135
Tuner Type	Frequency synthesized
Receiving System	Analog: NTSC Digital: ATSC/QAM
Operating Temperature	41°F - 95°F (5°C - 35°C)
Operating Humidity	20% to 80% non-condensing
Storage Temperature	5°F to 113°F (-15°C to 45°C)
Storage Humidity	10% to 70%, non-condensing

Disclaimer: All products, product specifications, and data are subject to change without notice to improve reliability, function, design or otherwise.

Certification and compliance

NOTE: The following warnings only apply to products with such certification.

This device complies with Part 15 of the FCC Rules. Operation is subject to the following two conditions: (1) This device may not cause harmful interference, and (2) This device must accept any interference received, including interference that may cause undesired operation.

Note: This equipment has been tested and found to comply with the limits for a Class B digital device, pursuant to Part 15 of the FCC Rules. These limits are designed to provide reasonable protection against harmful interference in a residential installation. This equipment generates, uses, and can radiate radio frequency energy and, if not installed and used in accordance with the instructions, may cause harmful interference to radio communications. However, there is no guarantee that interference will not occur in a particular installation. If this equipment does cause harmful interference to radio or television reception, which can be determined by turning the equipment off and on, the user is encouraged to try to correct the interference by one or more of the following measures:

- Reorient or relocate the receiving antenna.
- Increase the separation between the equipment and receiver.
- Connect the equipment into an outlet on a circuit different from that to which the receiver is connected.
- Consult the dealer or an experienced radio/TV technician for help.

The manufacturer is not responsible for any radio or TV interference caused by unauthorized modifications to this equipment. Such modifications could void the user's authority to operate the equipment.

This equipment complies with FCC radiation exposure limits set forth for an uncontrolled environment. This equipment should be installed and operated with minimum distance of [20] cm between the radiator and your body. This transmitter must not be co-located or operating in conjunction with any other antenna or transmitter.

This device contains licence-exempt transmitter(s)/receiver(s) that comply with Innovation, Science and Economic Development Canada's licence-exempt RSS(s). Operation is subject to the following two conditions:

- (1) This device may not cause interference.
- (2) This device must accept any interference, including interference that may cause undesired operation of the device.

This equipment complies with radio frequency exposure limits set forth by the Innovation, Science and Economic Development Canada for an uncontrolled environment. This equipment should be installed and operated with a minimum distance of 20 cm between the device and the user or bystanders.

This device must not be co-located or operating in conjunction with any other antenna or transmitter.



The terms HDMI, HDMI High-Definition Multimedia Interface, HDMI Trade dress and the HDMI Logos are trademarks or registered trademarks of HDMI Licensing Administrator, Inc.



Dolby, Dolby Vision, Dolby Atmos, and the double-D symbol are registered trademarks of Dolby Laboratories Licensing Corporation. Manufactured under license from Dolby Laboratories. Confidential unpublished works. Copyright © 2012–2022 Dolby Laboratories. All rights reserved.



Environmental Protection

This mark indicates that this product should not be disposed together with other domestic garbage, to avoid damage to the environment or human health due to the disposal of uncontrolled waste. Recycle it responsibly for promoting the sustainable reuse of material resources. To return your used device, please use the return systems available in your location or contact the vendor where you purchased your product they could take this product for recycling and protection of the environment.

©2024. All rights reserved.

Amazon, Fire, and all related marks are trademarks of Amazon.com, Inc. or its affiliates. This device is not manufactured by Amazon.com, Inc. or any Amazon affiliates. Certain services and features are subject to change or withdrawal at any time, may not be available in all areas and languages, or in 4K, and may require separate subscriptions.

THIS PRODUCT IS LICENSED UNDER THE AVC PATENT PORTFOLIO LICENSE FOR THE PERSONAL USE OF A CONSUMER OR OTHER USES IN WHICH IT DOES NOT RECEIVE REMUNERATION TO (i) ENCODE VIDEO IN COMPLIANCE WITH THE AVC STANDARD ("AVC VIDEO") AND/OR (ii) DECODE AVC VIDEO THAT WAS ENCODED BY A CONSUMER ENGAGED IN A PERSONAL ACTIVITY AND/OR WAS OBTAINED FROM A VIDEO PROVIDER LICENSED TO PROVIDE AVC VIDEO. NO LICENSE IS GRANTED OR SHALL BE IMPLIED FOR ANY OTHER USE. ADDITIONAL INFORMATION MAY BE OBTAINED FROM MPEG LA, L.L.C. SEE [HTTP://WWW.MPEGLA.COM](http://www.mpegla.com)

AMAZON TERMS & POLICIES

Before using Hisense with Fire TV, please read the terms located at www.amazon.com/deviceservices/support. Please also read all terms and policies for services related to Hisense with Fire TV, including but not limited to Amazon's Privacy Notice located at www.amazon.com/privacy, Amazon's Conditions of Use located at www.amazon.com/conditionsofuse, and any other terms or usage provisions available at www.amazon.com/deviceservices/support. All terms, rules, notices, policies, and provisions are, collectively, the "Agreements." By using Hisense with Fire TV, you agree to be bound by the terms of the Agreements.

REFURBISHED PRODUCT LIMITED NINETY DAYS WARRANTY

The **Refurbished Product Service Center** offers the following WARRANTY to the ORIGINAL purchaser of a product which we have refurbished.

This product that has been refurbished is warranted against any electronic or mechanical defects for a period of NINETY DAYS from the date of the original purchase by the consumer. Since this unit was sold as a refurbished item, the warranty does not apply to any cosmetic appearance items such as scratches. Should a defect occur, the **Refurbished Product Service Center** will repair or, at its option, replace defective unit/parts with new or rebuilt materials without charge for either parts or labor. Replacement unit/parts will be warranted for the remaining portion of the original warranty period.

This warranty does not cover installation or damage from accident, misuse, abuse, improper wiring, incorrect voltage, operating the unit against the instructions in the owner's manual or any product which has been opened, altered, or tampered with.

This warranty does not cover costs for removal and or installation of the unit for repair. Under no circumstances shall the service center be liable for any special, incidental or consequential damages or for any other expenses incurred by reason of use or sale of this product. This warranty is in lieu of any other warranties expressed or implied warranty of merchantability of fitness for particular use or otherwise.

This warranty gives the consumer specific legal rights and they may also have other rights which vary from State to State. Some States do not follow the exclusion or limitation of incidental or consequential damages, hence the above exclusion and limitations may not apply.

Refurbished Product Service Center
13225 Marquardt Avenue Santa Fe Springs, CA 90670.

WARRANTY REPAIR INFORMATION

If you need service on your unit and this product requires repair during the 90 days warranty period; please go to www.ConsumerServiceRefurbish.com or call the **Refurbished Product Service Center** at 562-946-3531 to obtain the required return authorization (RA) number. Pack the unit properly (the original carton is ideal for this purpose) along with a copy of your purchase receipt and a letter describing the problem. Send the unit freight prepaid and insured to:

Refurbished Product Service Center,
Att: Customer Service Department 13225 Marquardt Avenue Santa Fe Springs, CA 90670
Your unit will be promptly repaired and returned to you.

We will refuse to accept delivery of the returned unit unless the assigned RA number appears on the outside of the shipping carton.

Owner's Information
(Keep for your permanent records)

NAME: _____

ADDRESS: _____

CITY: _____ STATE: _____ ZIP CODE: _____

PHONE: _____ E-MAIL: _____

MODEL: _____ SERIAL NO.: _____