

IMPORTANT SAFETY INFORMATION
READ ALL INSTRUCTIONS
BEFORE USING THE APPLIANCE

WARNING To reduce the risk of fire, electrical shock, injury to persons, or damage when using the air conditioner, follow basic precautions, including the following:

- Read all of the instructions before using this appliance.
- Plug into a grounded 3 prong outlet.
- Do not remove ground prong.
- Do not use an adapter.
- Do not use an extension cord.
- Do not operate the air conditioner if it has a damaged cord or plug, if it is not working properly, or if it has been damaged or dropped.
- GE Appliances does not support any servicing of sealed system components (i.e. refrigerant containing parts) in the air conditioner. Service of all other components may ONLY be completed by a qualified technician.

- Disconnect power before servicing.
- Disconnect power before cleaning.

NOTE: Turning off power by pressing the Power button does NOT disconnect the appliance from the power supply.

- Do not install or use the air conditioner in any area where the atmosphere contains combustible gases or where the atmosphere is contaminated. Avoid any chemicals coming in contact with your air conditioner.
- Do not store anything directly on top of the air conditioner.

- Use two or more people to move and install air conditioner.
- Never operate the air conditioner without the filters in place.

- Do not use the air conditioner near a bathtub, shower or wash basin or other wet area

WARNING Risk of Fire or Explosion. This unit contains flammable refrigerant.

Additional safety precautions must be followed.

- Do not use means to accelerate the defrosting process or to clean, other than those recommended by the manufacturer.
- The appliance shall be stored in a room without continuously operating ignition sources (for example, open flames, an operating gas appliance or an operating electric heater).
- Do not pierce or burn refrigerant tubing. Be aware that refrigerants may not contain an odor.
- Keep ventilation openings clear of obstruction.
- When handling, installing, and operating the appliance, care should be taken to avoid damage to the refrigerant tubing.
- Do not drill holes in the unit.
- Maintenance, cleaning, and service should only be performed by technicians properly trained and qualified in the use of flammable refrigerants.
- GE Appliances does not support any servicing of the air conditioner.
- Dispose of air conditioner in accordance with Federal and Local Regulations. Flammable refrigerants require special disposal procedures. Contact a service center.

WARNING How to Insert the Batteries in the Remote Control

- Remove the battery cover by sliding it according to the arrow direction.
- Insert new batteries, making sure that the (+) and (-) of battery are installed correctly.
- Reattach the cover by sliding it back into position.

NOTES:

- Use 2 "AAA" (1.5 volt) alkaline batteries. Do not use rechargeable batteries.
- Remove the batteries from the remote control if the system is not going to be used for a long time.
- Do not mix old and new batteries. Do not mix alkaline, standard (carbon-zinc) or rechargeable (ni-cad, ni-mh, etc) batteries.

WARNING Caution for Ingestion. The battery may cause suffocation if swallowed by children.

READ AND SAVE THESE INSTRUCTIONS



Portable Room
AIR CONDITIONER

804106818

USING THE AIR CONDITIONER
Controls

Features and appearance will vary. Lights next to the touch pads on the air conditioner control panel indicate the selected settings.

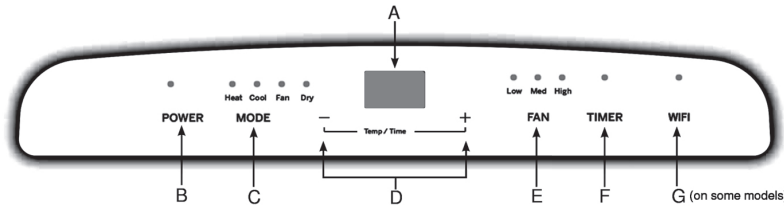

- A. Control Panel Display**
Displays the Set Temperature in degrees Fahrenheit. The corresponding indicator light will illuminate.
- B. Power Button**
Turns ON/OFF power to the air conditioner.
NOTE: Turning off power by pressing the Power button does NOT disconnect the appliance from the power supply.
• Press the Power button. The Power indicator will illuminate.
- C. Mode Button**
Press the Mode button to toggle among the operating options. The corresponding indicator will illuminate:
Heat (on some models) - Heats the room to the set temperature
Cool - Cools the room to the set temperature
DRY - Reduces the humidity in the room
Fan - Circulates the air in the room without cooling
- D. Timer / Temperature Set Controls**
Adjusts the Temperature or Hours in Time Delay.
To Set the Temperature:
The temperature can be set between 64°F and 86°F (18°C and 30° C) when the air conditioner is in Cool mode.
1. Press the Mode button until the Cool mode is selected.
2. Press the Up Arrow or Down Arrow buttons to select the Temperature.
NOTE: The temperature cannot be set when the air conditioner is in either Fan or DRY mode.
- E. Fan Speed Button**
The fan speed can be adjusted from Low, Medium, to High speed when the air conditioner is in operation.
NOTE: The fan speed cannot be adjusted when the unit is in DRY mode.
• Press the Fan Speed button to toggle among the three speeds. The corresponding fan speed indicator will illuminate.
- F. Timer Button**
Program a time from (1-hour to 24-hours) for the air conditioner to turn Off or On. When a Time Delay is programmed, the Timer indicator light will illuminate.
While the air conditioner is operating:
1. Press the Timer button.
2. Press the Up/Down arrow buttons to select the number of hours you want the air conditioner to continue to operate before turning Off.
NOTE: Wait approximately 5 seconds for the Turn-Off time to be saved.
While the air conditioner is off:
1. Press the Timer button.
2. Press the Up/Down arrow buttons to select the number of hours you want the air conditioner to remain off before turning On.
NOTE: Wait approximately 5 seconds for the Turn-On time to be saved.
To cancel the timer:
• Press the Timer button once, the hours remaining will flash, press the timer button again and the timer will be canceled.
- G. WiFi Connect Pad (on some Models)**
1. Press and hold the timer button for 3 seconds to connect the app or disconnect the app.
2. Connect your air conditioner to WiFi router. Refer to the "WiFi Set up" section for more information.

• The image shown here is for illustrative purposes only and may be subject to change. The actual descriptions of control panel and their locations may vary, depending on the model.

Set Temperature will be shown when unit is in operation.

Cool Mode

- Use the COOL mode for cooling.
To set the COOL mode:
1. Press the **MODE** pad until the **COOL** indicator light is lit.
 2. Press the **FAN** pad to set **HIGH, MEDIUM,** or **LOW** fan speed.
 3. Press **+ or -** to set the desired temperature between 64°F and 86°F in 1°F increments.

After settings have been made, the display will not change back to show the room temperature. The temperature control is used to maintain the room temperature. The compressor will cycle on and off to keep the room at the set level of comfort. Set the temperature control at a lower number and the indoor air will become cooler. Set the temperature control at a

higher number and the indoor air will become warmer.
NOTE: If the air conditioner is off and is then turned on while set to **COOL**, it will take approximately 3 minutes for the compressor to start and cooling to begin.

Cooling Descriptions
For Normal Cooling—Select the **COOL** mode and **HIGH, MEDIUM,** or **LOW** fan speed with a middle set temperature.
For Maximum Cooling—Select the **COOL** mode and **HIGH** fan speed with a lower set temperature.

For Quieter & Nighttime Cooling—Select the **COOL** mode and **LOW** fan speed with a middle set temperature.
NOTE: If you switch from **COOL** or **DRY** mode setting to **OFF**, wait 3 minutes before restarting.

DRY Mode—Dehumidification

Use the **DRY** mode to provide dehumidification only. The fan will run at a fixed speed at this setting, so a fan speed cannot be set. Keep windows and doors closed for the best dehumidifying effects.

- To set the DRY mode:**
• Press the **MODE** pad until the **DRY** indicator light is lit.
In the **DRY** mode, a set temperature will not be displayed. After **DRY** mode has been set, the display will change back to show the room temperature.
NOTE: If you switch from a **DRY** setting to **OFF** or to a

- fan setting, wait at least 3 minutes before switching back to a **DRY** setting.
If using the unit in the **DRY** mode as a dehumidifier for an extended time.
1. Unplug the power cord
2. Connect a ½" Outer diameter flexible drain hose to the drain port and drain to floor drain.
3. Reconnect the power cord and press the **MODE** pad until the **DRY** indicator light is lit.

FAN Mode

Use the **FAN** mode to provide air circulation and filtering without cooling.
To set the FAN mode:
• Press the **FAN** pad until the desired indicator light for high, medium, or low fan speed is lit.

Since fan only settings do not provide cooling, a set temperature will not be displayed. After **FAN** speed has been set, the display will change back to show the room temperature.
The exhaust hose and window kit do not need to be installed when operating in fan mode."

HEAT Mode

Use the **Heat** mode at Low, Med, High or Auto Fan Speed for heating. Use the Temperature Increase (+) / Decrease (-) pads to set the desired temperature between 64°F and 86°F in 1°F increments.

An electronic thermostat is used to maintain the room temperature. The heater will cycle on and off to keep the room at the set level of comfort.

Power Outage Recovery Feature

In the case of a power outage or interruption, the unit will automatically re-start in the settings last used after the power is restored.

NOTE: If the **TIMER** was set before the power outage, it will need to be reset after power is restored.

Features and appearance may vary. Icons on the remote control indicate the selected settings

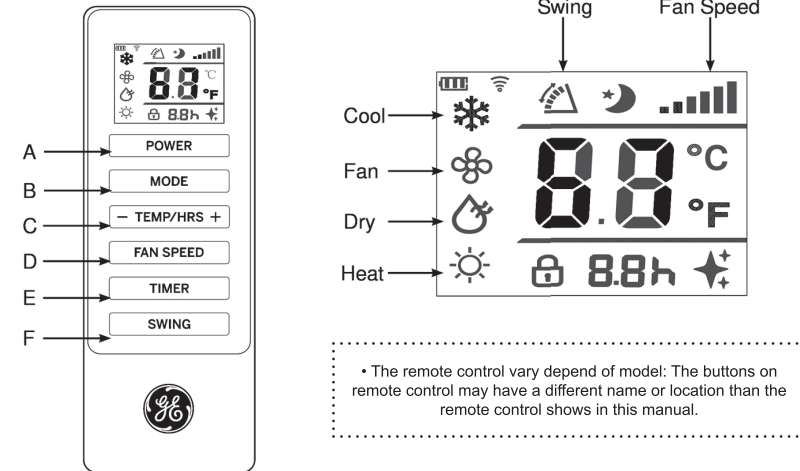

1. Insert the two batteries (not provided).
2. Aim the remote control at the signal receiver on the control panel to operate the air conditioner

- A. Power**
Turns ON/OFF power to the air conditioner.
NOTE: Turning off power by pressing the Power button does NOT disconnect the appliance from the power supply.
• Press the Power button. The Power indicator will illuminate.
- B. Mode**
Press the Mode button to toggle among the operating options. The corresponding indicator will illuminate:
Heat (on some models) - Heats the room to the set temperature
Cool - Cools the room to the set temperature
DRY - Reduces the humidity in the room
Fan - Circulates the air in the room without cooling

C. Temperature
Adjusts the Temperature or Hours in Time Delay.
To Set the Temperature:
The temperature can be set between 64°F and 86°F (18°C and 30°C) when the air conditioner is in Cool mode.

1. Press the Mode button until the Cool mode is selected.
2. Press the Up Arrow or Down Arrow buttons to select the Temperature.

D. Fan Speed
The fan speed can be adjusted from Low, Medium, to High speed when the air conditioner is in operation.
NOTE: The fan speed cannot be adjusted when the unit is in **DRY** mode.
• Press the Fan Speed button to toggle among the three speeds. The corresponding fan speed indicator will illuminate.

E. Timer
Program a time from (1-hour to 24-hours) for the air conditioner to turn Off or On. When a Time Delay is programmed, the Timer indicator light will illuminate.

F. Swing Button
The louvers on your portable air conditioner will open automatically (do not pry them open or push them shut). Use the Swing Button on your remote to adjust the louvers in the position you would like them to be in, or to operate in Swing mode the louvers will continue to move up and down.

NOTE: The temperature cannot be set when the air conditioner is in either Fan or **DRY** mode.

NOTE: The temperature cannot be set when the air conditioner is in either Fan or **DRY** mode.
NOTE: The fan speed cannot be adjusted when the unit is in **DRY** mode.
• Press the Fan Speed button to toggle among the three speeds. The corresponding fan speed indicator will illuminate.

NOTE: The temperature cannot be set when the air conditioner is in either Fan or **DRY** mode.
NOTE: The fan speed cannot be adjusted when the unit is in **DRY** mode.
• Press the Fan Speed button to toggle among the three speeds. The corresponding fan speed indicator will illuminate.

CARE AND CLEANING

CLEANING

WARNING

Electrical Shock Hazard

Disconnect power before cleaning.
Failure to do so can result in death or electrical shock.

1. Unplug or disconnect power.
2. Use only a soft cloth dampened with water to clean the cabinet.
NOTE:
•Do not use a liquid or spray cleaner to clean the air conditioner.
•DO NOT use chemicals, abrasives, ammonia, chlorine bleach, concentrated detergents, solvents or scouring pads. Some of these chemicals/items may damage and/or discolor your air conditioner.
3. Dry thoroughly with a soft cloth.
4. Plug in or reconnect power.

Air Filter

The air filters should be cleaned at least every two weeks for your unit to operate at optimum efficiency.

CAUTION DO NOT operate the air conditioner without a filter because dirt and lint will clog it and reduce performance.



- To remove:**
1. Unplug or disconnect power.
 2. Pull to remove upper filter panel.
 3. Wash or vacuum the dust from the air filters.
NOTE: If washed, gently shake the filter to remove the excess water and dust particles trapped in the filter.
 4. Reinstall the filters.
 5. Plug in or reconnect power.

Internal Water Tank

The Water Full indicator ("FL" on the control panel display) illuminates when the internal water tank has filled with condensed water

- To Empty the Internal Water Tank:
1. Unplug or disconnect power.
 2. Place a shallow 1 quart or larger pan (not included) below the lower drain located on the back (near the bottom) of the air conditioner.
 3. Remove the cap and the rubber plug and drain the water tank.
 4. Re-insert the drain plug and screw the cap snugly into place.
 5. Plug in or reconnect power.

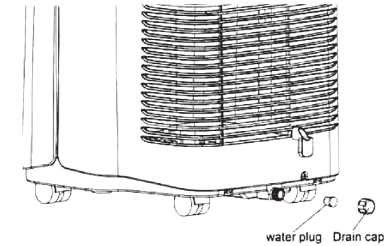

Storage

If the unit is not being used for a long period of time: To Empty the Internal Water Tank:

2. Drain the water from the water tank. (See "Internal Water Tank section" above.)
3. Use the original packaging to repack the unit to avoid a buildup of dust or dirt.
4. Store the air conditioner in a cool, dry location.

How to Insert the Batteries in the Remote Control (Batteries not supplied)

1. Remove the battery cover by sliding it according to the arrow direction.
2. Insert new batteries, making sure that the (+) and (-) of battery are installed correctly.
3. Reattach the cover by sliding it back into position.

NOTES:
■ Use 2 "AAA" (1.5 volt) alkaline batteries. Do not use rechargeable batteries.
■ Remove the batteries from the remote control if the system is not going to be used for a long time.
■ Do not mix old and new batteries. Do not mix alkaline, standard (carbon-zinc) or rechargeable (ni-cad, ni-mh, etc) batteries.

INSTALLATION INSTRUCTIONS

BEFORE YOU BEGIN

Read these instructions completely and carefully.

- **IMPORTANT** — Save these instructions for local inspector's use.
- **IMPORTANT** — Observe all governing codes and ordinances.
- **Note to Installer** – Be sure to leave these instructions with the Consumer
- **Note to Consumer** – Keep these instructions for future reference.
- **Skill level** – Installation of this appliance requires basic mechanical skills.
- **Completion time** – Approximately 1 hour
- We recommend that two people install this product.
- Proper installation is the responsibility of the installer.
- Product failure due to improper installation is not covered under the Warranty.
- You MUST use all supplied parts and use proper installation procedures as described in these instructions when installing this air conditioner.

ELECTRICAL REQUIREMENTS

Some models require a 115/120-volt AC, 60-Hz grounded outlet protected with a 15-amp time-delay fuse or circuit breaker.

The 3-prong grounding plug minimizes the possibility of electric shock hazard. If the wall outlet you plan to use is only a 2-prong outlet, it is your responsibility to have it replaced with a properly grounded 3-prong wall outlet.

CAUTION

Do not, under any circumstances, cut or remove the third (ground) prong from the power cord. Do not change the plug on the power cord of this air conditioner. Aluminium house wiring may present special problems—consult a qualified electrician.

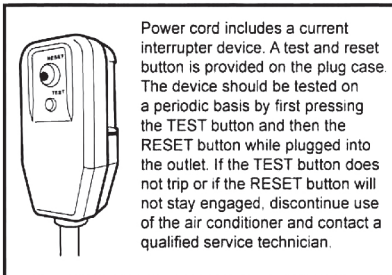

Power cord includes a current interrupter device. A test and reset button is provided on the plug case. The device should be tested on a periodic basis by first pressing the TEST button and then the RESET button while plugged into the outlet. If the TEST button does not trip or if the RESET button will not stay engaged, discontinue use of the air conditioner and contact a qualified service technician.

Location Requirements

- Place the air conditioner on a flat, level surface. For optimal performance place portable 20" from exterior wall. For all other sides a minimum distance of 30" should be maintained.
- Keep the air conditioner free of any obstructions such as drapes, curtains, blinds, etc.

Location Requirements

- The exhaust hose should be free of any obstructions.
- Do not place the air conditioner on an unstable or raised surface because it could fall and cause damage or injury.
- Do not place the air conditioner in direct sunlight or near a heat source such as baseboard heaters, stoves, etc.
- The window panel can be installed in a window with a minimum 20" (55.88 cm) to a maximum 46" (121.92 cm) opening.

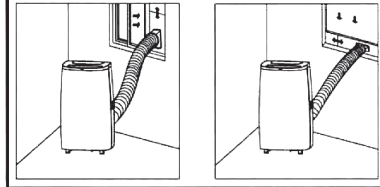

PARTS INCLUDED (Appearance may vary)

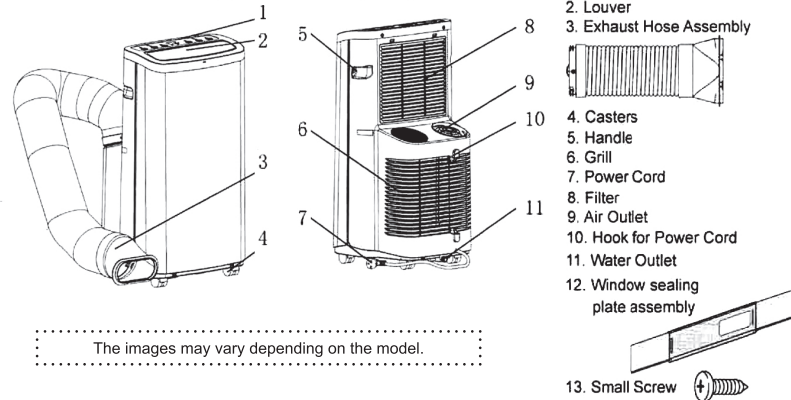

- Control Panel
- Louver
- Exhaust Hose Assembly
- Casters
- Handle
- Grill
- Power Cord
- Filter
- Air Outlet
- Hook for Power Cord
- Water Outlet
- Window sealing plate assembly
- Small Screw

The images may vary depending on the model.

1. UNPACK AIR CONDITIONER

WARNING

Excessive Weight Hazard

Use two or more people to move and install air conditioner.

Failure to do so can result in back or other injury.

- Remove packaging materials. Save the carton and the foam packaging for storing the air conditioner when not in use.

NOTE: There are NO packing materials inside the air conditioner to remove—Do Not open the cabinet.

- Properly dispose of/recycle all packing material.
- Handle the air conditioner gently.
- Keep the air conditioner upright and level. Do not set the air conditioner on its side, front, back or upside down.

2. Install Exhaust Hose Assembly to Back of Unit

Install the exhaust hose assembly by twisting the round adapter counterclockwise into the exhaust port on the back of the Air Conditioner.

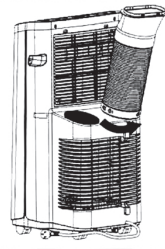

3. INSTALL WINDOW PANELS

A. Measure the window opening. For a 20" opening, use just the middle panel of the Window Kit with the opening for the Exhaust Hose Adapter. For openings from 20" to 33", insert one side panel to the middle panel, for openings from 33" to 46", insert both side panels.

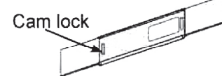

B. Place the Window Kit into the window opening (the Cam Locks should be towards you) and slide the side panels (if being used) outward to fill the opening. Lock the panels in place with the Cam Locks. Slide the window shut against the Window Kit.

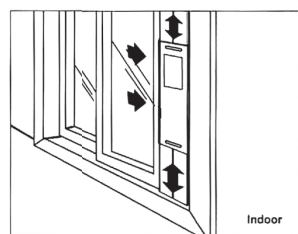
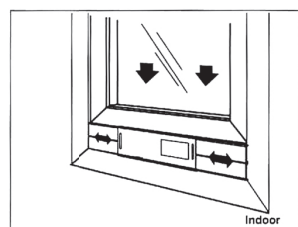

4. Connect Exhaust Hose to the Window Panel

Place the Air Conditioner close to the window ensuring there is at least 20" of clearance from the wall and any other obstructions. Extend the hose so that it reaches the Window Kit. Insert the Exhaust Hose Adapter into the opening in the Window Kit and slide it into the locking position. Ensure that the hose runs straight to the window with no excess extension. Use the small screw to attach the exhaust hose assembly to the window sealing plate assembly. **Important:** The Air Conditioner must be vented to the outside. Do not use a longer hose or extend the hose included with the Air Conditioner or the unit will not cool properly and will overheat.

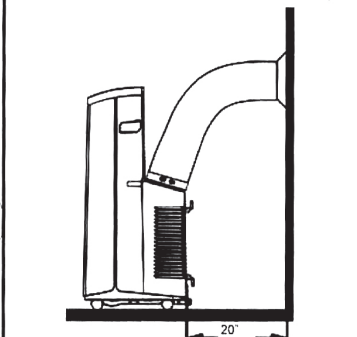
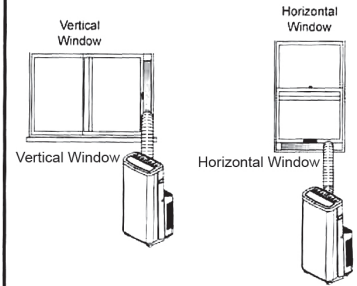

5. COMPLETE INSTALLATION

WARNING



Electrical Shock Hazard

Plug into a grounded 3 prong outlet. Do not remove the ground prong from the power cord plug. Do not use an adapter. Do not use an extension cord. Failure to do so can result in death, fire or electrical shock.

- Plug the power cord into a grounded 3 prong outlet.
- Press the Reset button on the plug to ensure the safety plug is providing power to the Air Conditioner.
- When removing the Air Conditioner, be sure to remove the Window Kit.

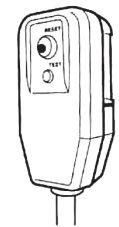

Error Codes

Error Codes	Meaning
E1	Abnormal sense of coil pipe sensor
E2	Abnormal sense of room temperature sensor
E4	Anti-frozen protection
FL	Full water

WiFi Setup (on some models)

GE Appliances WiFi Connect (for customers in the United States)

GE Appliances U+ Connect Enabled* If your Air Conditioner (AC) has a Connected Appliance Information label located on the outside as shown below, your AC is **GE Appliances U+ Connect Enabled**. A WiFi communication card is built into the product allowing it to communicate with your smart phone for remote monitoring, control and notifications. Please visit GEAppliances.com/connect to learn more about connected appliance features, and to learn what connected appliance apps will work with your smart phone.

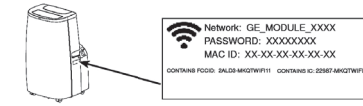

How it Works

Download the GE Appliances app

Use the app to connect your room air conditioner to WiFi

Once connected, use the app to turn down your air conditioner as you leave work.



Getting Started

To connect your room air conditioner, you'll need the GE Appliances app. The app will walk you through the connection process. Download the app from iTunes or Google Play.



All connected appliance data is held in strict accordance with GE Appliances Connected Data Privacy Policy. Visit geappliances.com/privacy/privacy_policy_connected to view this policy.

Questions about U+ Connect

Get answers you need about setting up WiFi appliances and connecting to your home network in our support articles.

Visit products.geappliances.com/appliance/gea-support-search-content to view wifi connect room air conditioner support articles.

REGULATORY INFORMATION

FCC/IC Compliance Statement:

This device complies with Part 15 of the FCC Rules. Operation is subject to the following two conditions:
1. This device may not cause harmful interference.
2. This device must accept any interference received, including interference that may cause undesired operation.

This equipment has been tested and found to comply with the limits for a Class B digital device, pursuant to Part 15 of the FCC Rules. These limits are designed to provide reasonable protection against harmful interference in a residential installation. This equipment generates uses and can radiate radio frequency energy and, if not installed and used in accordance with the instructions, may cause harmful interference to radio communications. However, there is no guarantee that interference will not occur in a particular installation. If this equipment does cause harmful interference to radio or television reception, which can be determined by turning the equipment off and on, the user is encouraged to try to correct the interference by one or more of the following measures:

- Reorient or relocate the receiving antenna.
 - Increase the separation between the equipment and receiver.
 - Connect the equipment into an outlet on a circuit different from that to which the receiver is connected.
 - Consult the dealer or an experienced radio/television technician for help.
- Labeling:** Changes or modifications to this unit not expressly approved by the manufacturer could void the users authority to operate the equipment.
*Select Models Only
This product has WiFi capability and requires Internet connectivity and a wireless router to enable interconnection with an Energy Management System, and/or with other external devices, systems or applications.
Use of the Works with Apple HomeKit™ logo means that an electronic accessory has been designed to connect specifically to iPod touch®, iPhone®, or iPad®, respectively, and has been certified by the developer to meet Apple® performance standards. Apple is not responsible for the operation of this device or its compliance with safety and regulatory standards.

The image shown here is for illustrative purposes only and may be subject to change.

Illustrations may differ from actual product. We are constantly striving to improve our products; therefore the specifications contained herein are subject to change without notice.

Troubleshooting Tips

Problem	Possible Causes	Solution
Unit does not start or operate	Power supply cord is not plugged into an outlet.	Plug the power cord into a grounded 3 prong outlet.
	Power supply cord has tripped.	Press and release the RESET button on the power supply cord.
	The Power button has not been pressed.	Press the Power button on the Control Panel or Remote Control to turn ON the air conditioner.
	There is no power to the electrical outlet.	Plug a working lamp into the outlet to check for power.
	A household fuse has blown or a circuit breaker has tripped.	Replace the fuse or reset the circuit breaker.
	The control was programmed for a Time Delay.	Cancel the Time Delay. See "Control Panel."
	The batteries in the remote control are dead.	Replace the batteries.
Remote control is not working	The internal water tank is full. NOTE: The air conditioner automatically turns off, and the Water Full indicator illuminates to alert you of this condition.	Empty the water tank. See "Air Conditioner Care."
	Batteries are dead.	Replace the batteries.
Air conditioner is working but the room is not cooling.	Batteries are installed incorrectly.	Make sure the batteries are inserted in the correct position.
	The room temperature is hot. NOTE: On extremely hot and humid days, the air conditioner will take longer to cool the room.	Allow time for the room to cool when you first turn on the unit. Make sure the air conditioner has an adequate BTU rating for the size of the room being cooled.
	The control is set incorrectly to Fan or DRY mode.	Set the Mode to Cool and the Fan Speed to High.
	Airflow is restricted.	Remove any obstacles to the airflow and redirect airflow for uniform cooling.
	Temperature set too high.	Lower the set temperature.
	Air filters are dirty or restricted.	Clean the air filter. See "Air Conditioner Care."
	Air conditioner installed incorrectly	Check the exhaust hose and window panel for proper installation.
	Doors and windows are open.	Close the doors and windows to the room being cooled to prevent cooled air from escaping.

REFURBISHED PRODUCT LIMITED THIRTY DAY WARRANTY

The **Refurbished Product Service Center** offers the following WARRANTY to the ORIGINAL purchaser of a product which we have refurbished.

This product that has been refurbished is warranted against any electronic or mechanical defects for a period of THIRTY DAYS from the date of the original purchase by the consumer. Since this unit was sold as a refurbished item, the warranty does not apply to any cosmetic appearance items such as scratches. Should a defect occur, the **Refurbished Product Service Center** will repair or, at its option, replace defective unit/parts with new or rebuilt materials without charge for either parts or labor. Replacement unit/parts will be warranted for the remaining portion of the original warranty period.

This warranty does not cover installation or damage from accident, misuse, abuse, improper wiring, incorrect voltage, operating the unit against the instructions in the owner's manual or any product which has been opened, altered, or tampered with.

This warranty does not cover costs for removal and/or installation of the unit for repair. Under no circumstances shall the service center be liable for any special, incidental or consequential damages or for any other expenses incurred by reason of use or sale of this product. This warranty is in lieu of any other warranties expressed or implied warranty of merchantability of fitness for particular use or otherwise.

This warranty gives the consumer specific legal rights and they may also have other rights which vary from State to State. Some States do not follow the exclusion or limitation of incidental or consequential damages, hence the above exclusion and limitations may not apply.

Refurbished Product Service Center
13225 Marquardt Avenue Santa Fe Springs, CA 90670

WARRANTY REPAIR INFORMATION

If you need service on your unit during the 30 day warranty period; please go to www.ConsumerServiceRefurbish.com or call the Refurbished Product Service Center at 562-946-3531 to obtain the required claim number. Once you obtain your claim number, pack the unit properly (the original carton is ideal for this purpose) along with a copy of your purchase receipt. Send the unit freight prepaid and insured to:

Refurbished Product Service Center,
Att: Customer Service Department 13225 Marquardt Avenue Santa Fe Springs, CA 90670

Your unit will be promptly exchanged and returned to you.

We will refuse to accept delivery of the returned unit unless the assigned claim number appears on the outside of the shipping carton.

Owner's Information
(Keep for your permanent records)

NAME: _____

ADDRESS: _____

CITY: _____

STATE: _____

ZIP CODE: _____

PHONE: _____

E-MAIL: _____

MODEL: _____

SERIAL NO.: _____

804106818



PRINTED IN MEXICO / SC:01-09-2022 / TAB
OBPN:49-5000636 Rev.0 10-21 GEA
Elbrd: J.E / SHNMDL:APCA14_B