

SONY Television

XR-83A80L / 83A80CL / 77A80L
XR-77A80CL / 65A80L / 65A80CL
XR-65A75L / 55A80L / 55A80CL
XR-55A75L

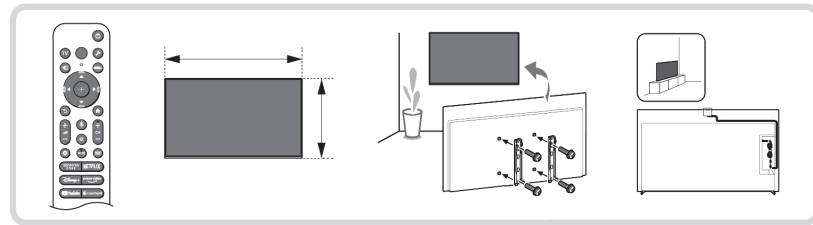

Dimensions and weight (without Table-Top Stand)

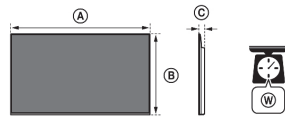

	(mm)/(inches)*1			(kg)/(lb.)*1
	A	B	C	W
XR-83A80L	1850 / 72 7/8	1067 / 42 1/8	53 / 2 1/8	42 / 92.6
XR-83A80CL	1850 / 72 7/8	1067 / 42 1/8	53 / 2 1/8	42 / 92.6
XR-77A80L	1722 / 67 7/8	998 / 39 3/8	54 / 2 1/4	34.8 / 76.7
XR-77A80CL	1722 / 67 7/8	998 / 39 3/8	54 / 2 1/4	34.8 / 76.7
XR-65A80L	1448 / 57 1/8	836 / 33	53 / 2 1/8	23.3 / 51.4
XR-65A80CL	1448 / 57 1/8	836 / 33	53 / 2 1/8	23.3 / 51.4
XR-65A75L	1448 / 57 1/8	836 / 33	53 / 2 1/8	22.9 / 50.5
XR-55A80L	1227 / 48 3/8	712 / 28 1/8	53 / 2 1/8	17.9 / 39.5
XR-55A80CL	1227 / 48 3/8	712 / 28 1/8	53 / 2 1/8	17.9 / 39.5
XR-55A75L	1227 / 48 3/8	712 / 28 1/8	53 / 2 1/8	17.8 / 39.3

*1 (Approx.)

Dimensions and weight (Table-Top Stand)

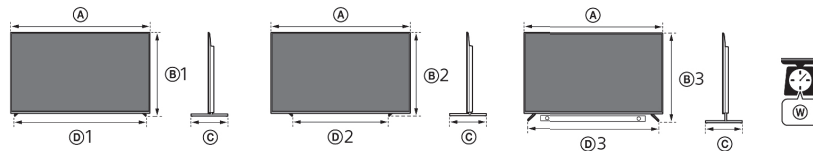

	(mm)/(inches)*1							(kg)/(lb.)*1	
	A	B1	B2	B3	C	D1	D2	D3	W
XR-83A80L	1850 / 72 7/8	1072 / 42 1/4	1099 / 43 3/8	1137 / 44 7/8	428 / 16 7/8	1880 / 74 1/8	700 / 27 3/8	1880 / 74 1/8	43.5 / 95.9
XR-83A80CL	1850 / 72 7/8	1072 / 42 1/4	1099 / 43 3/8	1137 / 44 7/8	428 / 16 7/8	1880 / 74 1/8	700 / 27 3/8	1880 / 74 1/8	43.5 / 95.9
XR-77A80L	1722 / 67 7/8	1024 / 40 3/8	1024 / 40 3/8	1066 / 42	389 / 15 3/8	1409 / 55 1/2	619 / 24 3/8	1409 / 55 1/2	37 / 81.5
XR-77A80CL	1722 / 67 7/8	1024 / 40 3/8	1024 / 40 3/8	1066 / 42	389 / 15 3/8	1409 / 55 1/2	619 / 24 3/8	1409 / 55 1/2	37 / 81.5
XR-65A80L	1448 / 57 1/8	862 / 34	862 / 34	904 / 35 5/8	330 / 13	1184 / 46 3/8	847 / 33 3/8	1184 / 46 3/8	24.9 / 54.9
XR-65A80CL	1448 / 57 1/8	862 / 34	862 / 34	904 / 35 5/8	330 / 13	1184 / 46 3/8	847 / 33 3/8	1184 / 46 3/8	24.9 / 54.9
XR-65A75L	1448 / 57 1/8	910 / 35 7/8	-	-	338 / 13 3/8	1052 / 41 1/2	-	-	24.2 / 53.4
	1448 / 57 1/8	910 / 35 7/8	-	-	338 / 13 3/8	1052 / 41 1/2	-	-	24.2 / 53.4
XR-55A80L	1227 / 48 3/8	738 / 29 1/8	738 / 29 1/8	780 / 30 3/4	330 / 13	1184 / 46 3/8	847 / 33 3/8	1184 / 46 3/8	19.5 / 43
XR-55A80CL	1227 / 48 3/8	738 / 29 1/8	738 / 29 1/8	780 / 30 3/4	330 / 13	1184 / 46 3/8	847 / 33 3/8	1184 / 46 3/8	19.5 / 43
XR-55A75L	1227 / 48 3/8	785 / 31	-	-	338 / 13 3/8	1052 / 41 1/2	-	-	19.1 / 42.1
	1227 / 48 3/8	785 / 31	-	-	338 / 13 3/8	1052 / 41 1/2	-	-	19.1 / 42.1

*1 (Approx.)

The length of the screw for Wall-Mount Bracket differs depending on the Wall-Mount Bracket thickness

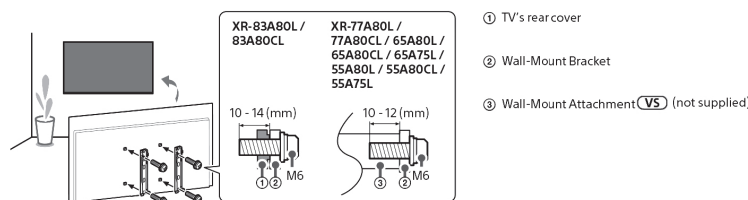

Optional Camera and Microphone Unit (not supplied) Cable Management



XR-83A80L / 83A80CL

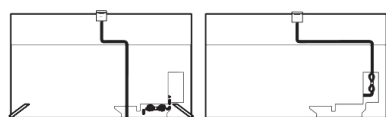

XR-77A80L / 77A80CL / 65A80L / 65A80CL / 65A75L / 55A80L / 55A80CL / 55A75L

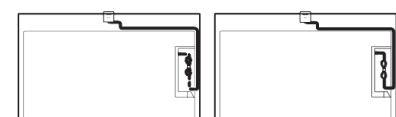

EN

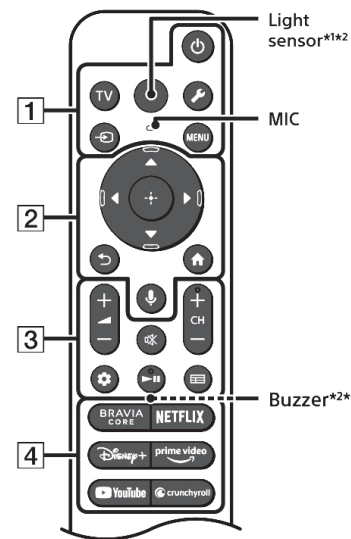

(Batteries not included)

The remote control shape, layout, availability and function of remote control buttons may vary depending on your region/country/TV model/TV settings.*4

- 1** **Power**
TV: Display TV channel list or switch to input.
Quick settings: Display Quick Settings.
Input: Display and select the input source, etc.
MENU (Control menu): Display the Control menu.
- 2** **Navigation and selection**
On screen menu navigation and selection.
Back
Home
Google Assistant / Microphone: Use Google Assistant**5*6.
- 3** **Volume**
Mute*7
CH + / - (Channel)
Dashboard: Display Dashboard.
Guide: Display the digital program guide of TV or Cable/satellite box**8.
- 4** **App buttons**

- The remote control backlight will illuminate when the light sensor detects the ambient light is low. Automatic illumination of the backlight can be turned off.
- RMF-TX910U only. To see the model name of the remote control, open the remote control cover and see the label on the remote control.
- The buzzer will emit a sound when you use the remote control finder function. Refer to the online Help Guide for details.
- For other remote control models, refer to the online Help Guide for details.
- Only for limited region/country/model/language.
- Google Assistant requires an Internet connection.
- Accessibility shortcut is available by pressing and holding **Mute**.
- [Cable/Satellite box setup] setting is required.

Note

- Instructions about "Installing the TV to the Wall" are included within this TV's instruction manual.
- Read the supplied safety documentation for additional safety information.

Location of the identification label
Labels for the TV Model No. and Power Supply rating are located on the rear of the TV. They can be found by removing the terminal cover.

IMPORTANT NOTICE FOR MEXICO
Operation of this equipment is subject to the following two conditions: (1) it is possible that this equipment or device may not cause harmful interference and (2) this equipment or device must accept any interference, including interference that may cause undesired operation.

For information related to the certificate number, refer to the package label and / or product.

Note:
This product uses the following module for wireless functionalities:
Model: DHUR-SY63
Brand: Wistron NeWeb Corporation
WLAN:
2.4 GHz (2.4000 GHz – 2.4835 GHz)
5 GHz (5.150 GHz – 5.850 GHz)
Bluetooth®:
2.4 GHz (2.4000 GHz – 2.4835 GHz)

Information for the remote control with voice command included with this product:
Model: RMF-TX810U*
Brand: Sony

Note: Uses the following device for wireless functionalities:
Model: UE878
Brand: UEI

* To see the model name of the remote control, open the remote control cover and see the label on the remote control.

Safety Information

Notice for customers in the United States of America

Supplier's Declaration of Conformity
Model: XR-83A80L / XR-83A80CL / XR-77A80L / XR-77A80CL / XR-65A80L / XR-65A80CL / XR-65A75L / XR-55A80L / XR-55A80CL / XR-55A75L
Responsible Party: Sony Electronics Inc.

Compatible Wall-Mount Bracket Information
Use the following Sony Wall-Mount Bracket with your TV model.

Sony TV Model No.	XR-77A80L / XR-77A80CL / XR-65A80L / XR-65A80CL / XR-65A75L / XR-55A80L / XR-55A80CL / XR-55A75L
Sony Wall-Mount Bracket Model No.	SU-WL855*1

Use with other Wall-Mount Brackets**2 may cause instability and could result in property damage or injury.

- Only for limited region/country/model.
- For instructions on using the Wall-Mount Bracket with your TV please go to <https://www.sony.com/am/support> for your TV model and download "Wall-Mount Bracket".

Before setting up your TV
Some TV models are packaged with a detached Table-Top Stand so you can mount your TV to a wall right away. See "Installing the TV to the Wall" if you want to mount the TV to a wall. If you are not mounting the TV to a wall, you will need to attach the Table-Top Stand (refer to the Setup Guide).
Be sure to consider the following while setting up your TV:

Note

- Instructions about "Installing the TV to the Wall" are included within this TV's instruction manual.
- Read the supplied safety documentation for additional safety information.

- Disconnect all cables when carrying the TV.
- Before transporting the TV set, remove the terminal covers.
- Two or more persons (three or more persons for 209.6 cm (83 inches) and above TV set) are needed to transport a large TV set.
- Correct hand placement while carrying the TV is very important for safety and to avoid damage.
- When handling or mounting the TV set, do not lay down the TV (for applicable TV model only).

XR-83A80L / 83A80CL

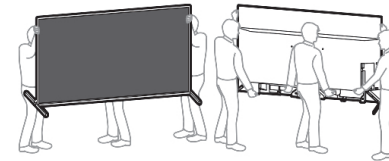

XR-77A80L / 77A80CL / 65A80L / 65A80CL / 65A75L / 55A80L / 55A80CL / 55A75L

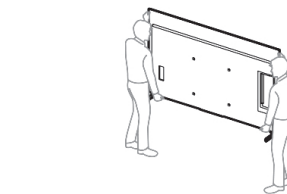

Securing the TV



Sony strongly recommends taking measures to prevent the TV from toppling over. Unsecured TVs may topple and result in property damage, serious bodily injury or even death.

Preventing the TV from Toppling

- Secure the TV to a wall and/or Stand.
- Do not allow children to play or climb on furniture and TV sets.
- Avoid placing or hanging items on the TV.
- Never install the TV on:
 - slippery, unstable and/or uneven surfaces.
 - furniture that can easily be used as steps, such as a chest of drawers.
- Install the TV where it cannot be pulled, pushed, or knocked over.
- Install the TV so that the TV's Table-Top Stand does not protrude out from the Stand (not supplied). If the Table-Top Stand protrudes out from the Stand, it may cause TV set to topple over, fall down, and cause personal injury or damage to the TV.

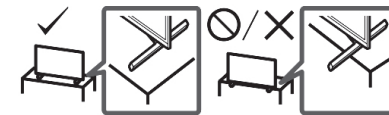

- Route all AC power cords and connecting cables so that they are not accessible to curious children.

Recommended Measures to Secure the TV

Consider the following measures when securing your TV to a Stand (not supplied).

- Secure the Stand for the TV.
Make sure the Stand can adequately support the weight of the TV. Use two angle braces (not supplied) to secure the Stand. For each angle brace use the appropriate hardware to:
 - Attach one side of the angle brace to the wall stud.
 - Attach the other side to the Stand.

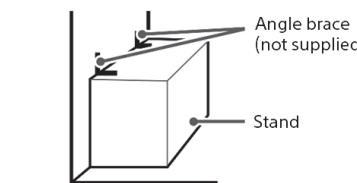

- Secure the TV to the Stand.
Use the optional hardware listed as follows (not supplied):
 - M6 machine screws (screwed into the TV's rear cover).
 - A screw or similar (attach it to the Stand).
 - Rope or chain (strong enough to support the weight of the TV). Make sure that there is no excess slack in the rope or chain.

XR-83A80L / 83A80CL

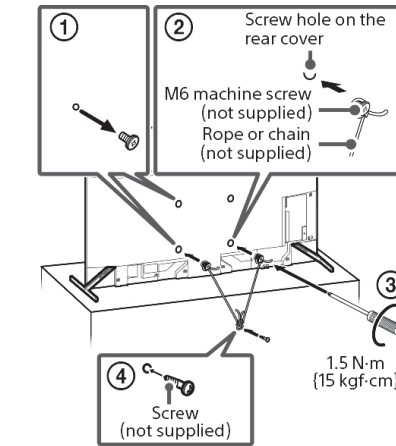

XR-83A80L / 83A80CL

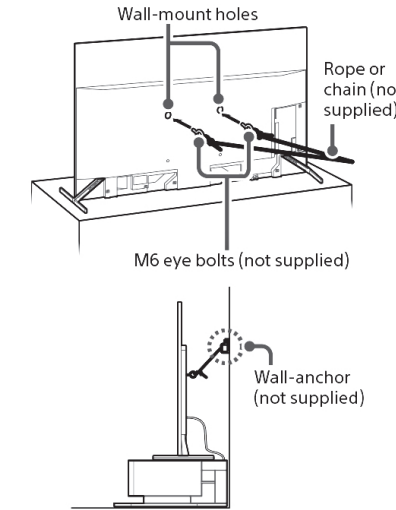

The BRAVIA® 4K TV Experience

Thank you for choosing Sony! Your new BRAVIA® TV opens the door to the "4K TV Experience". This document will help you get the most out of your TV. Please take a moment to register your TV at:
U.S.A.:
<https://productregistration.sony.com>
This TV displays all video input signals in a resolution of 3840 dots x 2160 lines.

Note

- For supported PC formats, refer to the online Help Guide.

Guidelines for IR Remote Control

- Point your remote control directly at the IR sensor located on your TV.
- Make sure that no objects are blocking the path between the remote control and the IR sensor on your TV.

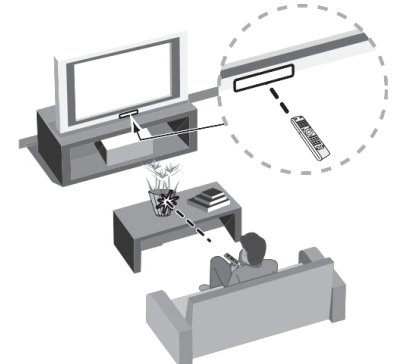

- Fluorescent lamps can interfere with your remote control; try turning off the fluorescent lamps.
- If you are having problems with the remote control, reinsert or replace your batteries and make sure that they are correctly inserted.

Installing the TV to the Wall

Wall mounting kit not included
Using the optional Wall-Mount Bracket (SU-WL855 only)* (not supplied)

Wall-Mount Bracket Installation Information

For instructions on Wall-Mount Bracket installation, see the Installation Information (Wall-Mount Bracket) on the Sony Customer Support website for your TV model at the following address.

- <https://www.sony.com/am/support>
- Follow the instruction guide provided with the Wall-Mount Bracket for your model. Sufficient expertise is required in installing this TV, especially to determine the strength of the wall for withstanding the TV's weight.
- Sony is not liable for any damage or injury caused by mishandling or improper installation.
- Be sure to store the unused screws and Table-Top Stand in a safe place until you are ready to attach the Table-Top Stand. Keep the screws away from small children.

Note

- Read the supplied safety documentation for additional safety information.

* Only for limited region/country/model.

Using the optional Wall-Mount Bracket (except SU-WL855) (not supplied)

This TV's instruction manual only provides the steps to prepare the TV for Wall-Mount installation before it is installed on the wall.

Your TV can be mounted to a wall using a suitable Wall-Mount Bracket (not supplied). If the Table-Top Stand is attached to the TV, the TV may require detaching the Table-Top Stand; see "Detaching the Table-Top Stand from the TV". Prepare the TV for the Wall-Mount Bracket before making cable connections.

For product protection and safety reasons, Sony strongly recommends that installation of your TV on the wall be performed by qualified professionals. Do not attempt to install it yourself.

- Follow the instruction guide provided with the Wall-Mount Bracket for your model. Sufficient expertise is required in installing this TV, especially to determine the strength of the wall for withstanding the TV's weight.
- The screws for installing the Wall-Mount Bracket to the TV are not supplied.
- Refer to the following table for wall-mount hole pattern.

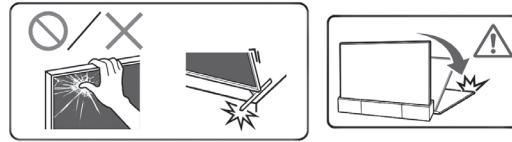

Setup Guide

Please Read this guide carefully before using the device and keep it for future reference.

1

SB1

SB2

★1

2

3

A

B

C

4

A

B

C

5

★1 Refer Reference Guide

★2 Only for limited region/country/model.

6

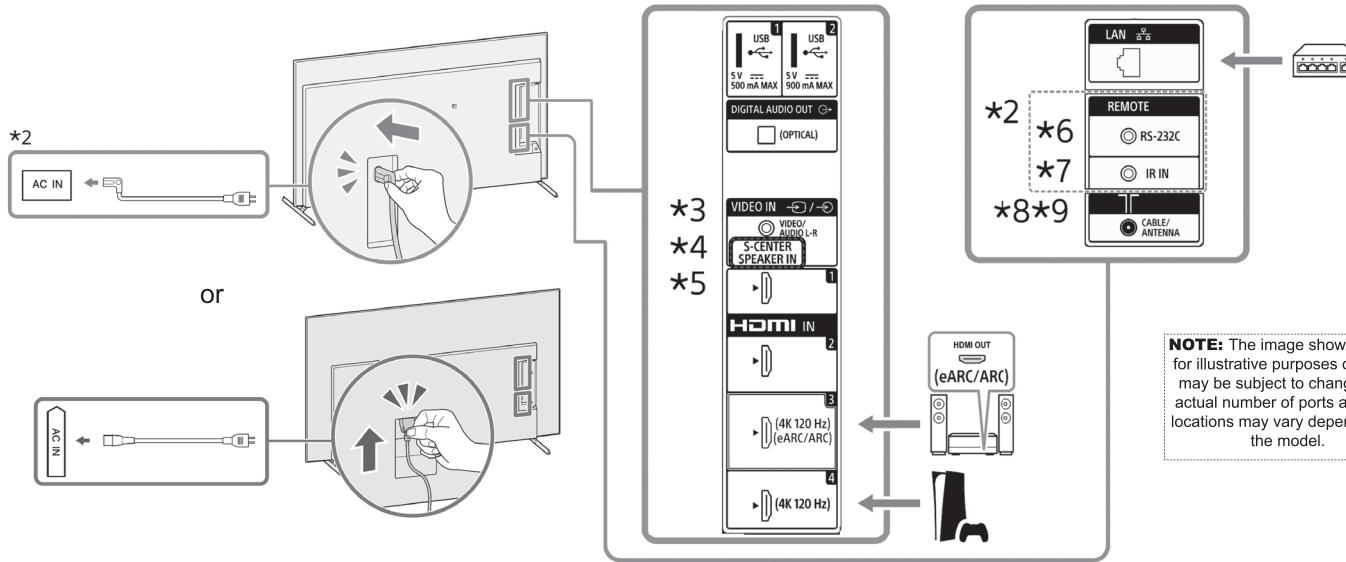

7

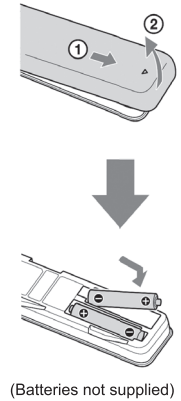

8

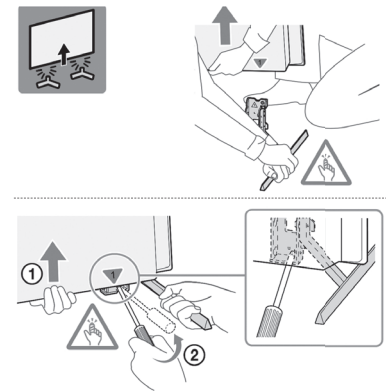
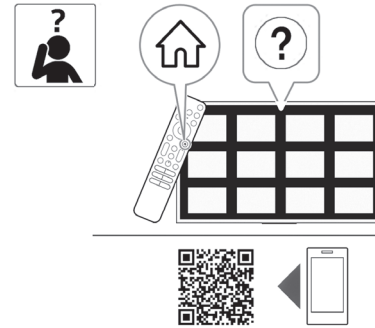
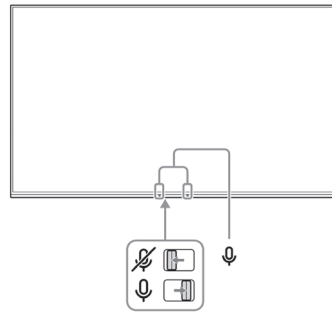
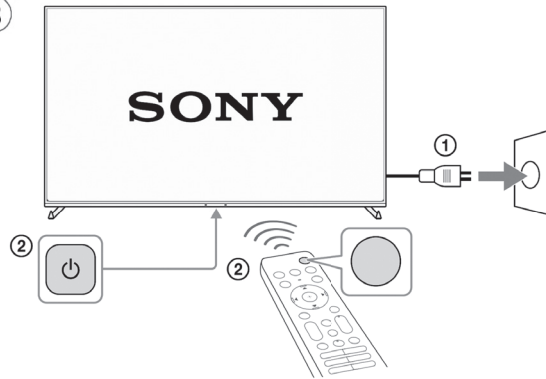

NOTE: The remote control vary depend of model: The buttons on the remote control may have a different name or location than the remote control shows in this manual.

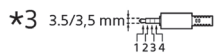

- 1: L / G
- 2: Video
- 3: GND
- 4: R / D

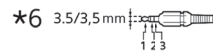
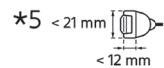
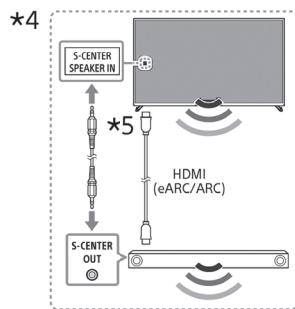

- 1: Tx/D
- 2: Rx/D
- 3: GND

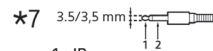

- 1: IR
- 2: GND

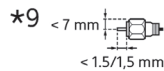
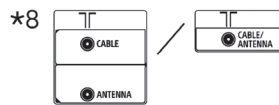

- Accessory type and quantity may vary depending on the model.
- The image shown here is for illustrative purposes only and may be subject to change.
- The cables mentioned in this guide is not supplied with your unit.

PRINTED IN MEXICO
 Elbrd: J.E. / SC: 09-26-2023_2P
 OBPn: 5-048-121-11(1)
 SHNMDL: KR65A80CL_B
 Add: XR55A80L / 55A80CL / 65A80L/
 XR77A80L/77A80CL

814000139

