

IMPORTANT SAFETY INSTRUCTIONS

HOUSEHOLD USE ONLY

To reduce the risk of electric shock, this vacuum cleaner has a polarized plug (one blade is wider than the other). As a safety feature, this plug will fit into a polarized outlet only one way. If the plug does not fit fully into the outlet, reverse the plug. If it still does not fit, contact a qualified electrician. **DO NOT** force into outlet or try to modify to fit.

WARNING

TO REDUCE THE RISK OF FIRE, ELECTRIC SHOCK OR INJURY:

GENERAL WARNINGS

- Your vacuum cleaner may consist of a motorized nozzle, wand, hose, and/or vacuum pod. This device contains electrical connections, electrical wiring, and moving parts that potentially present risk to the user.
 - Use only identical replacement parts.
 - Carefully observe and follow the instructions provided below to avoid improper use of the appliance. **DO NOT** use the vacuum for any purpose other than those described in this manual.
 - Before use, carefully inspect all parts for any damage. **DO NOT** use if any parts are damaged.
 - The use of an extension cord is **NOT** recommended.
 - This vacuum cleaner contains no serviceable parts.
- #### USE WARNINGS
- DO NOT** allow the appliance to be used by children. Close supervision is necessary when used near children. This is not a toy.
 - Always turn off the vacuum cleaner before connecting or disconnecting any motorized nozzles or other accessories.
 - DO NOT** handle plug or vacuum cleaner with wet hands.
 - DO NOT** use without filters in place.
 - Only use Shark[®] branded filters and accessories. Failure to do so will also void the warranty.
 - DO NOT** damage the power cord:
 - DO NOT** pull or carry vacuum cleaner by the cord or use the cord as a handle.
 - DO NOT** unplug by pulling on cord. Grasp the plug, not the cord.
 - DO NOT** run the vacuum cleaner over the power cord, close a door on the cord, pull the cord around sharp corners, or leave the cord near heated surfaces.
 - DO NOT** put any objects into nozzle or accessory openings. **DO NOT** use with any opening blocked; keep free of dust, lint, hair, and anything that may reduce airflow.
 - DO NOT** use if nozzle or accessory airflow is restricted. If the air paths or the motorized floor nozzle become blocked, turn the vacuum cleaner off and unplug from electrical outlet. Remove all obstructions before you plug in and turn on the unit again.
 - Keep nozzle and all vacuum openings away from hair, face, fingers, uncovered feet, or loose clothing.
 - DO NOT** use if vacuum cleaner is not working as it should, or has been dropped, damaged, left outdoors, or dropped into water.

- Use extra care when cleaning on stairs.
- DO NOT** leave the vacuum cleaner unattended while plugged in.
- When powered on, keep the vacuum cleaner moving over the carpet surface at all times to avoid damaging the carpet fibers.
- DO NOT** place vacuum cleaner on unstable surfaces such as chairs or tables.
- Your Shark[®] Vacuum may not be designed to stand up on its own. When taking a break from cleaning, you may need to lean it against furniture or a wall, or lay it flat on the floor. Using the vacuum for an application where the unit lacks stability may result in personal injury.
- DO NOT** use to pick up:
 - Liquids
 - Large objects
 - Hard or sharp objects (glass, nails, screws, or coins)
 - Large quantities of dust (drywall dust, fireplace ash, or embers). **DO NOT** use as an attachment to power tools for dust collection.
 - Smoking or burning objects (hot coals, cigarette butts, or matches)
 - Flammable or combustible materials (lighter fluid, gasoline, or kerosene)
 - Toxic materials (chlorine bleach, ammonia, or drain cleaner)
- DO NOT** use in the following areas:
 - Poorly lit areas
 - Wet or damp surfaces
 - Outdoor areas
 - Spaces that are enclosed and may contain explosive or toxic fumes or vapors (lighter fluid, gasoline, kerosene, paint, paint thinners, mothproofing substances, or flammable dust)
- Turn off all controls before plugging in or unplugging the vacuum.
- Unplug from electrical outlet when not in use and before any maintenance or cleaning.
- Hand wash with water only. Washing with cleaning chemicals could damage the unit.
- During cleaning or routine maintenance, **DO NOT** cut anything other than hair, fibers, or string wrapped around the brushroll.
- Allow all filters to air-dry completely before replacing in the vacuum to prevent liquid from being drawn into electric parts.
- Make sure the dust cup and all filters are in place after routine maintenance.
- If provided, secure the power cord around the two cord hooks during storage.

TECHNICAL SPECIFICATIONS

Voltage: 120V, 60Hz

SAVE THESE INSTRUCTIONS

READ ALL INSTRUCTIONS BEFORE USE

GETTING TO KNOW YOUR SHARK[®] APEX[®] DUOCLEAN[®] POWERED LIFT-AWAY[®]

MAIN UNIT

- Power Switch
- Handle Release Button
- Surface Selector
- Hose
- Upper Cord Hook
- Powered Lift-Away Button
- Wand Release Button
- Lift-Away Pod
- Dust Cup Release Button
- Dust Cup Empty Latches
- Wand
- Lower Cord Hook
- Motorized Floor Nozzle
- Brushroll Indicator Light
- Headlights
- Brushroll Garage
- Soft Roller

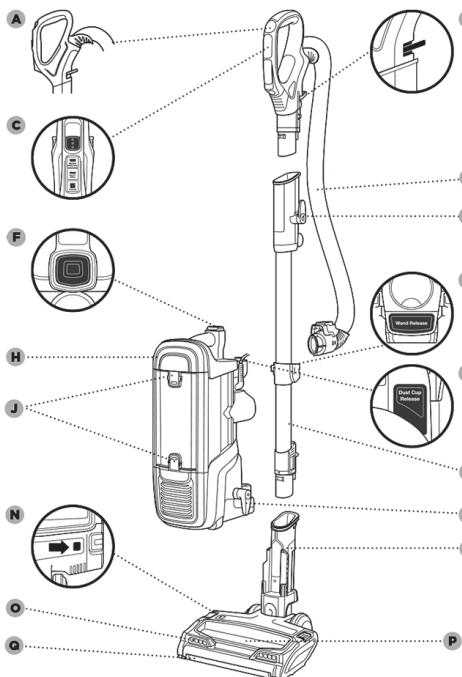

NOTE: Accessories may vary depending on the model.

ASSEMBLING YOUR VACUUM

TIP: For quick cord access, rotate upper hook down and remove cord.



TIP: Use cord clip located on the side of wand to hold cord in place while vacuuming.

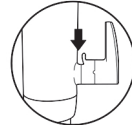

STEP 1

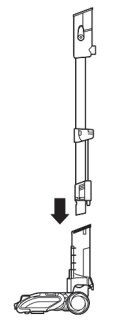

1 Place motorized floor nozzle on floor and insert wand, pressing it in until it clicks securely into place.

STEP 2

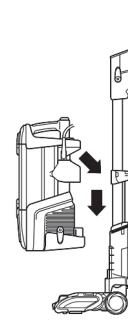

2 Place pod onto wand and slide down to connect.

STEP 3

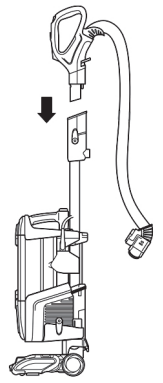

3 Insert handle into wand, pressing it in until it clicks securely into place.

STEP 4

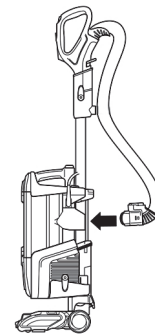

4 Connect hose into back of pod, pressing it in until it clicks securely into place.

STEP 5

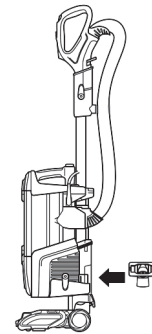

5 Store included accessories on the accessory posts on the pod.

The image shown here is for illustrative purposes only and may be subject to change.

NOZZLE MAINTENANCE

TIP: You can also check for blockages in the hose and tubes. Just remove the floor nozzle, dust cup, and hose and shine a flashlight in the openings.

Zero-M[™] Technology



Zero-M Technology[™] actively removes hair wrap from your brushroll while you vacuum, with uncompromised cleaning power. If you run over a hard or sharp object or notice a noise change while vacuuming, check for blockages or objects caught in the brushroll.

DuoClean[®] Technology

DuoClean Technology features a bristle brush to deep-clean carpets, and an additional soft brushroll to pull in larger particles and directly engage floors for a polished look. With normal use, you may need to perform routine maintenance of your Soft Roller. See the instructions below.

NOTE: Do not be alarmed if there is visible hair at any given time, as it will eventually make its way to the dust cup.

STEP 1

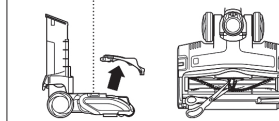
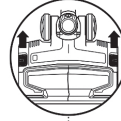

CLEANING THE BRUSHROLL

- To open the brushroll garage, slide both release buttons on the floor nozzle away from you, towards the back of the nozzle, then lift off the lid.
- Clear away any objects or debris.
- To close the brushroll garage, insert the 3 tabs on top of lid into the 3 slots in the nozzle, then push down on both sides of lid until it clicks securely into place. **If Brushroll Indicator Light isn't green and headlights are flashing, check again that both sides of lid are locked in place.**

STEP 2

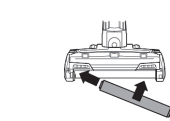
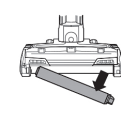

CLEANING THE SOFT ROLLER

- To remove Soft Roller from nozzle, lift it out by the pull tab.
- Tap loose debris off the Soft Roller. Use a dry towel to wipe the Soft Roller clean, or to remove any debris caught in the teeth behind the Soft Roller.
- Hand wash the Soft Roller as needed. Use only water, and let air-dry completely for at least 24 hours.
- Reinsert Soft Roller under rubber bumper in front of nozzle until it clicks into place.

CHECKING THE NOZZLE FOR BLOCKAGES

- Tilt neck of nozzle back to straighten the airway, then remove any blockages.

USING YOUR VACUUM IN UPRIGHT MODE

WHAT DOES THE BRUSHROLL INDICATOR LIGHT MEAN?

Solid Green
The brushrolls are spinning and working as they should.

Solid Red
There is a jam in the brushroll area. Turn off your vacuum and remove any blockages.

Flashing Red*
The motorized floor nozzle is overheating. Turn off your vacuum and wait for it to cool down. After vacuum has cooled, move surface selector switch to Thick Carpet/Area Rug mode, then press Power button to turn vacuum back on.

No Light
The brushrolls are not spinning because the vacuum is off.



*See Troubleshooting section for further instructions.

STEP 1

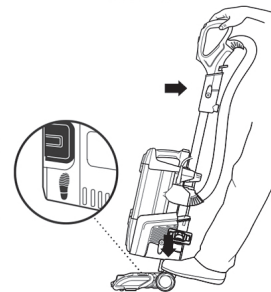

1 Plug power cord into outlet. Place foot on floor nozzle and tilt handle back.

STEP 2



2 Press power button to turn on vacuum. Please note the brushrolls will not spin unless the wand is reclined.

STEP 3

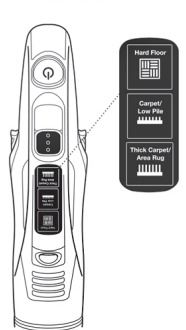

3 Choose the appropriate setting.

Thick Carpet & Area Rug Cleaning
Set surface selector to Thick Carpet/Area Rug.

Carpet & Low Pile Cleaning
Set surface selector to Carpet/Low Pile to increase the speed of your brushrolls and to help remove stuck-on dust and debris.

Hard Floor Cleaning
Set surface selector to Hard Floor.

NOTE: For deep cleaning per ASTM F 608 (embedded dirt in carpets) please set to Carpet/Low Pile.

TROUBLESHOOTING GUIDE

WARNING: To reduce the risk of shock and unintended operation, turn power off and unplug unit before servicing.



USING YOUR VACUUM IN ABOVE-FLOOR MODE

STEP 1

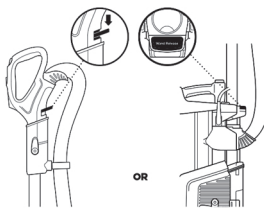

1 To clean above-floor areas with the handle, detach it from the wand by pressing the Handle Release button.

OR To clean with a longer reach, detach the wand from the floor nozzle by pressing the Wand Release button.

STEP 2

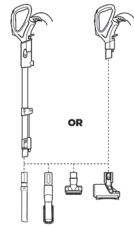

2 Insert desired tool directly onto wand or handle.

*Note: The Quick Guide shows the select accessories that are included with your model.

USING AND STORING YOUR ONBOARD MOTORIZED PET TOOL

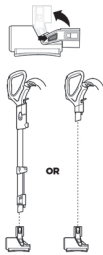

USING YOUR ONBOARD MOTORIZED PET TOOL

1 To use the tool, slide the Rotate button down, then rotate the cleaning head clockwise, until the head is in cleaning position, perpendicular to the base. Insert tool onto wand or handle.

STORING/REMOVING YOUR ONBOARD MOTORIZED PET TOOL

1 To store the tool on your vacuum, first press the Wand Release button to remove from the wand or handle.

2 Slide the Rotate button down, then rotate the cleaning head counterclockwise until the head is lined up with the base.

3 Place it on the left tool post (marked with tool icon) with orange Release button facing outwards. Push forward until the tool clicks into place.

4 To remove tool from post, press orange Release button and pull the tool towards you, away from the vacuum.

*Note: The Quick Guide shows the select accessories that are included with your model.

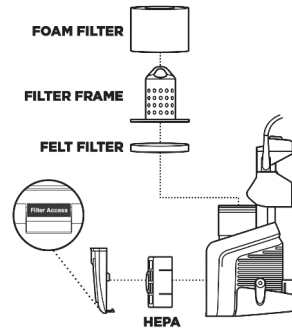

CLEANING THE FILTERS

1 Pre-Motor (foam and felt):

With the dust cup removed, take out the foam and felt filters, and rinse with water. Tap loose dirt off filters between washes as needed.

2 Post-Motor (HEPA):

To access the HEPA filter, reach under the grill, press the button, and pull the grill away from the vacuum. Remove and rinse the HEPA filter.

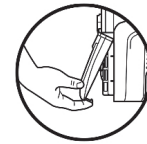

TROUBLESHOOTING GUIDE

⚠ WARNING: To reduce the risk of shock and unintended operation, turn power off and unplug unit before servicing.

This vacuum nozzle is specifically designed to pull in all types of debris and therefore can give the feeling of being self-propelled, especially on short carpets. To reduce the sensation of forward pull, set surface selector to either Hard Floor (for slower brushroll speed) or Thick Carpet/Area Rug (for less suction).

Vacuum is not picking up debris. No suction or light suction. (Refer to Maintenance section for more information.)

- Check filters to see if they need cleaning. Follow instructions for rinsing and drying the filters before reinserting in the vacuum.
- Dust cup may be full; empty dust cup.
- Check hose, hose connections, nozzle, and accessories for blockages; clear blockages if required.
- Remove any objects that may be impeding the brushrolls.

Vacuum lifts area rugs.

- Turn off unit to disengage the brushrolls. Be sure to select Thick Carpet/Area Rug setting.
- Suction is powerful. Take care when vacuuming area rugs or rugs with delicately sewn edges.

Brushroll and/or Soft Roller does not spin or the Brushroll Indicator Light turns red.

- Turn off vacuum, and move it away from any obstruction. If cleaning area rugs or thick carpet, ensure the appropriate setting is selected. Turn on vacuum and tilt handle back to activate brushroll.
- If Brushroll Indicator Light on floor nozzle remains red, turn off vacuum and unplug. Disconnect nozzle and remove any blockages. Make sure brushroll garage lid is firmly locked into position on both sides. Plug in vacuum, turn on power, and tilt handle back to activate brushroll. If Brushroll Indicator Light isn't green and headlights are flashing, check again that both sides of lid are locked in place.
- If Brushroll Indicator Light is still red, please contact a service center.

The Brushroll Indicator Light on the floor nozzle doesn't light up (either green or red) when you tilt the handle back.

- Turn off the unit. Move the handle back up into the upright lock position and unplug the vacuum. Make sure the brushroll garage lid is firmly locked into position on both sides. Plug in the vacuum and turn on power, then tilt handle back to activate brushroll. If the Brushroll Indicator Light on the floor nozzle turns green, the issue has been fixed.
- If Brushroll Indicator Light is still red, please contact a service center.

Vacuum turns off on its own or Brushroll Indicator Light flashes red.

- This vacuum is equipped with a motor-protective thermostat. If your vacuum overheats, the thermostat will automatically turn the suction motor off. Perform the following steps to reset the thermostat:
 1. Turn vacuum off and unplug it.
 2. Empty dust cup and clean filters (see Maintenance section).
 3. Check for blockages in hose, accessories, and inlet openings.
 4. Allow unit to cool for a minimum of 45 minutes.
 5. Plug in vacuum and turn it on.
- If hose is not fully connected to the pod, it can cause a poor electrical connection and the hose can come loose, turning the vacuum off.
 1. Turn vacuum off and unplug it.
 2. Empty dust cup and clean filters.
 3. Check for blockages in hose, accessories, and inlet openings.
 4. Remove cord from cord hook so hose latch can be seen and engaged.
 5. Ensure that hose, wand, and handle are all clicked securely into place at all connection points:
 - a. Where hose meets back of pod (may require additional force; pull on hose to ensure latch is fully engaged)
 - b. Where wand plugs into floor nozzle
 - c. Where handle plugs into wand
 6. Plug in vacuum and turn it on.

Note: If vacuum still does not run properly, please contact a service center.

REFURBISHED PRODUCT LIMITED NINETY DAYS WARRANTY

The **Refurbished Product Service Center** offers the following WARRANTY to the ORIGINAL purchaser of a product which we have refurbished.

This product that has been refurbished is warranted against any electronic or mechanical defects for a period of NINETY DAYS from the date of the original purchase by the consumer. Since this unit was sold as a refurbished item, the warranty does not apply to any cosmetic appearance items such as scratches. Should a defect occur, the **Refurbished Product Service Center** will repair or, at its option, replace defective unit/parts with new or rebuilt materials without charge for either parts or labor. Replacement unit/parts will be warranted for the remaining portion of the original warranty period.

This warranty does not cover installation or damage from accident, misuse, abuse, improper wiring, incorrect voltage, operating the unit against the instructions in the owner's manual or any product which has been opened, altered, or tampered with.

This warranty does not cover costs for removal and/or installation of the unit for repair. Under no circumstances shall the service center be liable for any special, incidental or consequential damages or for any other expenses incurred by reason of use or sale of this product. This warranty is in lieu of any other warranties expressed or implied warranty of merchantability of fitness for particular use or otherwise.

This warranty gives the consumer specific legal rights and they may also have other rights which vary from State to State. Some States do not follow the exclusion or limitation of incidental or consequential damages, hence the above exclusion and limitations may not apply.

Refurbished Product Service Center
13225 Marquardt Avenue Santa Fe Springs, CA 90670.

WARRANTY REPAIR INFORMATION

If you need service on your unit and this product requires repair during the 90 days warranty period; please go to www.ConsumerServiceRefurbish.com or call the **Refurbished Product Service Center** at 562-946-3531 to obtain the required return authorization (RA) number. Pack the unit properly (the original carton is ideal for this purpose) along with a copy of your purchase receipt and a letter describing the problem. Send the unit freight prepaid and insured to:

Refurbished Product Service Center,
Attn: Customer Service Department 13225 Marquardt Avenue Santa Fe Springs, CA 90670

Your unit will be promptly repaired and returned to you. We will refuse to accept delivery of the returned unit unless the assigned RA number appears on the outside of the shipping carton.

Owner's Information
(Keep for your permanent records)

NAME: _____
ADDRESS: _____
CITY: _____ STATE: _____ ZIP CODE: _____
PHONE: _____ E-MAIL: _____
MODEL: _____ SERIAL NO.: _____

USING YOUR VACUUM IN POWERED LIFT-AWAY® MODE

WHAT IS POWERED LIFT-AWAY?

Our Powered Lift-Away feature allows you to remove the pod from the nozzle while maintaining the same power you have in upright mode. This is great for cleaning stairs, under furniture, and in other tight spaces.

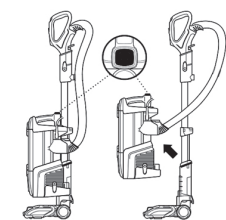

POWERED LIFT-AWAY CLEANING

1 Press Powered Lift-Away button to lift pod off wand. You are now ready to clean those hard-to-reach places.

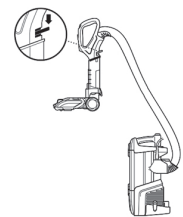

2 For a convenient way to clean stairs, detach wand and handle, then insert handle into motorized floor nozzle.



LIFT-AWAY® CLEANING

1 Attach desired accessory directly to the handle. For more cleaning reach, attach the wand to the handle, then attach accessory to the wand.

COMPATIBLE ACCESSORIES

There are a variety of accessories that are compatible with this vacuum series.

The Quick Start Guide shows which accessories are included with your model.

A Mini Motorized Pet Brush

Designed to remove pet hair and ground-in dirt from carpeted stairs and upholstery.

B 12" Crevice Tool

Clean in corners and other tight spaces or reach baseboards and ceilings with this slim crevice tool.

C Pet Multi-Tool

Two tools for cleaning tough pet messes: first, a stiff bristle brush for cleaning stuck-on debris. Then remove the bristles to reveal an upholstery tool for cleaning stubborn pet hair.

D Anti-Allergen Dust Brush

Features specially designed nylon fiber bristles for removing fine dust and allergen particles from the most delicate surfaces.

E Onboard Motorized Pet Tool

Compact motorized brush powerful enough to remove deeply embedded allergens, dirt, and pet hair from multiple surfaces. Stores onboard for your convenience.

F MultiFLEX™ Under-Appliance Wand

Pivoting wand that extends to clean under appliances and on top of furniture.

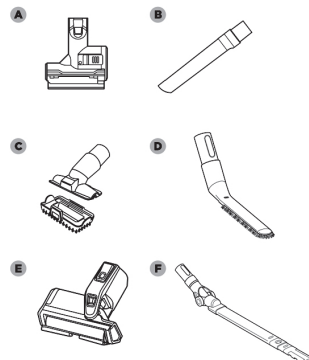

*Note: Accessory may vary depending on the model.

FILTER MAINTENANCE

To keep your vacuum's suction power optimal, follow these instructions. Make sure unit is off and cord is unplugged.

★ IMPORTANT: Do not use soap when cleaning the filters. Do not scrub HEPA filter material.

RECOMMENDED FILTER CLEANING SCHEDULE:

Pre-Motor Filter Kit (Foam & Felt)
XFF650
Clean every 3 months.

Post-Motor Filter (HEPA)
XHF650
Clean once a year.

STEP 1

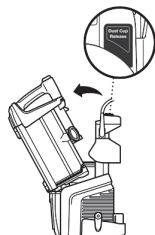

EMPTYING THE DUST CUP

1 Press down on Dust Cup Release button and lift dust cup off pod.

STEP 2

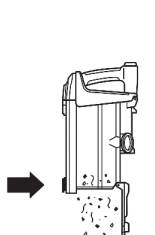

2 Hold dust cup over a trash bin and press the latch on the bottom of the dust cup to empty it.

STEP 3

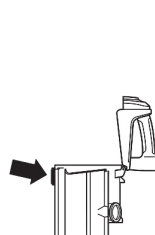

3 Press top Dust Cup Empty latch to access dust screen and remove built-up debris as required.

Shark APEX

QUICK START GUIDE

duo clean WITH ZERO-M TECHNOLOGY
Powered Lift-Away

WHAT'S INSIDE:

- A Handle
- B Hose
- C Vacuum Pod
- D Wand
- E Motorized Floor Nozzle
- F Upholstery Tool
- G Pet Power Brush
- H Crevice Tool

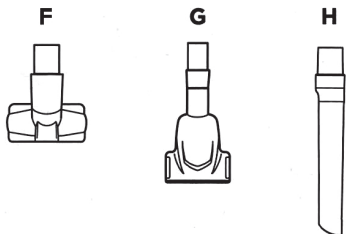

1. Insert wand into floor nozzle.
2. Insert handle into wand.
3. Place pod onto wand.
Slide down to connect.

ASSEMBLY

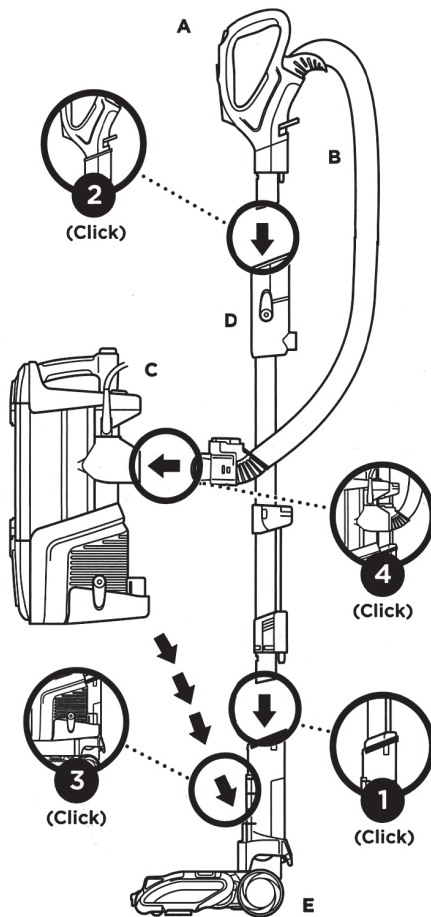

The images shown here are for illustrative purposes only and may be subject to change.

VERSATILE FLOOR-TO-CEILING CLEANING

UPRIGHT MODE

Place your foot gently on the floor nozzle and tilt the handle back. Choose floor type and press power button.

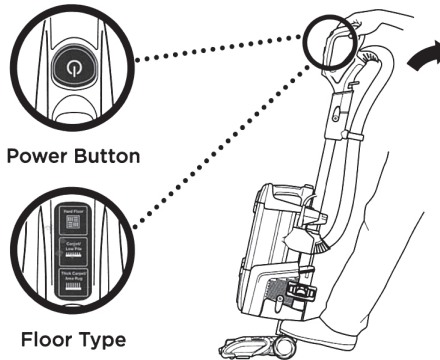

Power Button

Floor Type



Hard Floor: Gentle on bare floors and delicate area rugs.

Carpet/Low Pile: Optimized brushroll speed and suction for carpets.

Thick Carpet/Area Rug: Optimized brushroll speed and suction for thick carpets.

POWERED LIFT-AWAY® MODE

Press Lift-Away Release button to lift pod off wand to clean hard-to-reach places.

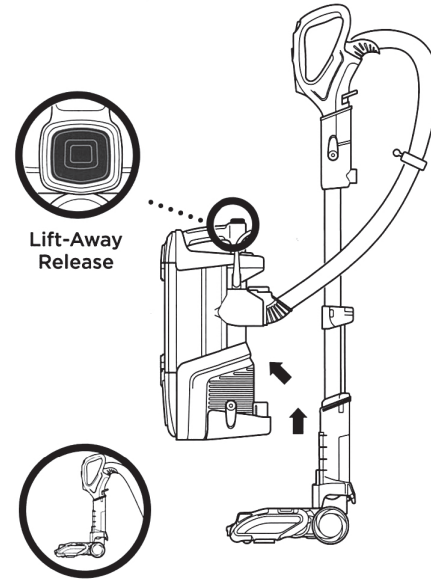

Lift-Away Release

DUOCLEAN® TECHNOLOGY

ON FLOORS

Direct engagement with the Soft Roller removes large particles, small particles, and stuck-on dust.

Hard Floor

Gentle on bare floors and delicate area rugs.

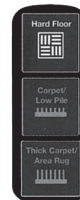
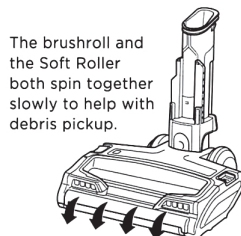

ON CARPETS

The Soft Roller pulls in large particles, while the deep-cleaning bristle brush removes embedded fine dirt.

Carpet/Low Pile

Optimized brushroll speed and suction for carpets.

Thick Carpet/Area Rug

Suction for thick carpets and area rugs.

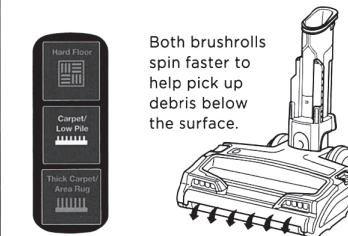

MAINTENANCE

Empty dust cup after each use

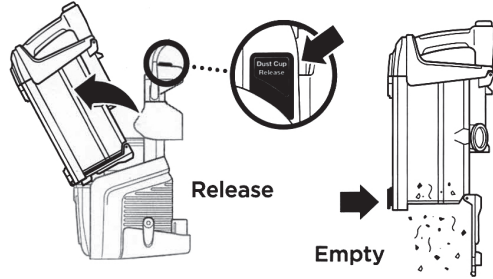

Zero-M™ Technology

With Zero-M technology, the brushroll actively removes hair wrap while you vacuum, sending it to the dust cup. To clear any blockages, see instructions below.

Cleaning the Brushroll

1. To open the brushroll garage, slide both release buttons on the floor nozzle away from you, towards the back of the nozzle, then lift off the lid.
2. Clear away any objects or debris.
3. To close the brushroll garage, insert the 3 tabs on top of lid into the 3 slots in the nozzle, then push down on both sides of lid until it clicks securely into place. If Brushroll Indicator Light isn't green and headlights are flashing, check again that both sides of lid are locked in place.

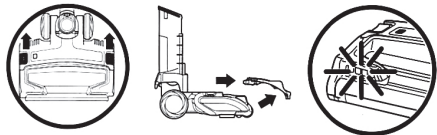

Filter Maintenance

Wash filters regularly to keep the suction strong.
Rinse filters with water only, and allow them to air-dry completely before reinstalling. Tap loose dirt from foam filters as needed between washes.

Brushroll Maintenance

Carefully remove any debris that may be impeding the brushroll.

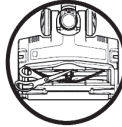

Cleaning the Soft Roller

Lift out the Soft Roller by pulling the tab on the right side. Clear away any debris, then slide the Soft Roller back into place.

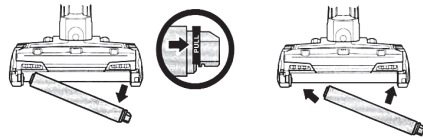

Checking the Nozzle for Blockages

Tilt neck of nozzle back to straighten the airway, then remove any blockages.

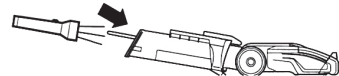

HAVING TROUBLE?

ISSUE

Vacuum is not picking up debris. No suction or light suction.

Solution

Empty dust cup, clean filters, check all openings for blockages.

ISSUE

Vacuum lifts area rugs.

Solution

Turn off the unit to disengage the brushroll and restart with the Power button.

ISSUE

Brushroll and/or Soft Roller does not spin. The Brushroll Indicator Light on the floor nozzle turns red.

Solution

Turn off the unit and move away from any obstruction, then turn on power and tilt handle back. If the light remains red, turn off and unplug the vacuum. Disconnect the nozzle and remove any blockages. Make sure the brushroll lid is firmly

locked into position on both sides. Plug in the vacuum, turn on power, and tilt handle back. If Brushroll Indicator Light isn't green and headlights are flashing, check again that both sides of the lid are locked into place. If the light is still red, please contact a Service Center.

PRINTED IN MEXICO
SC:31.05.19
2P
Ebrd:J.E.
SHNMDL: AZ1002_B
OBPN:AZ1002_QSG_MP_REV_181214

804009316B

