

NINJA®

FOODI® SMOOTHIE BOWL MAKER & NUTRIENT EXTRACTOR*

OWNER'S GUIDE

804106681

It's important to read this Owner's Guide prior to using your product for the first time.



Recipe book is not included.

IMPORTANT SAFEGUARDS

HOUSEHOLD USE ONLY • READ ALL INSTRUCTIONS BEFORE USE

	Read and review instructions for operation and use.
	Indicates the presence of a hazard that can cause personal injury, death or substantial property damage if the warning included with this symbol is ignored.
	For indoor and household use only.
When using electrical appliances, basic safety precautions should always be followed, including the following:	

WARNING

To reduce the risk of fire, electric shock, serious injury, death, or damage when using this appliance, follow these basic safety precautions.

General Precautions

- Read all instructions prior to using the appliance and its accessories.
- Carefully observe and follow all warnings and instructions. This unit contains electrical connections and moving parts that potentially present risk to the user.
- ALWAYS** exercise care when handling the Hybrid Edge™ Blades Assembly. The blades are sharp, handle carefully. **ONLY** grasp the Hybrid Edge Blades Assembly by the outer perimeter of the blade assembly base. Failure to use care when handling the blade assembly will result in a risk of laceration.
- Take your time and exercise care during unpacking and appliance setup. This appliance contains sharp, loose blades that can cause injury if mishandled.
- Take inventory of all contents to ensure you have all parts needed to properly and safely operate your appliance.
- Blades are sharp. Handle carefully.
- Unplug the appliance from the outlet when not in use, before assembling or disassembling parts, and before cleaning. To unplug, grasp the plug by the body and pull from the outlet. **NEVER** unplug by grasping and pulling the flexible cord.
- Before use, wash all parts that may contact food. Follow washing instructions covered in this instruction manual.
- To protect against the risk of electric shock, **DO NOT** submerge the appliance or allow the power cord to contact any form of liquid.
- DO NOT** use this appliance outdoors. It is designed for indoor household use only.
- This appliance has important markings on the plug blade. The attachment plug or entire cordset (if plug is molded onto cord) is not suitable for replacement. If damaged, the appliance shall be replaced.
- This appliance has a polarized plug (one prong is wider than the other). To reduce the risk of electric shock, this plug will fit in a polarized outlet only one way. If the plug does not fit fully in the outlet, reverse the plug. If it still does not fit, contact a qualified electrician. **DO NOT** modify the plug in any way.
- DO NOT** operate any appliance with a damaged cord or plug, or after the appliance malfunctions or is dropped or damaged in any manner. This appliance has no user-serviceable parts. If damaged, contact a service center.
- Extension cords should **NOT** be used with this appliance.
- DO NOT** allow children to operate this appliance or use as a toy. Close supervision is necessary when any appliance is used near children.
- This appliance is **NOT** intended to be used by people with reduced physical, sensory, or mental capabilities, or lack of experience and knowledge, unless they have been given supervision or instruction concerning use of the appliance by a person responsible for their safety.
- Before each use, inspect blade assembly for damage. If a blade is bent or damage is suspected, contact a service center.
- DO NOT** attempt to sharpen blades.
- DO NOT** allow the unit or the cord to hang over the edges of tables or counters. The cord may become snagged and pull the appliance off the work surface.
- DO NOT** allow any part of the unit to contact hot surfaces, including stoves and other heating appliances.
- ALWAYS** use the appliance on a dry and level surface.
- NEVER** place a blade assembly on the motor base without it first being attached to the cup.
- Keep hands, hair, and clothing out of the container when loading and operating
- ONLY** use attachments and accessories that are provided with the product or are recommended by SharkNinja. The use of attachments not recommended or sold by SharkNinja may cause fire, electric shock, or injury.
- During operation and handling of the appliance, avoid contact with moving parts.
- DO NOT** operate the appliance with an empty container.
- DO NOT** fill containers past the **MAX FILL** or **MAX LIQUID** lines.
- DO NOT** microwave any containers or accessories provided with the appliance.
- DO NOT** perform grinding operations.
- Before operation, ensure all utensils are removed from containers. Failure to remove utensils can cause containers to shatter and potentially result in personal injury and property damage.
- NEVER** operate the appliance without lids and caps in place. **DO NOT** attempt to defeat the interlock mechanism. Ensure the container and lid are properly installed before operation.
- DO NOT** expose the containers and accessories to extreme temperature changes. They may experience damage.
- NEVER** leave the appliance unattended while in use.
- DO NOT** blend hot liquids. Doing so may result in pressure buildup and steam exposure that can pose a risk of the user being burned.
- If you find unmixed ingredients sticking to the sides of the cup, stop the appliance, remove the blade assembly, and use a scraper to dislodge ingredients.
- DO NOT** attempt to remove the container and lids from the motor base while the blade assembly is still spinning. Allow the appliance to come to a complete stop before removing lid and container.
- Remove the Hybrid Edge™ Blades Assembly from the Ninja® Foodi® XL Smoothie Bowl Maker and Nutrient Extractor* upon completion of blending. **DO NOT** store ingredients before or after blending them in the cup with the blade assembly attached. Some foods may contain active ingredients or release gases that will expand if left in a sealed container, resulting in excessive pressure buildup that can pose a risk of injury. For ingredient storage in the bowl, use only Spout Lid or Storage Lid.
- If the appliance overheats, a thermal switch will activate and temporarily disable the motor. To reset, unplug the appliance and allow it to cool for approximately 15 minutes before using again.
- The maximum wattage rating for this appliance is based on the configuration of the Hybrid Edge Blades Assembly and Ninja Nutrient Extraction* Cup. Other configurations may draw less power or current.
- DO NOT** process dry ingredients without adding liquid to the Ninja Nutrient Extraction* Cup or Ninja XL Smoothie Bowl Maker. They are not intended for dry blending.
- To protect against risk of electrical shock, **DO NOT** immerse the motor base in water or other liquid. Unplug the motor base before cleaning.

*Extract a drink containing vitamins and nutrients from fruits and vegetables.

SAVE THESE INSTRUCTIONS

GETTING TO KNOW YOUR NINJA®

PARTS

- A** Spout Lid
- B** 24 oz. Ninja Nutrient Extraction* Cup
- C** Storage Lid
- D** 18 oz. Ninja XL Smoothie Bowl Maker (with built-in tamper)
- E** Hybrid Edge™ Blades Assembly
- F** Motor Base (attached power cord not shown)

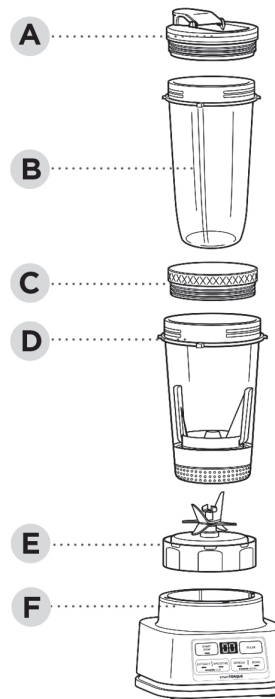

NOTE: The Hybrid Edge Blades Assembly is not compatible with other Ninja products.

NOTE: Number of cups, bowls and lids vary by model.

BEFORE FIRST USE

IMPORTANT: Review all warnings before proceeding.

NOTE: Handle the Hybrid Edge Blades Assembly by grasping around the perimeter of the blade assembly base.

NOTE: All attachments are BPA free and dishwasher safe. It is recommended that the containers, lids, and blade assembly be placed on the top rack of the dishwasher. Ensure blade assembly and lid are removed from the container before placing in the dishwasher. Exercise care when handling blade assembly.

- Remove all packaging materials from the unit. Exercise care when unpacking blade assembly, as the blades are sharp.
- Wash containers, lids, and blade assembly in warm, soapy water using a dishwashing utensil with a handle to avoid direct contact with the blades. Exercise care when handling blade assembly, as the blades are sharp.
- Thoroughly rinse and air-dry all parts.

NOTE: Accessories may vary depending on the model. Refer to quick guide, if available. The images shown here are for illustrative purposes only and may be subject to change.

USING THE CONTROL PANEL

AUTO-IQ® PROGRAMS

Intelligent preset programs combine unique blending and pausing patterns that do the work for you. Once a preset program is selected, it will start immediately and automatically stop when blending is complete. To stop blending before the end of the program, press the currently active button again.



AUTO-IQ PROGRAMS:

EXTRACT

Ideal for tough, leafy, or fibrous whole fruits and vegetables, including their skins, seeds, and stems.

SMOOTHIE

Combine your favorite fresh or frozen ingredients, liquids, and powders to create smoothies and proteins shakes.

SPREAD

Create anything from spreadable nut butters to zesty dressing to the perfect hummus.

BOWL

Make thick, spoonable smoothie bowls, creamy frozen yogurt, and refreshing sorbets.

NOTE: For the best results when using the XL Smoothie Bowl Maker, use the Spoonable Auto-iQ Programs, BOWL and SPREAD.

MANUAL PROGRAMS:

NOTE: Manual programs cannot be used in conjunction with any Auto-iQ programs.

START/STOP

Press once to start continuous running up to 60 seconds; press again to stop. Can also be pressed to stop a running Auto-iQ program.

PULSE

Offers greater control of pulsing and blending. Operates only when PULSE is pressed. Use short presses for short pulses and long presses for long pulses.

USING THE NINJA® XL SMOOTHIE BOWL MAKER

- Plug in motor base and place on a clean, dry, level surface such as a countertop or table.
- Add liquid then ingredients to the XL Smoothies Bowl Maker. **DO NOT** add liquid past the **LIQUID FILL** line or ingredients past the **MAX FILL** line.
- Place the Hybrid Edge™ Blades Assembly on the top of the bowl and turn clockwise to seal.

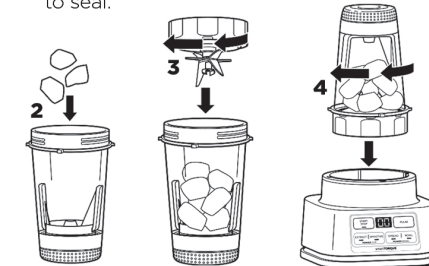

- Turn the bowl upside down and install on motor base by aligning the tabs on the bowl with the slots on the base. Then, rotate bowl clockwise until it clicks. Once locked in place, the programs will illuminate and the unit will be ready for use.

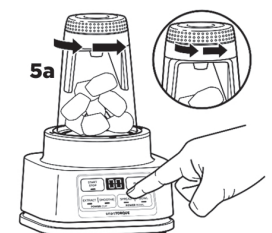

NOTE: While processing, twist the Power Paddle counter-clockwise continuously.

- If using an Auto-iQ® program, select the program that best suits your desired output. During the blending process, twist the Power Paddle counter-clockwise continuously. The preset feature will automatically stop at the end of the program. To stop the unit at any time, press the currently active program again.

TECHNICAL SPECIFICATIONS

Voltage: 120V~60Hz

USING THE NINJA® XL SMOOTHIE BOWL MAKER-CONT...

5b If using START/STOP, once the ingredients have reached your desired consistency, press START/STOP again, and wait for the unit to come to a complete stop. During the blending process, make sure to twist the Power Paddle **counterclockwise** continuously.

6 Remove the bowl from the motor base by turning it counterclockwise and then lifting up.

7 Remove the blade assembly by twisting counterclockwise. **DO NOT** store blended contents with the blade assembly attached. Only use the Spout Lid or Storage Lid to cover. Exercise care when handling the blade assembly, as the blades are sharp.

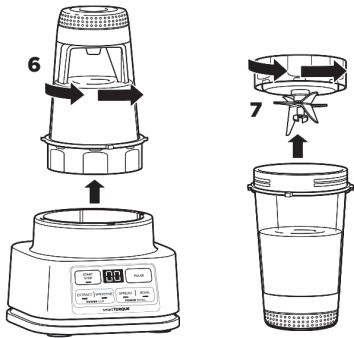

8 To enjoy on the go, place the Spout Lid or Storage Lid onto the bowl and twist lid clockwise until firmly sealed.

9 Unplug the unit when finished. Refer to the Care & Maintenance section for cleaning and storage instructions.

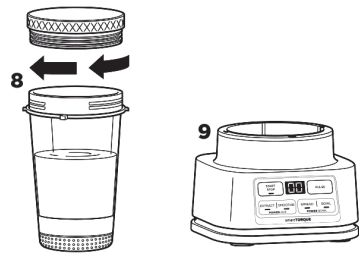

The images shown here are for illustrative purposes only and may be subject to change.

USING THE NINJA® NUTRIENT EXTRACTION* CUP

IMPORTANT: Review all warnings before proceeding.

1 Plug in motor base and place on a clean, dry, level surface such as a countertop or table.



2 Add ingredients to the Nutrient Extraction* Cup. **DO NOT** add ingredients past the **MAX FILL** line.



3 Place the Hybrid Edge™ Blades Assembly on the top of the cup and turn clockwise to seal.

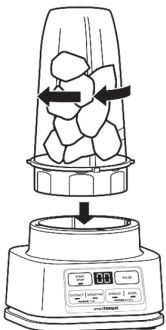

4 Turn the cup upside down and install on the motor base by aligning the tabs on the cup with the slots on the base. Then, rotate cup clockwise until it clicks. Once locked in place, the programs will illuminate and the unit will be ready for use.

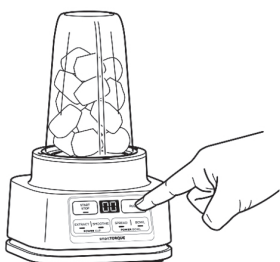

5a If using an Auto-iQ® program, select the program that best suits your desired output. The preset feature will automatically stop at the end of the program. To stop the unit at any time, press the currently active program again.

5b If using START/STOP, once the ingredients have reached your desired consistency, press START/STOP again, and wait for the unit to come to a complete stop.

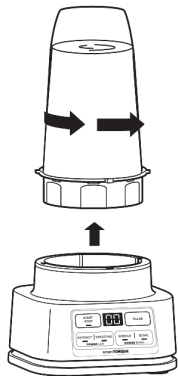

6 Remove the cup from the motor base by turning it counterclockwise and then lifting up.



7 Remove the blade assembly by twisting counterclockwise. **DO NOT** store blended contents with the blade assembly attached. Only use the Spout Lid or Storage Lid to cover. Exercise care when handling the blade assembly, as the blades are sharp.



8 To enjoy on the go, place the Spout Lid or Storage Lid onto the cup and twist lid clockwise until firmly sealed.



9 Unplug the unit when finished. Refer to the Care & Maintenance section for cleaning and storage instructions.

CARE & MAINTENANCE

CLEANING

Hand-Washing

Wash containers, lids, and blade assembly in warm, soapy water. Use a dishwashing utensil with handle to avoid direct contact with the blades. Exercise care when handling the blade assembly as the blades are sharp. Thoroughly rinse and air-dry all parts.

NOTE: The built-in tamper in the XL Smoothie Bowl Maker is not removable.

STUCK-ON INGREDIENTS IN THE XL SMOOTHIE BOWL MAKER

1-2 SMALL DROPS OF DISH SOAP

FILL WATER TO TOP OF PADDLE



For stuck-on ingredients, such as nut butter, rinse the bowl and blade assembly under warm water.

Next, fill the bowl with warm water up to the top of the paddle and add 1-2 small drops of dish soap.

Screw on the blade assembly and press BOWL. Twist the Power Paddle counterclockwise continuously while cleaning.

Then, empty contents and rinse under warm water and wipe with a dishwashing utensil, if needed.

Dishwasher

Containers, lids, and blade assembly are top-rack dishwasher safe **ONLY**. Ensure the blade assembly and lid are removed from the container before placing in the dishwasher.

Motor Base

Unplug the unit before cleaning. Wipe motor base with a clean, damp cloth.

STORING

For cord storage, wrap cord with hook-and-loop fastener near the back of the motor base. **DO NOT** wrap the cord around the bottom of the base for storage.

DO NOT store blended or unblended ingredients in the cup or bowl with the blade assembly attached. Use only the spout lid or storage lid when storing blended or unblended ingredients in the containers.

DO NOT stack items on top of the containers. Store any remaining attachments alongside the unit or in a cabinet where they will not be damaged or create a hazard.

RESETTING THE MOTOR THERMOSTAT

This unit features a unique safety system that prevents damage to the motor and drive system should you inadvertently overload it. If the unit is overloaded, the motor will be temporarily disabled. Should this occur, follow the reset procedure below.

- 1 Unplug the unit from the electrical outlet.
- 2 Allow the unit to cool for approximately 15 minutes.
- 3 Remove the blade assembly from the container. Empty the container and ensure no ingredients are jamming the blade assembly.

IMPORTANT: Ensure that maximum capacities are not exceeded. This is the most typical cause of appliance overload.

TROUBLESHOOTING GUIDE

WARNING: To reduce the risk of shock and unintended operation, unplug unit before troubleshooting.

Display reads "--".

- If vessel is properly installed and the display reads "--", ensure the interior of the base area is clean of any debris.

Control panel does not illuminate.

- Make sure unit is plugged in. If the unit is powered on and no container is installed, the unit will display "--". The available programs will illuminate after placing a container on base and rotating it clockwise until it clicks into place.

Control panel doesn't turn off.

- Remove container from base by rotating it counterclockwise and lifting it up. The display with flash "--". Unplug the power cord from the outlet. If the unit remains plugged in, the display will time out after 3 minutes of inactivity. Press any button to wake the unit.

Doesn't mix well; ingredients get stuck.

- Using the Auto-iQ® programs is the easiest way to achieve great results. The pulses and pauses allow the ingredients to settle toward the blade assembly. If ingredients are routinely getting stuck, adding some liquid will usually help.
- When filling the cup, start with fresh fruit or veggies, then leafy greens or herbs. Next add liquids or yogurt, then seeds, powders, or nut butters. Finally, add ice or frozen ingredients.
- If using the XL Smoothie Bowl Maker, during the blending process twist the built-in tamper counterclockwise continuously to circulate ingredients.

Unit moves on counter while blending.

- Make sure the counter and feet of the unit are clean and dry.

Lid or Hybrid Edge™ Blades Assembly is hard to install on the container.

- Set the container on a level surface. Carefully place the lid or blade assembly on the top of the container and align the threads so the lid/blade assembly sits flat. Twist clockwise until you have a tight seal.

Can't remove the tamper from the XL Smoothie Bowl Maker.

- The tamper is built-in and is not removable from a XL Smoothie Bowl Maker. For cleaning instructions, refer to the Care & Maintenance section.

REFURBISHED PRODUCT LIMITED NINETY DAYS WARRANTY

The **Refurbished Product Service Center** offers the following WARRANTY to the ORIGINAL purchaser of a product which we have refurbished.

This product that has been refurbished is warranted against any electronic or mechanical defects for a period of NINETY DAYS from the date of the original purchase by the consumer. Since this unit was sold as a refurbished item, the warranty does not apply to any cosmetic appearance items such as scratches. Should a defect occur, the **Refurbished Product Service Center** will repair or, at its option, replace defective unit/parts with new or rebuilt materials without charge for either parts or labor. Replacement unit/parts will be warranted for the remaining portion of the original warranty period.

This warranty does not cover installation or damage from accident, misuse, abuse, improper wiring, incorrect voltage, operating the unit against the instructions in the owner's manual or any product which has been opened, altered, or tampered with.

This warranty does not cover costs for removal and or installation of the unit for repair. Under no circumstances shall the service center be liable for any special, incidental or consequential damages or for any other expenses incurred by reason of use or sale of this product. This warranty is in lieu of any other warranties expressed or implied warranty of merchantability of fitness for particular use or otherwise.

This warranty gives the consumer specific legal rights and they may also have other rights which vary from State to State. Some States do not follow the exclusion or limitation of incidental or consequential damages, hence the above exclusion and limitations may not apply.

Refurbished Product Service Center
13225 Marquardt Avenue Santa Fe Springs, CA 90670.

WARRANTY REPAIR INFORMATION

If you need service on your unit and this product requires repair during the 90 days warranty period; please go to www.ConsumerServiceRefurbish.com or call the **Refurbished Product Service Center** at 562-946-3531 to obtain the required return authorization (RA) number. Pack the unit properly (the original carton is ideal for this purpose) along with a copy of your purchase receipt and a letter describing the problem. Send the unit freight prepaid and insured to:

Refurbished Product Service Center,
Att: Customer Service Department 13225 Marquardt Avenue Santa Fe Springs, CA 90670

Your unit will be promptly repaired and returned to you. We will refuse to accept delivery of the returned unit unless the assigned RA number appears on the outside of the shipping carton.

Owner's Information
(Keep for your permanent records)

NAME: _____
ADDRESS: _____
CITY: _____ STATE: _____ ZIP CODE: _____
PHONE: _____ E-MAIL: _____
MODEL: _____ SERIAL NO.: _____



PRINTED IN MEXICO
OBPN: CO101BSeries_IB_MP_Mv4_210507
SC: 21-01-2022_TAB MODEL: CO101B_B

