

IMPORTANT SAFEGUARDS

HOUSEHOLD USE ONLY. READ ALL INSTRUCTIONS.

When using electrical appliance, basic safety precautions should always be followed, including the following:

⚠ WARNINGS

- This appliance can be used by persons with reduced physical, sensory or mental capabilities or lack of experience and knowledge if they have been given supervision or instruction concerning use of the appliance in a safe way and understand the hazards involved.
- Keep the appliance and its cord out of reach of children. **DO NOT** allow the appliance to be used by children. Close supervision is necessary when used near children.
- Children should not play with the appliance.
- NEVER** use electrical socket below counter.
- To prevent fire, **DO NOT** place appliance on or near a gas or electric stovetop, or in a heated oven.
- NEVER** connect this appliance to an external timer switch or separate remote-control system.
- When using this appliance, provide at least 6 inches (15.25 cm) of space above and on all sides for air circulation.
- DO NOT** cover the air intake vent or air outlet while unit is operating. Doing so will prevent even cooking and may damage the unit or cause it to overheat.
- To protect against electrical shock **DO NOT** immerse cord, plugs, or main unit housing in water or other liquid. Cook only in the basket provided.
- Regularly inspect the appliance and power cord. **DO NOT** use the appliance if there is damage to the power cord or plug. If the appliance malfunctions or has been damaged in any way, immediately stop use and contact a Service Center.
- DO NOT** use an extension cord. A short power-supply cord is used to reduce the risk of children grabbing the cord or becoming entangled and to reduce the risk of people tripping over a longer cord.
- ALWAYS** ensure the appliance is properly assembled before use.
- Before placing removable basket into the main unit, ensure basket and unit are clean and dry by wiping with a soft cloth.
- This appliance is for household use only. **DO NOT** use this appliance for anything other than its intended use. **DO NOT** use in moving vehicles or boats. **DO NOT** use outdoors. Misuse may cause injury.
- Intended for worktop use only. Ensure the surface is level, clean and dry. **DO NOT** move the appliance when in use.
- DO NOT** place the appliance near the edge of a worktop during operation.
- DO NOT** use accessory attachments not recommended or sold by SharkNinja. Do not place accessories in a microwave, toaster oven, convection oven, or conventional oven or on a ceramic cooktop, electric coil, gas burner range or outdoor grill. The use of accessory attachments not recommended by SharkNinja may cause fire, electric shock or injuries.
- ALWAYS** ensure basket is properly closed before operating.
- DO NOT** use the appliance without the removable basket installed.
- DO NOT** use this appliance for deep-frying.
- Prevent food contact with heating elements. **DO NOT** overfill when cooking. Overfilling may cause personal injury or property damage or affect the safety of the appliance.
- DO NOT** place items on top of unit at any time.
- Socket voltages can vary, affecting the performance of your product. To prevent possible illness, use a thermometer to check that your food is cooked to the temperatures recommended.
- Should the unit emit black smoke, unplug immediately. Wait for smoking to stop before removing any cooking accessories.
- DO NOT** touch hot surfaces. Appliance surfaces are hot during and after operation. To prevent burns or personal injury, **ALWAYS** use protective hot pads or insulated oven mitts and use available handles.
- Extreme caution must be used when the appliance contains hot food. Improper use may result in personal injury.
- This appliance has a polarized plug (one blade is wider than the other). To reduce the risk of electric shock, this plug is intended to fit into a polarized outlet only one way. If the plug does not fit fully into the outlet, reverse the plug. If it still does not fit, contact a qualified electrician. **DO NOT** attempt to modify the plug in any way.
- Spilled food can cause serious burns. Keep appliance and cord away from children. **DO NOT** let cord hang over edges of tables or counters or touch hot surfaces.
- The basket and crisper plate become extremely hot during the cooking process. Avoid physical contact while removing the basket or plate from the appliance. **ALWAYS** place basket or plate on a heat-resistant surface after removing. **DO NOT** touch accessories during or immediately after cooking.
- Cleaning and user maintenance should not be carried out by children.
- To disconnect, press the power button to turn off the unit, then unplug from socket when not in use and before cleaning. Allow to cool before cleaning, disassembly, putting in or taking off parts and storage.
- DO NOT** clean with metal scouring pads. Pieces can break off the pad and touch electrical parts, creating the risk of electric shock.
- Please refer to the Cleaning & Maintenance section for regular maintenance of the appliance.
- DO NOT** place hands near food Smart Thermometer cord when in use to prevent burning or scalding.
- The Foodi Smart Thermometer does **NOT** replace an external food thermometer.
- To prevent possible illness, **ALWAYS** use an external food thermometer to check that your food is cooked to the recommended temperatures.
- Allow to cool before cleaning, disassembly, putting in or taking off parts and storage.

- Indicates to read and review instructions to understand operation and use of product.
- Indicates the presence of a hazard that can cause personal injury, death or substantial property damage if the warning included with this symbol is ignored.
- Take care to avoid contact with hot surface. Always use hand protection to avoid burns.
- For indoor and household use only.

SAVE THESE INSTRUCTIONS

NINJA

Foodi

SMART XL 2-BASKET AIR FRYER

804106932

Please read this manual carefully before operating your unit and retain for future reference.

TECHNICAL SPECIFICATIONS

Voltage: 120V~, 60Hz

Recipe Book Not Included

PARTS

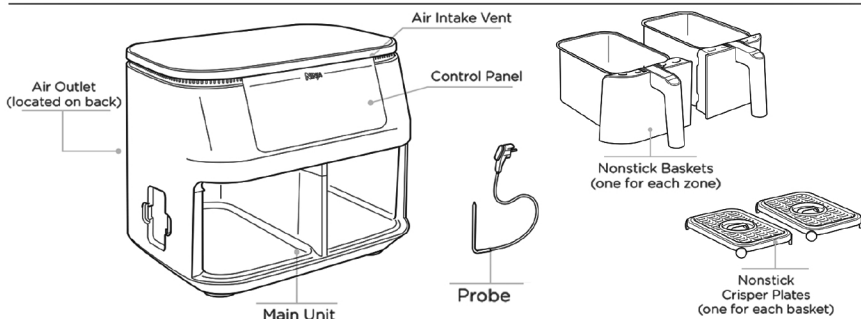

Accessories may vary depending on the model.

GETTING TO KNOW YOUR NINJA® FOODI® SMART XL 2-BASKET AIR FRYER

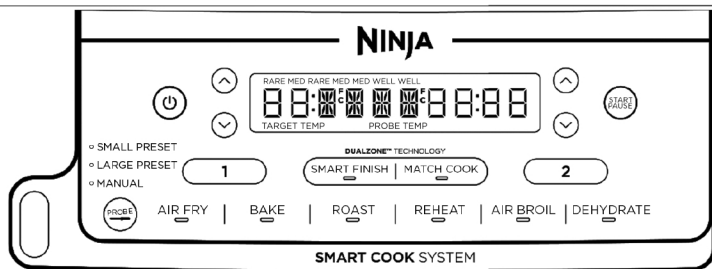

When setting time, the digital display shows HH:MM.

FUNCTIONS

AIR FRY: Use this function to give your food crispiness and crunch with little to no oil.

BAKE: Create decadent baked treats and desserts.

ROAST: Roast meats to tenderize and more.

AIR BROIL: Add the crispy finishing touch to meals, or melt toppings to create the perfect finish.

REHEAT: Warm your leftovers, with a crispy result.

DEHYDRATE: Dehydrate meats, fruits, and vegetables for healthy snacks.

OPERATING BUTTONS

- Zone 1 controls the output for the basket on the left.
- Zone 2 controls the output for the basket on the right.

LEFT arrows: Use the arrows on the left-hand side of the display to select the desired cook temperature or protein type.

TIME arrows: Use the arrows on the right-hand side of the display to select cook time or doneness.

BEFORE FIRST USE

- Remove and discard any packaging material.
- Remove all accessories from the package and read this manual carefully. Please pay particular attention to operational instructions, warnings, and important safeguards to avoid any injury or property damage.
- Wash the baskets and crisper plates in hot, soapy water, then rinse and dry thoroughly. The crisper plates and baskets are the **ONLY** dishwasher-safe parts. **NEVER** clean the main unit and Foodi Smart Thermometer in the dishwasher.

SMART FINISH button: Automatically syncs the cook times to ensure both zones finish at the same time, even if there are different cook times.

MATCH COOK button: Automatically matches Zone 2 settings to those of Zone 1 to cook a larger amount of the same food, or cook different foods using the same function, temperature, and time.

PROBE button: Use to select Small Preset, Large Preset, or Manual when using the Foodi® Smart Thermometer.

POWER button: The button turns the unit on and off and stops all cooking functions.

Standby Mode: After 10 minutes of no interaction with the control panel, the unit will enter standby mode. The Power button will be dimly lit.

Hold Mode: Hold will appear on the unit while in SMART FINISH mode. One zone will be cooking, while the other zone will be holding until the times sync together.

The actual descriptions of control panel and their locations may vary, depending on the model.

USING THE NINJA® FOODI® SMART THERMOMETER

Before plugging thermometer into the unit, make sure the jack is free of any residue, knots or kinks and the cord is free of knots.

NOTE: The Foodi Smart Thermometer is only available for use in Zone 1.

- Remove the thermometer storage compartment located on the left-hand side of the unit. Then unwind the cord from the compartment to remove the thermometer. Remove Zone 1 basket (before plugging in the thermometer).
- Insert the thermometer in protein using the guide on the following page to ensure the thermometer is placed correctly.
- Plug the thermometer into jack (located on the left-hand side of the control panel). Push firmly on the plug until it cannot go into the jack any further, and then insert the basket. You should hear and feel a click when the thermometer is inserted fully. Place the storage compartment back onto the side of the unit.

NOTE: The excess probe wire can be left in the basket.

- Once the thermometer is plugged into the jack, select Zone 1 and then desired cooking function. If desired, use the left-hand arrows to adjust cooking temperature.
- Use the PROBE button to select either Small or Large preset, depending on size of protein. Use the arrows on the left of the display to select your protein and the arrows on the right of the display to set the internal doneness of the protein. If using the Manual button, use the recommended internal cook temperatures below.

FOOD TYPE:	SET DONENESS TO:
Fish	Medium (130°F)
	Medium Well (140°F)
Chicken/Turkey	Well Done (150°F)
	Well Done (165°F)
Pork	Medium (130°F)
	Medium Well (150°F)
Beef	Well Done (160°F)
	Rare (115°F)
	Medium Rare (125°F)
	Medium (130°F)
	Medium Well (145°F)
	Well Done (150°F)

Using Match Cook with the Foodi Smart Thermometer:

- Press Zone 1 and select desired cooking function. Use the left-hand arrows to select desired cook temperature. Use the PROBE button to select Small Preset or Large Preset, depending on the size of the protein. Reference the Quick Start Guide for guidance. If using the Manual button, use the recommended internal cook temperatures.
- Use the arrows on the left of the display to select your desired protein and the arrows on the right of the display to set the internal doneness.
- Select MATCH COOK, then press the START/PAUSE button to begin cooking.

HOW TO CORRECTLY INSERT THE THERMOMETER

FOOD TYPE:	PLACEMENT	CORRECT	INCORRECT
Steaks Pork chops Chicken breasts Burgers Tenderloins Fish filets	<ul style="list-style-type: none">Insert thermometer horizontally into the center of the thickest part of the meat.Make sure the thermometer is close to (but not touching) the bone and away from any fat or gristle.Make sure the tip of the thermometer is inserted straight into the center of the meat, not angled toward the bottom or top of it.		
Whole chicken	<ul style="list-style-type: none">Insert thermometer horizontally into the thickest part of the breast, parallel to, but not touching, the bone.Make sure the tip reaches the center of the thickest part of the breast and doesn't go all the way through the breast into the cavity.		

NOTE: DO NOT use the thermometer with frozen protein or for cuts of meat thinner than 1 inch.

REFURBISHED PRODUCT LIMITED NINETY DAYS WARRANTY

The **Refurbished Product Service Center** offers the following WARRANTY to the ORIGINAL purchaser of a product which we have refurbished.

This product that has been refurbished is warranted against any electronic or mechanical defects for a period of NINETY DAYS from the date of the original purchase by the consumer. Since this unit was sold as a refurbished item, the warranty does not apply to any cosmetic appearance items such as scratches. Should a defect occur, the **Refurbished Product Service Center** will repair or, at its option, replace defective unit/parts with new or rebuilt materials without charge for either parts or labor. Replacement unit/parts will be warranted for the remaining portion of the original warranty period.

This warranty does not cover installation or damage from accident, misuse, abuse, improper wiring, incorrect voltage, operating the unit against the instructions in the owner's manual or any product which has been opened, altered, or tampered with.

This warranty does not cover costs for removal and or installation of the unit for repair. Under no circumstances shall the service center be liable for any special, incidental or consequential damages or for any other expenses incurred by reason of use or sale of this product. This warranty is in lieu of any other warranties expressed or implied warranty of merchantability of fitness for particular use or otherwise.

This warranty gives the consumer specific legal rights and they may also have other rights which vary from State to State. Some States do not follow the exclusion or limitation of incidental or consequential damages, hence the above exclusion and limitations may not apply.

Refurbished Product Service Center
13225 Marquardt Avenue Santa Fe Springs, CA 90670.

WARRANTY REPAIR INFORMATION

If you need service on your unit and this product requires repair during the 90 days warranty period, please go to www.ConsumerServiceRefurbish.com or call the **Refurbished Product Service Center** at 562-946-3531 to obtain the required return authorization (RA) number. Pack the unit properly (the original carton is ideal for this purpose) along with a copy of your purchase receipt and a letter describing the problem. Send the unit freight prepaid and insured to:

Refurbished Product Service Center,
Att: Customer Service Department 13225
Marquardt Avenue Santa Fe Springs, CA
90670

Your unit will be promptly repaired and returned to you. We will refuse to accept delivery of the returned unit unless the assigned RA number appears on the outside of the shipping carton.

Owner's Information
(Keep for your permanent records)

NAME: _____
ADDRESS: _____
CITY: _____
STATE: _____
ZIP CODE: _____
PHONE: _____
E-MAIL: _____
MODEL: _____
SERIAL NO.: _____

COOKING IN YOUR 2-BASKET AIR FRYER

REFERENCE QUICK START GUIDE FOR RECIPES AND COOKING CHARTS

COOKING WITH DUALZONE™ TECHNOLOGY

DualZone Technology utilizes two cooking zones to increase versatility. The Smart Finish feature ensures that, regardless of different cook settings, both zones will finish ready to serve at the same time.

SMART FINISH (without Foodi® Smart Thermometer)

To finish cooking at the same time when foods have different cook times, temps, or even functions:

- Place ingredients in the baskets, insert the baskets in the unit and then press the power button.
- Zone 1 will remain illuminated. Select the desired cook function. Use the left arrows to set the temperature, and use the right arrows to set the time.



- Select Zone 2, then select the desired cook function (Air Broil can be used in only one zone when using Smart Finish). Use the left arrows to set the temperature, and use the right arrows to set the time.
- Press SMART FINISH, then press the START/PAUSE button to begin cooking in the zone with the longest time. The other zone will display **Hold**. The unit will beep and activate the second zone when both zones have the same time remaining.



NOTE: Air Broil can only be used in one zone at a time.

NOTE: When using Air Broil, you can select a different function for Zone 2.



NOTE: It is recommended to shake your food during cooking. To keep the time at a synchronized finish, press the START/PAUSE button to pause both zones. To pause a single zone during dual zone cooking.

- When cooking is complete, the unit will beep and "End" will appear on the display.

- Remove ingredients by dumping them out or using silicone-tipped tongs/utensils. **DO NOT** place drawer on top of unit.

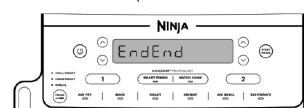

NOTE: If you decide the food in one of the zones is done cooking before the cook time is up, you can **STOP A ZONE**. Select that zone, then press the START/PAUSE button to pause the zone or set the time to zero.

MATCH COOK (without Foodi Smart Thermometer)

To cook a larger amount of the same food, or cook different foods using the same function, temperature, and time:

- Place ingredients in the baskets, insert the baskets in the unit, and then press the power button.
- Zone 1 will remain illuminated. Select the desired cook function (Air Broil is not available for use in either zone when using Match Cook). Use the left arrows to set the temperature, and use the right arrows to set the time.



- Press the MATCH COOK button to copy the Zone 1 settings to Zone 2. Then press the START/PAUSE button to begin cooking in both zones.



NOTE: Air Broil cannot be used in Match Cook mode.

NOTE: It is recommended to shake your food during cooking. To keep the time at a synchronized finish, press the START/PAUSE button to pause both zones. To pause a single zone during dual zone cooking.

- "End" will appear on both screens when cooking ends at the same time.

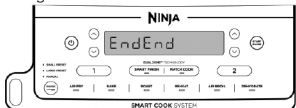

- Remove ingredients by dumping them out or using silicone-tipped tongs/utensils.

COOKING WITH TWO ZONES

When Smart Finish or Match Cook are not selected, technology is integrated into the design to automatically optimize the distribution of power when using two zones

with different cook times. This means the food in the zone with the longer cook time may finish cooking before the set time ends. Check food frequently to avoid overcooking.

- Select Zone 1, then select the desired cook function. Use the left arrows to set the temperature.



- Use the right arrows to set the time.



- Repeat steps 2 and 3 for Zone 2.



- Press the START/PAUSE button to begin cooking in both zones.



- When cooking is complete in the zone with the shorter cook time, the power will then shift to help optimize cook time in the remaining zone.

- Continue to monitor food, as it may finish cooking before the set cook time ends.

- Remove ingredients by dumping them out or using silicone-tipped tongs/utensils.

COOKING IN A SINGLE ZONE

To turn on the unit, plug the power cord into a wall outlet, then press the power button.

Air Fry

- Install crisper plate in the basket, then place ingredients in the basket, and insert basket in unit.

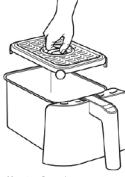

- The unit will default to Zone 1 (to use Zone 2 instead, select Zone 2). Select AIR FRY.



- Use the left arrows to set the desired temperature.



- Use the right arrows to set the time in 1-minute increments. Press the START/PAUSE button to begin cooking.



NOTE: During cooking, you can remove the basket and shake or toss ingredients for evening crisping. If you would like to pause during this time, press the zone number then press the START/PAUSE button. If using a single zone, simply press the START/PAUSE button.

- When cooking is complete, the unit will beep and "End" will appear on the display.

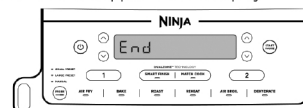

- Remove ingredients by dumping them out or using silicone-tipped tongs/utensils.

Bake

- Install crisper plate in the basket (optional), then place ingredients in the basket, and insert basket in unit.



- The unit will default to Zone 1 (to use Zone 2 instead, select Zone 2). Select BAKE.



NOTE: To convert recipes from a traditional oven, reduce the temperature by 25°F.

- Use the left arrows to set the desired temperature.



- Use the TIME arrows to set the time in 1-minute increments up to 1 hour and in 5-minute increments from 1 to 4 hours. Press the START/PAUSE button to begin cooking.



- When cooking is complete, the unit will beep and "End" will appear on the display.

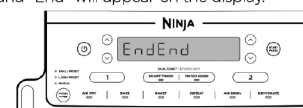

- Remove ingredients by dumping them out or using silicone-tipped tongs/utensils.

Roast

- Install crisper plate in the basket (optional), then place ingredients in the basket, and insert basket in unit.



- The unit will default to Zone 1 (to use Zone 2 instead, select Zone 2). Select ROAST.



- Use the left arrows to set the desired temperature.



- Use the right arrows to set the time in 1-minute increments up to 1 hour and in 5-minute increments from 1 to 4 hours. Press the START/PAUSE button to begin cooking.



- When cooking is complete, the unit will beep and "End" will appear on the display.



- Remove ingredients by dumping them out or using silicone-tipped tongs/utensils.

Air Broil (Not available on all models.)

NOTE: AIR BROIL cannot be used in both zones at the same time.

- Install crisper plate in the basket, then place ingredients in the basket, and insert basket in unit.



- The unit will default to Zone 1 (to use Zone 2 instead, select Zone 2). Select AIR BROIL.

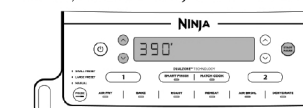

- Use the left arrows to set the desired temperature.



- Use the right arrows to set the time in 1-minute increments up to 30 minutes. Press the START/PAUSE button to begin cooking.



- When cooking is complete, the unit will beep and "End" will appear on the display.

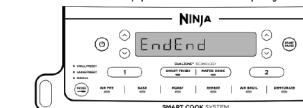

- Remove ingredients by dumping them out or using silicone-tipped tongs/utensils.

Reheat

- Install crisper plate in the basket (optional), then place ingredients in the basket, and insert basket in unit.

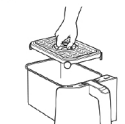

- The unit will default to Zone 1 (to use Zone 2 instead, select Zone 2). Select REHEAT.

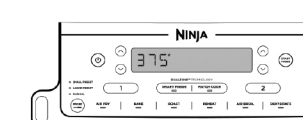

- Use the left arrows to set the desired temperature.



- Use the right arrows to set the time in 1-minute increments up to 1 hour. Press the START/PAUSE button to begin reheating.



- When reheating is complete, the unit will beep and "End" will appear on the display.

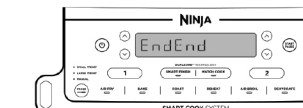

- Remove ingredients by dumping them out or using silicone-tipped tongs/utensils.

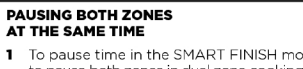

PAUSING BOTH ZONES AT THE SAME TIME

- To pause time in the SMART FINISH mode, or to pause both zones in dual zone cooking, press the START/PAUSE button.



PAUSING A SINGLE ZONE DURING DUAL ZONE COOKING

- To pause time in a single zone while both zones are running, select the zone you want to pause, then press the START/PAUSE button.

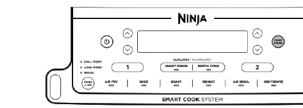

- To resume cooking, press the button again.

NOTE: This is not available when using Smart Finish and the Foodi Smart Thermometer.

CLEANING YOUR 2-BASKET AIR FRYER

The unit should be cleaned thoroughly after every use. Unplug the unit from the wall outlet before cleaning.

Part/Accessory	Cleaning Method	Dishwasher Safe?
Main Unit	To clean the main unit and the control panel, wipe them clean with a damp cloth. NOTE: NEVER immerse the main unit in water or any other liquid. NEVER clean the main unit in a dishwasher.	No
Crisper Plates	The crisper plates can be washed in the dishwasher or by hand. If hand-washing, air-dry or towel-dry all parts after use.	Yes
Baskets	The baskets can be washed in the dishwasher or by hand. If hand-washing, air-dry or towel-dry all parts after use. *To extend the life of your basket, we recommend hand-washing them.	Yes*
Foodi Smart Thermometer	Do not place the thermometer in the dishwasher or immerse it in water or any other liquid. Wipe clean with a damp cloth.	No

If food residue is stuck on the crisper plates or baskets, place them in a sink filled with warm, soapy water and allow to soak.

804106932 PRINTED IN MEXICO Elbrd: A.M. OBPN: DZ550Series_IB_MP_Mv9_220414 SC: 01-12-2023_TAB MODEL: DZ550

Dehydrate

- Place a single layer of ingredients in the basket. Then install the crisper plate in the basket on top of the ingredients and place another layer of ingredients on the crisper plate.

- The unit will default to Zone 1 (to use Zone 2 instead, select Zone 2). Select DEHYDRATE. The default temperature will appear on the display. Use the left arrows to set the desired temperature.



- Use the right arrows to set the time in 15-minute increments from 1 to 12 hours. Press the START/PAUSE button to begin dehydrating.

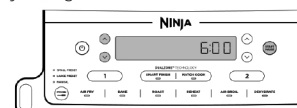

- When cooking is complete, the unit will beep and "End" will appear on the display.

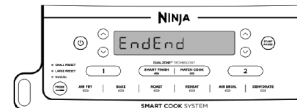

- Remove ingredients by dumping them out or using silicone-tipped tongs/utensils.

ENDING THE COOK TIME IN ONE ZONE (WHILE USING BOTH ZONES)

- Select the zone you would like to stop.



- Then press the down TIME arrow to set the time to zero.



- Once you have set the time to zero, press the START/PAUSE button.

- The time in that zone is then canceled, and "End" will appear on the display. Cooking will continue in the other zone.



NOTE: This is not available when using Smart Finish and the Foodi Smart Thermometer.

HELPFUL TIPS

- For consistent browning, make sure ingredients are arranged in an even layer on the bottom of the basket with no overlapping. If ingredients are overlapping, make sure to shake them halfway through cooking.
- To convert recipes from a traditional oven, reduce the temperature by 25°F. Check food frequently to avoid overcooking.
- Occasionally, the fan from the air fryer will blow lightweight foods around. To alleviate this, secure foods (like the top slice of bread on a sandwich) with wooden toothpicks.
- The crisper plates elevate ingredients in the baskets so air can circulate under and around ingredients for even, crisp results.
- After selecting a cooking function, you can press the START/PAUSE button to begin cooking immediately. The unit will run at the default temperature and time.
- For best results with fresh vegetables and potatoes, use at least 1 tablespoon of oil. Add more oil as desired to achieve the preferred level of crispiness.
- For best results, check progress throughout cooking and remove food when desired level of brownness has been achieved. We recommend using an instant-read thermometer to monitor the internal temperature of proteins.

TROUBLESHOOTING GUIDE

- How do I adjust the temperature or time while using a single zone?**
When a single zone is running the time or temperature can be adjusted at any time by pressing the up/down arrows.
- How do I adjust the temperature or time while using both zones?**
Select the desired zone, then use the TEMP arrows to adjust the temperature or the TIME arrows to adjust the time.
- Can I cook different foods in each zone and not worry about cross contamination?**
Yes, both zones are self-contained with separate heating elements and fans.
- How do I pause or stop one zone when using both zones?**
Select the zone you want to pause or stop, then press the START/PAUSE button.
- Are the baskets safe to put on my countertop?**
The baskets will heat up during cooking. Use caution when handling, and place them on heat-safe surfaces only. **DO NOT** place the baskets on the top of the unit.
- When should I use the crisper plate?**
Use the crisper plate when you want food to come out crispy. The plate elevates the food in the basket so that air can flow under and around it to cook ingredients evenly.
- Why didn't my food cook fully?**
Make sure the basket is fully inserted during cooking. For consistent browning, make sure ingredients are arranged in an even layer on the bottom of the basket with no overlapping. Shake basket to toss ingredients for even crispiness. Cook temperature and time can be adjusted at any time during cooking. Simply use the TEMP arrows to adjust the temperature or the TIME arrows to adjust the time.
- Why is my food burned?**
For best results, check progress throughout cooking and remove food when desired level of brownness has been achieved. Remove food immediately after the cook time ends to avoid overcooking.
- Why do some ingredients blow around when air frying?**
Occasionally, the fan from the air fryer will blow lightweight foods around. Use wooden toothpicks to secure loose lightweight food, like the top slice of bread on a sandwich.
- Can I air fry wet, battered ingredients?**
Yes, but use the proper breading technique. It is important to coat foods first with flour, then with egg, and then with bread crumbs. Press breading firmly onto the battered ingredients, so crumbs won't be blown off by the fan.
- Why did the display screen go black?**
The unit is in standby mode. Press the power button to turn it back on.
- Why is the unit beeping?**
Either the food is done cooking, or the other zone has started cooking.
- Why is there an "E" message on the display screen?**
The unit is not functioning properly. Please contact a Service Center.
- Why did a circuit breaker trip while using the unit?**
The unit uses 1690 watts of power, so it must be plugged into an outlet on a 15-amp circuit breaker. Using an outlet on a 10-amp breaker will cause the breaker to trip. It is also important that the unit be the only appliance plugged into an outlet when in use. To avoid tripping a breaker, make sure the unit is the only appliance plugged into an outlet on a 15-amp breaker.