

LIFT-AWAY ADV

Upright Vacuum with PowerFins[™] and Self-Cleaning Brushroll

POWERFINS

804106079

IMPORTANT SAFETY INSTRUCTIONS

HOUSEHOLD USE ONLY

To reduce the risk of electric shock, this vacuum cleaner has a polarized plug (one blade is wider than the other). As a safety feature, this plug will fit into a polarized outlet only one way. If the plug does not fit fully into the outlet, reverse the plug. If it still does not fit, contact a qualified electrician. **DO NOT** force into outlet or try to modify to fit.

⚠ WARNING

TO REDUCE THE RISK OF FIRE, ELECTRIC SHOCK OR INJURY:

GENERAL WARNINGS

When using an electrical appliance, basic precautions should always be followed, including the following:

1. Inspect power cord and plug for any damage before use. **DO NOT** use vacuum cleaner with a damaged cord or plug. Turn off all controls before plugging in or unplugging the vacuum cleaner. Store your vacuum cleaner with the power cord secured around the two cord hooks. To minimize the risk of power cord damage, do not allow the motorized brush roll to ingest the cord. If this occurs, immediately shut off power to the vacuum and remove the cord.
2. Your vacuum cleaner may consist of a motorized nozzle, wand, hose, and/or vacuum pod. This device contains electrical connections, electrical wiring, and moving parts that potentially present risk to the user.
3. Use only identical replacement parts.
4. Carefully observe and follow the instructions provided below to avoid improper use of the appliance. **DO NOT** use the vacuum for any purpose other than those described in this manual.
5. Before use, carefully inspect all parts for any damage. **DO NOT** use if any parts are damaged.
6. The use of an extension cord is **NOT** recommended.
7. This vacuum cleaner contains no serviceable parts.

USE WARNINGS

8. This appliance can be used by persons with reduced physical, sensory or mental capabilities or lack of experience and knowledge if they have been given supervision or instruction concerning use of the appliance in a safe way and understand the hazards involved. Cleaning and user maintenance shall not be made by children. Keep the appliance and its cord out of reach of children. **DO NOT** allow the appliance to be used by children. **DO NOT** allow to be used as a toy. Close supervision is necessary when used near children.
9. Always turn off the vacuum cleaner before connecting or disconnecting any motorized nozzles or other accessories.
10. **DO NOT** handle plug or vacuum cleaner with wet hands.
11. **DO NOT** use without filters in place.
12. Only use Shark[®] branded filters and accessories.
13. **DO NOT** damage the power cord:
 - a) **DO NOT** pull or carry vacuum cleaner by the cord or use the cord as a handle.
 - b) **DO NOT** unplug by pulling on cord. Grasp the plug, not the cord.
 - c) **DO NOT** run the vacuum cleaner over the power cord, close a door on the cord, pull the cord around sharp corners, or leave the cord near heated surfaces.
14. **DO NOT** put any objects into nozzle or accessory openings. **DO NOT** use with any opening blocked; keep free of dust, lint, hair, and anything that may reduce airflow.
15. **DO NOT** use if nozzle or accessory airflow is restricted. If the air paths or the motorized floor nozzle become blocked, turn the vacuum cleaner off and unplug from electrical outlet. Remove all obstructions before you plug in and turn on the unit again.
16. Keep nozzle and all vacuum openings away from hair, face, fingers, uncovered feet, or loose clothing.
17. **DO NOT** use if vacuum cleaner is not working as it should, or has been dropped, damaged, left outdoors, or dropped into water.
18. Use extra care when cleaning on stairs.
19. **DO NOT** leave the vacuum cleaner unattended while plugged in.
20. When powered on, keep the vacuum cleaner moving over the carpet surface at all times to avoid damaging the carpet fibers.
21. **DO NOT** place vacuum cleaner on unstable surfaces such as chairs or tables.
22. Your Shark[®] vacuum may not be designed to stand up on its own. When taking a break from cleaning, you may need to lean it against furniture or a wall, or lay it flat on the floor. Using the vacuum for an application where the unit lacks stability may result in personal injury.
23. **DO NOT** use to pick up:
 - a) Liquids
 - b) Large objects
 - c) Hard or sharp objects (glass, nails, screws, or coins)
 - d) Large quantities of dust (drywall dust, fireplace ash, or embers). **DO NOT** use as an attachment to power tools for dust collection.
 - e) Smoking or burning objects (hot coals, cigarette butts, or matches)

- f) Flammable or combustible materials (lighter fluid, gasoline, or kerosene)
 - g) Toxic materials (chlorine bleach, ammonia, or drain cleaner)
24. **DO NOT** use in the following areas:
 - a) Poorly lit areas
 - b) Wet or damp surfaces
 - c) Outdoor areas
 - d) Spaces that are enclosed and may contain explosive or toxic fumes or vapors (lighter fluid, gasoline, kerosene, paint, paint thinners, mothproofing substances, or flammable dust)
 25. Turn off all controls before plugging in or unplugging the vacuum.
 26. Unplug from electrical outlet when not in use and before any maintenance or cleaning.
 27. Hand wash with water only. Washing with cleaning chemicals could damage the unit.
 28. During cleaning or routine maintenance, **DO NOT** cut anything other than hair, fibers, or string wrapped around the brushroll.
 29. Allow all filters to air-dry completely before replacing in the vacuum to prevent liquid from being drawn into electric parts.
 30. Make sure the dust cup and all filters are in place after routine maintenance.
 31. If provided, secure the power cord around the two cord hooks during storage.

TECHNICAL SPECIFICATIONS

Voltage: 120V~, 60Hz

ASSEMBLY

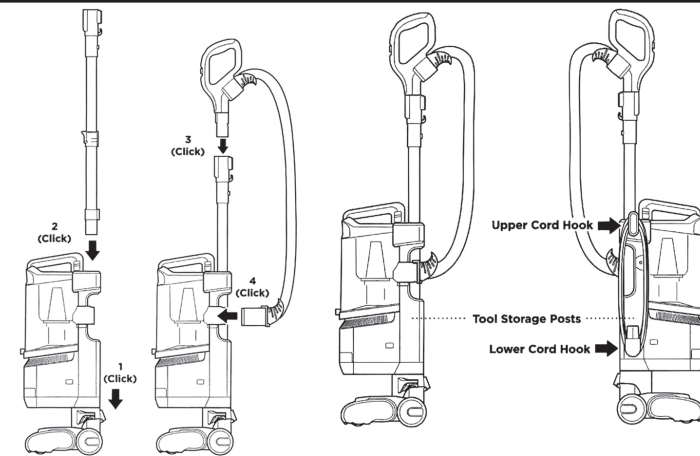

1. Slide **Vacuum Pod** down onto **Floor Nozzle Post**.
2. Insert **Wand** into **Vacuum Pod**.
3. Insert **Handle** into wand.
4. Attach **Hose** to back of pod.

For proper operation, ensure all parts are firmly clicked into place.

Note: Your Quick Start Guide shows the accessories that are included with your model.

*Accessories may vary depending on model.

The image shown here is for illustrative purposes only and may be subject to change.

POWER CORD

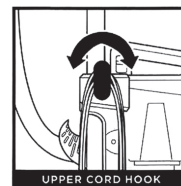

For cord access, rotate upper hook down and remove cord.

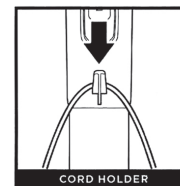

Use cord holder on the side of wand to hold cord in place while vacuuming.

WHOLE-HOME CLEANING

SETTINGS

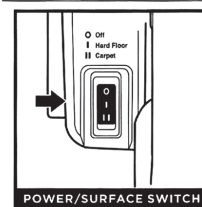

Select surface setting:
Off
I Hard Floor
 For hard floors and small area rugs.
II Carpet
 For carpets.

NOTE: Brushroll spins in all modes.

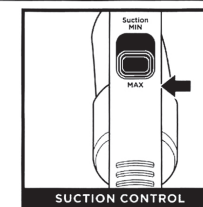

The **Suction Control Slider** located on the handle allows you to adjust the suction depending on the floor type.
MIN: to reduce suction and increase maneuverability on carpets.
MAX: to increase suction on hard floors.

BRUSHROLL INDICATOR LIGHT

WHAT DOES THE BRUSHROLL INDICATOR LIGHT MEAN?

- Solid Green:** The brushroll is spinning and working as intended.
- Solid Red:** There is a jam in the brushroll area. Turn off and unplug the vacuum and remove any blockages in the nozzle.
- Flashing Red:** The motorized floor nozzle is overheating. Turn off the vacuum, unplug it, and remove any blockages. Let the vacuum cool down for at least 60 minutes before restarting. See Troubleshooting section for more information.

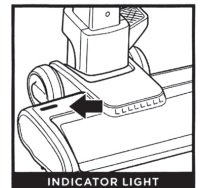

NOTE: For deep carpet cleaning per ASTM F608 (embedded dirt in carpets) set to MAX suction and use setting II. Carpet

CLEANING MODES

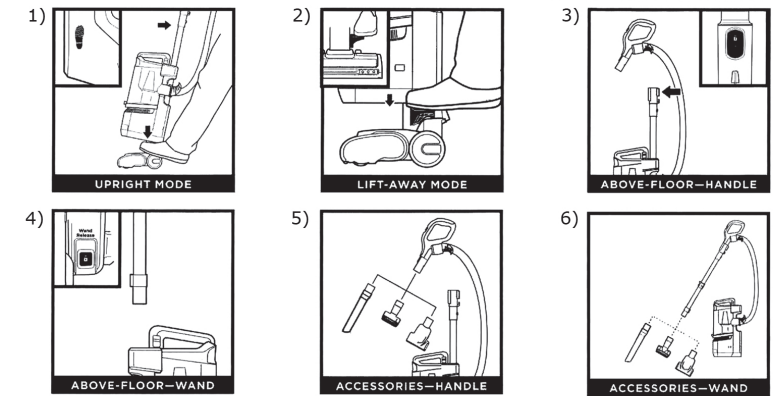

*Accessories may vary depending on model.

1. To engage **Brushroll**, turn power on, select a surface setting, then step on floor nozzle and tilt handle back.
2. Step on the pedal on the floor nozzle to lift off the pod. When finished cleaning in Lift-Away mode, reattach the pod by sliding it onto the floor nozzle post until it clicks into place.
3. Press the **Handle Release** button and pull up on the handle to detach it from the wand.
4. Press the **Wand Release** button and pull up on the wand to detach it from the pod.
5. Attach an optional cleaning accessory to handle or wand.

NOTE: All accessories are compatible with both the wand and the handle. Included accessories will vary by model.

EMPTYING THE DUST CUP



IMPORTANT: Unplug the power cord before performing any maintenance. Empty the dust cup each time you vacuum and periodically during cleaning, when debris in the dust cup reaches the MAX fill line.

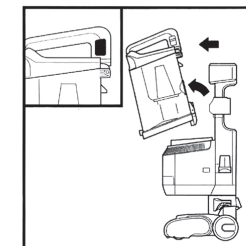

To remove **Dust Cup**, pull up on the release button located on the side of dust cup handle. Tilt dust cup forward, then lift to remove.



Hold the dust cup over the waste bin and press the release button to open bottom of dust cup.

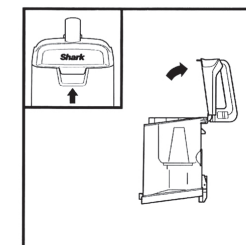

To remove collected debris from **Lint Screen**, lift the tab at the top of the dust cup to open the lid. Remove debris from lint screen to clean.

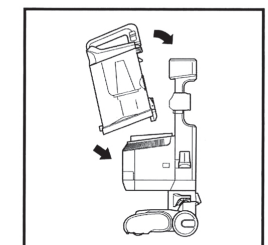

To reinstall, place the bottom of the dust cup onto the pod and then tilt until it clicks into place.

CLEANING THE FILTERS

Regularly rinse the filters to maintain your vacuum's suction power.

Rinse filters with cold water only. Allow all filters to air-dry for at least 24 hours before reinstalling them to prevent liquid from being drawn into electronic parts.

IMPORTANT: DO NOT use soap when cleaning the filters.

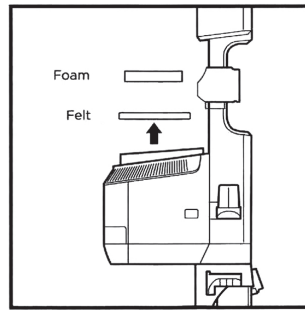

RINSE PRE-MOTOR FILTERS EVERY MONTH

Remove **Dust Cup**, then lift out **Filters**.

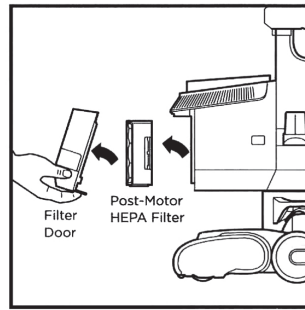

RINSE HEPA FILTER EVERY YEAR

To remove the **HEPA Filter**, first pull the tab on the bottom of the filter door, then lift off the door. Press the tab on the left side of the HEPA filter and pull out the filter.

To reinstall the HEPA filter, insert the right side of the filter first. Push in the tab on the left side of the HEPA filter until it clicks into place. To reinstall the door, align the top first, then press in the bottom until it clicks into place.

NOTE: The pre-motor filters should be replaced every 2.5 years. The post-motor filter should be replaced every 3 years.

MAINTENANCE

NOZZLE MAINTENANCE

SELF-CLEANING BRUSHROLL

If any hair is wrapped around the brushroll, continue vacuuming, using Carpet/Low Pile mode on a bare floor surface, a low-pile carpet, or a small area rug. This will allow the self-cleaning brushroll to remove the hair wrap and send it to the dust cup.

If you run over a hard or sharp object or notice a noise change while vacuuming, check for blockages or objects caught in the brushroll.

If some fibers remain wrapped around the brushroll after continued use, clear them from the brushroll.

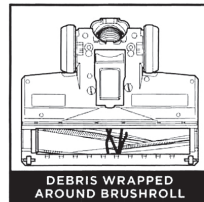

DEBRIS WRAPPED AROUND BRUSHROLL

Clean off any debris on the brushroll.

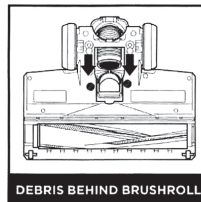

DEBRIS BEHIND BRUSHROLL

To access the bottom of the nozzle for any blockages, open the locks on the bottom of the nozzle. With a coin, turn the locks counterclockwise to open, then lift the cover.

CORD MAINTENANCE

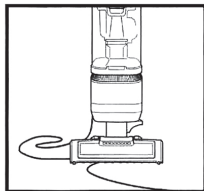

To minimize the risk of power cord damage, **DO NOT** run the vacuum over the power cord. If this occurs, immediately shut off power to the vacuum and remove the cord from the brushroll or nozzle.

- DO NOT** pull or carry vacuum cleaner by the cord or use cord as a handle.
- DO NOT** unplug by pulling on the cord. Grasp the plug, not the cord.
- DO NOT** close the door on the cord.
- DO NOT** pull the cord around sharp corners.
- DO NOT** leave the cord near heated surfaces.

* Your Quick Start Guide shows the accessories that are included with your model.

NOTE: Accessories may vary depending on the model. Refer to quick guide, if available.

The images shown here are for illustrative purposes only and may be subject to change.

CHECKING FOR BLOCKAGES

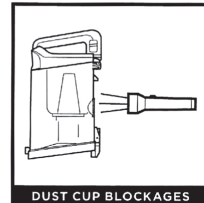

DUST CUP BLOCKAGES

Detach dust cup from vacuum pod. Empty dust cup and remove debris from lint screen in the top of the dust cup.

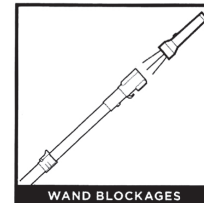

WAND BLOCKAGES

Detach wand from pod and handle, and check both ends for blockages.

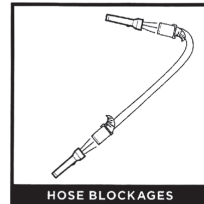

HOSE BLOCKAGES

Detach hose from handle by pressing on the release button at the top of the hose. Detach the hose from the pod, and check openings for blockages.

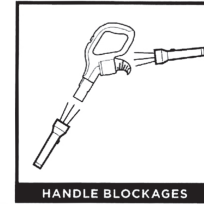

HANDLE BLOCKAGES

Detach handle from wand and hose to check the openings on both ends.

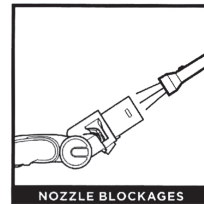

NOZZLE BLOCKAGES

Check the opening at the top of the nozzle for any blockages.

TROUBLESHOOTING

Power cord caught in brushroll or floor nozzle.

- To minimize the risk of power cord damage, **DO NOT** run the vacuum over the power cord. If this occurs, immediately shut off power to the vacuum and remove the cord from the brushroll or nozzle.

- Inspect power cord and plug for any damage before use. **DO NOT** use vacuum cleaner with a damaged cord or plug. Turn off all controls before plugging in or unplugging the vacuum cleaner. Store your vacuum cleaner with the power cord secured around the two cord hooks.

Vacuum is not picking up debris. No suction or light suction.

- Check filters to see if they need cleaning. Follow instructions for rinsing and air-drying the filters before reinstalling them in the vacuum.
- Dust cup may be full; empty dust cup.
- Check handle, hose, hose connections, nozzle, wand, pod, and accessories for blockages. Clear any blockages found.
- If any string, hair, or carpet fibers are wrapped around the brushroll remove from brushroll. See Nozzle Maintenance section for more information.

Vacuum lifts area rugs.

- Make sure Power/Surface switch is set to Hard Floor (setting I).
- Ensure the suction control slider on the handle is set to MIN.
- Suction is powerful. Take care when vacuuming area rugs or rugs with delicately sewn edges.

Brushroll does not spin.

- If the Brushroll Indicator Light turns red, immediately turn off and unplug the vacuum. Remove pod from floor nozzle and clear any blockages. Reconnect nozzle, plug in vacuum, and turn on power.
- With the power on, recline the handle, which will automatically turn on the brushroll.
- If this problem persists on thick carpets, move the suction control slider to MIN.

Vacuum turns off on its own or indicator light flashes red.

If your vacuum overheats, the thermostat will automatically turn the suction motor off. Perform the following steps to restart the thermostat:

- Turn vacuum off and unplug it.
- Empty dust cup and clean filters (see Emptying the Dust Cup and Cleaning the Filters).
- Check for blockages in hose, nozzle, accessories, and inlet openings.
- Allow unit to cool for a minimum of 60 minutes.
- Plug in vacuum and restart with the Power/Surface switch.

PLEASE READ CAREFULLY AND KEEP FOR FUTURE REFERENCE.

This Owner's Guide is designed to help you get a complete understanding of your new Shark Navigator® Lift-Away® ADV Upright Vacuum with PowerFins™ and Self-Cleaning Brushroll.

Illustrations may differ from actual product. We are constantly striving to improve our products; therefore the specifications contained herein are subject to change without notice.

For SharkNinja U.S. Patent information, visit sharkninja.com/uspatents

© 2021 SharkNinja Operating LLC. LIFT-AWAY, SHARK, and SHARK NAVIGATOR are registered trademarks of SharkNinja Operating LLC. NAVIGATOR and POWERFINS are trademarks of SharkNinja Operating LLC.

REFURBISHED PRODUCT LIMITED NINETY DAYS WARRANTY

The **Refurbished Product Service Center** offers the following WARRANTY to the ORIGINAL purchaser of a product which we have refurbished.

This product that has been refurbished is warranted against any electronic or mechanical defects for a period of NINETY DAYS from the date of the original purchase by the consumer. Since this unit was sold as a refurbished item, the warranty does not apply to any cosmetic appearance items such as scratches. Should a defect occur, the **Refurbished Product Service Center** will repair or, at its option, replace defective unit/parts with new or rebuilt materials without charge for either parts or labor. Replacement unit/parts will be warranted for the remaining portion of the original warranty period.

This warranty does not cover installation or damage from accident, misuse, abuse, improper wiring, incorrect voltage, operating the unit against the instructions in the owner's manual or any product which has been opened, altered, or tampered with.

This warranty does not cover costs for removal and or installation of the unit for repair. Under no circumstances shall the service center be liable for any special, incidental or consequential damages or for any other expenses incurred by reason of use or sale of this product. This warranty is in lieu of any other warranties expressed or implied warranty of merchantability of fitness for particular use or otherwise.

This warranty gives the consumer specific legal rights and they may also have other rights which vary from State to State. Some States do not follow the exclusion or limitation of incidental or consequential damages, hence the above exclusion and limitations may not apply.

Refurbished Product Service Center
13225 Marquardt Avenue Santa Fe Springs, CA 90670.

WARRANTY REPAIR INFORMATION

If you need service on your unit and this product requires repair during the 90 days warranty period; please go to www.ConsumerServiceRefurbish.com or call the **Refurbished Product Service Center** at 562-946-3531 to obtain the required return authorization (RA) number. Pack the unit properly (the original carton is ideal for this purpose) along with a copy of your purchase receipt and a letter describing the problem. Send the unit freight prepaid and insured to:

Refurbished Product Service Center,
Att: Customer Service Department 13225 Marquardt Avenue Santa Fe Springs, CA 90670

Your unit will be promptly repaired and returned to you. We will refuse to accept delivery of the returned unit unless the assigned RA number appears on the outside of the shipping carton.

Owner's Information (Keep for your permanent records)

NAME: _____

ADDRESS: _____

CITY: _____ STATE: _____ ZIP CODE: _____

PHONE: _____ E-MAIL: _____

MODEL: _____ SERIAL NO.: _____

PRINTED IN MEXICO Elbrd: J.E.
OBPN: LA400Series_IB_Mv6_210305
SC: 09-11-2021_TAB MODEL: QU400Q_B
ADD: LA401



Please be sure to read the enclosed Shark® Owner's Guide prior to using your unit.

QUICK START GUIDE

WHAT'S INSIDE

- (A) Handle & Hose
- (B) Wand
- (C) Vacuum Pod
- (D) Floor Nozzle
- (E) Pet Crevice Tool
- (F) Upholstery Tool



HELPFUL TIPS

Wash & replace filters regularly to keep the suction strong.

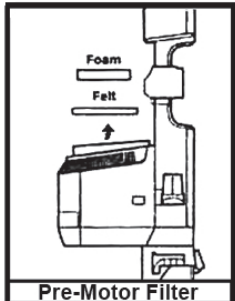

Pre-Motor Filter



HEPA FILTER

To minimize the risk of power cord damage, **DO NOT** run the vacuum over the power cord. If this occurs, immediately shut off power to the vacuum and remove the cord from the brushroll or nozzle.



ASSEMBLY

1. Insert **Wand** into **Vacuum Pod**. For proper operation, ensure all parts are firmly clicked into place.
2. Insert **Handle** into wand.
3. Attach **Hose** To back of vacuum pod.

Accessory type and quantity may vary depending on the model.

NOTE: The images shown here are for illustrative purpose only and may vary.

