

Please read this manual carefully before operating your unit and retain for future reference.







804106852

Before Reading This User Manual

This TV comes with this User Manual and an embedded e-Manual (Ⓜ) > ≡ Menu > ⚙ Settings > Support > Open e-Manual).

Warning! Important Safety Instructions

Please read the Safety Instructions before using your TV. Refer to the table below for an explanation of symbols which may be on your Samsung product.

CAUTION	
RISK OF ELECTRIC SHOCK. DO NOT OPEN.	
CAUTION: TO REDUCE THE RISK OF ELECTRIC SHOCK, DO NOT REMOVE COVER (OR BACK). THERE ARE NO USER SERVICEABLE PARTS INSIDE. REFER ALL SERVICING TO QUALIFIED PERSONNEL.	
	This symbol indicates that high voltage is present inside. It is dangerous to make any kind of contact with any internal part of this product.
	This symbol indicates that this product has included important literature concerning operation and maintenance.
	Class II product: This symbol indicates that a safety connection to electrical earth (ground) is not required. If this symbol is not present on a product with a power cord, the product MUST have a reliable connection to protective earth (ground).
	AC voltage: Rated voltage marked with this symbol is AC voltage.
	DC voltage: Rated voltage marked with this symbol is DC voltage.
	Caution. Consult instructions for use: This symbol instructs the user to consult the user manual for further safety related information.

Power

- Do not overload wall outlets, extension cords, or adaptors beyond their voltage and capacity. It may cause fire or electric shock. Refer to the power specifications section of the manual and/or the power supply label on the product for voltage and amperage information.
- Power-supply cords should be placed so that they are not likely to be walked on or pinched by items placed upon or against them. Pay particular attention to cords at the plug end, at wall outlets, and at the point where they exit from the appliance.
- Never insert anything metallic into the open parts of this apparatus. This may cause electric shock.
- To avoid electric shock, never touch the inside of this apparatus. Only a qualified technician should open this apparatus.
- Be sure to plug in the power cord until it is firmly seated. When unplugging the power cord from a wall outlet, always pull on the power cord's plug. Never unplug it by pulling on the power cord. Do not touch the power cord with wet hands.
- If this apparatus does not operate normally - in particular, if there are any unusual sounds or smells coming from it - unplug it immediately and contact a service center.
- To protect this apparatus from a lightning storm, or to leave it unattended and unused for a long time (especially when a kid, the elderly, or the disabled is left alone), be sure to unplug it from the wall outlet and disconnect the antenna or cable system.
 - Accumulated dust can cause an electric shock, an electric leakage, or a fire by causing the power cord to generate sparks and heat or by causing the insulation to deteriorate.
- Use only a properly grounded plug and wall outlet.
 - An improper ground may cause electric shock or equipment damage. (Class I Equipment only.)
- To turn off this apparatus completely, disconnect it from the wall outlet. To ensure you can unplug this apparatus quickly if necessary, make sure that the wall outlet and power plug are readily accessible.

Installation

- Do not place this apparatus near or over a radiator or heat register, or where it is exposed to direct sunlight.
- Do not place vessels (vases etc.) containing water on this apparatus, as this can result in a fire or electric shock.
- Do not expose this apparatus to rain or moisture.
- Be sure to contact an authorized Samsung service center for information if you intend to install your TV in a location with heavy dust, high or low temperatures, high humidity, chemical substances, or where it will operate 24 hours a day such as in an airport, a train station, etc. Failure to do so may lead to serious damage to your TV.
- Do not expose this apparatus to dripping or splashing.

Mounting the TV on a wall

-  If you mount this TV on a wall, follow the instructions exactly as set out by the manufacturer. If it is not correctly mounted, the TV may slide or fall and cause serious injury to a child or adult and serious damage to the TV.
- Samsung Electronics is not responsible for any damage to the product or injury to yourself or others if you choose to install the wall mount on your own.

NOTE: The image shown here is for illustrative purposes only and may be subject to change.

- Samsung is not liable for product damage or personal injury when a non-VESA or non-specified wall mount is used or when the consumer fails to follow the product installation instructions.
- You can install your wall mount on a solid wall perpendicular to the floor. Before attaching the wall mount to surfaces other than plaster board, contact your nearest dealer for additional information. If you install the TV on a ceiling or slanted wall, it may fall and result in severe personal injury.
- When installing a wall mount kit, we recommend you fasten all four VESA screws.
- If you want to install a wall mount kit that attaches to the wall using two top screws only, be sure to use a Samsung wall mount kit that supports this type of installation. (You may not be able to purchase this type of wall mount kit, depending on the geographical region.)
- Do not mount the TV at more than a 15 degree tilt.
- Standard dimensions for wall mount kits are shown in the table on the Quick Setup Guide.



Do not install your wall mount kit while your TV is turned on. This may result in personal injury from electric shock.

- Do not use screws that are longer than the standard dimension or do not comply with the VESA standard screw specifications. Screws that are too long may cause damage to the inside of the TV set.
- For wall mounts that do not comply with the VESA standard screw specifications, the length of the screws may differ depending on the wall mount specifications.
- Do not fasten the screws too firmly. This may damage the product or cause the product to fall, leading to personal injury. Samsung is not liable for these kinds of accidents.
- Always have two people mount the TV onto a wall.
 - For 82 inch or larger models, have four people mount the TV onto a wall.

Providing proper ventilation for your TV

When you install your TV, maintain a distance of at least 4 inches (10 cm) between the TV and other objects (walls, cabinet sides, etc.) to ensure proper ventilation. Failing to maintain proper ventilation may result in a fire or a problem with the product caused by an increase in its internal temperature.

- When you install your TV with a stand or a wall mount, we strongly recommend you use parts provided by Samsung Electronics only. Using parts provided by another manufacturer may cause difficulties with the product or result in injury caused by the product falling.

Safety Precaution



Caution: Pulling, pushing, or climbing on the TV may cause the TV to fall. In particular, ensure your children do not hang on or destabilize the TV. This action may cause the TV to tip over, causing serious injuries or death. Follow all safety precautions provided in the Safety Flyer included with your TV. For added stability and safety, you can purchase and install the anti-tip device, referring to "Preventing the TV from falling."



WARNING: Never place a television set in an unstable location. The television set may fall, causing serious personal injury or death. Many injuries, particularly to children, can be avoided by taking simple precautions such as:

- Always use cabinets or stands or mounting methods recommended by Samsung.
- Always use furniture that can safely support the television set.
- Always ensure the television set is not overhanging the edge of the supporting furniture.
- Always educate children about the dangers of climbing on furniture to reach the television set or its controls.
- Always route cords and cables connected to your television so they cannot be tripped over, pulled or grabbed.
- Never place a television set in an unstable location.
- Never place the television set on tall furniture (for example, cupboards or bookcases) without anchoring both the furniture and the television set to a suitable support.
- Never place the television set on cloth or other materials that may be located between the television set and supporting furniture.
- Never place items that might tempt children to climb, such as toys and remote controls, on the top of the television or furniture on which the television is placed.

If the existing television set is going to be retained and relocated, the same considerations as above should be applied.

- When you have to relocate or lift the TV for replacement or cleaning, be sure not to pull out the stand.

Preventing the TV from falling

Wall-anchor (not supplied)

- Using the appropriate screws, firmly fasten a set of brackets to the wall. Confirm that the screws are firmly attached to the wall.
 - You may need additional material such as wall anchors depending on the type of wall.
- Using the appropriately sized screws, firmly fasten a set of brackets to the TV.
 - For the screw specifications, refer to the standard screw part in the table on the Quick Setup Guide.
- Connect the brackets fixed to the TV and the brackets fixed to the wall with a durable, heavy-duty string, and then tie the string tightly.
 - Install the TV near the wall so that it does not fall backwards.
 - Connect the string so that the brackets fixed to the wall are at the same height as or lower than the brackets fixed to the TV.

Operation

- This apparatus uses batteries. In your community, there might be environmental regulations that require you to dispose of these batteries properly. Please contact your local authorities for disposal or recycling information.
- Store the accessories (remote control, etc.) in a location safely out of the reach of children.
- Do not drop or strike the product. If the product is damaged, disconnect the power cord and contact a Samsung service center.
- Do not dispose of remote control or batteries in a fire.
- Do not short-circuit, disassemble, or overheat the batteries.
- CAUTION:** There is danger of an explosion if you replace the batteries used in the remote with the wrong type of battery. Replace only with the same or equivalent type.
- WARNING - TO PREVENT THE SPREAD OF FIRE, KEEP CANDLES AND OTHER ITEMS WITH OPEN FLAMES AWAY FROM THIS PRODUCT AT ALL TIMES.**



Caring for the TV

- To clean this apparatus, unplug the power cord from the wall outlet and wipe the product with a soft, dry cloth. Do not use any chemicals such as wax, benzene, alcohol, thinners, insecticide, air fresheners, lubricants, or detergents. These chemicals can damage the appearance of the TV or erase the printing on the product.
- The exterior and screen of the TV can get scratched during cleaning. Be sure to wipe the exterior and screen carefully using a soft cloth to prevent scratches.
- Do not spray water or any liquid directly onto the TV. Any liquid that goes into the product may cause a failure, fire, or electric shock.

Internet security

Samsung takes a number of steps to protect its Internet-compatible Smart TVs against unauthorized incursions and hacking. For example, certain sensitive communications between the TV and the Internet servers are encrypted. In addition, the TV's operating system has adopted controls to prevent the installation of unauthorized applications. Although we take steps to protect your Smart TV and personal information, no Internet-connected device or transmission is completely secure. We therefore encourage you to take additional steps to safeguard your TV, secure your Internet connection, and minimize the risk of unauthorized access. These steps are listed below:

- When Samsung releases software updates to improve the security of your TV, you should promptly install these updates. To automatically receive these updates, turn on **Auto Update** in the TV's menu (Ⓜ) > ≡ Menu > ⚙ Settings > Support > Software Update > Auto Update). When an update is available, a popup message appears on the TV screen. Accept the software download and update by selecting **Yes** when prompted. Take steps to secure your wireless access point and network. Your access point's manual should provide additional details about how to implement the following measures:
 - Secure your wireless access point's management settings with a unique password to prevent unauthorized changes to security related settings.
 - Implement standard encryption (e.g., WPA2 encryption) on your wireless access point to secure your wireless network signal.
 - Secure access to your wireless network with a hard-to-guess password.
 - Confirm your access point's firewall setting is enabled (if so equipped).
 - Make sure that all your Internet-connected devices are behind your network's firewall.
 - If your access point or modem has a standby mode button, use it to disconnect your home network from the Internet when it is not in use.
- Use strong passwords for all your Internet accounts (Netflix, Facebook, etc.).
- If any unexpected messages appear on your TV screen requesting permission to link a device or enable a remote session, do NOT accept.
- Do not visit suspicious web sites and do not install any suspicious programs. We recommend that users install only those authorized apps provided by Samsung through Samsung Smart Hub.

01 Initial Setup

When you turn on your TV for the first time, it immediately starts the Initial Setup. Follow the instructions displayed on the screen and configure the TV's basic settings to suit your viewing environment.

Using the TV Controller

You can turn on the TV with the **TV Controller** button at the bottom of the TV, and then use the **Control** menu. The **Control** menu appears when the **TV Controller** button is pressed while the TV is On.

- The screen may dim if the protective film on the SAMSUNG logo or the bottom of the TV is not removed. Please remove the protective film.



(A) Control menu

(B) TV Controller button / Remote control sensor

Setting the sound sensor

- This function is supported only in Q7*B/Q8*B/QN8*B/QN9*B Series.



You can turn on or off the sound sensor by using its button at the bottom of the TV.

With the TV on, push the button to the left (or back) to turn the sound sensor on or to the right (or forward) to turn it off. See the pop-up window on the TV to check whether the sound sensor is turned on or off.

- The position and shape of the sound sensor may differ depending on the model.
- During analysis using data from the sound sensor, the data is not saved.

02 Troubleshooting and Maintenance

Troubleshooting

For more information, refer to "Troubleshooting" or "FAQ" in the e-Manual.

(Ⓜ) > ≡ Menu > ⚙ Settings > Support > Open e-Manual > Troubleshooting or FAQ

If none of the troubleshooting tips apply, please visit "www.samsung.com" and click Support or contact the Samsung service center.

- This TFT LED panel is made up of sub pixels which require sophisticated technology to produce. There may be, however, a few bright or dark pixels on the screen. These pixels will have no impact on the performance of the product.
- To keep your TV in optimum condition, upgrade to the latest software. Use the **Update Now** or **Auto Update** functions on the TV's menu (Ⓜ) > ≡ Menu > ⚙ Settings > Support > Software Update > Update Now or Auto Update).

The TV won't turn on.

- Make sure that the power cord is securely plugged in to the TV and the wall outlet.
- Make sure that the wall outlet is working and the remote control sensor at the bottom of the TV is lit and glowing a solid red.
- Try pressing the **TV Controller** button at the bottom of the TV to make sure that the problem is not with the remote control. If the TV turns on, refer to "The remote control does not work."

The remote control does not work.

- Check if the remote control sensor at the bottom of the TV blinks when you press the (Ⓜ) button on the remote control.
 - When the remote's battery is discharged, charge the battery using the USB charging port (C-type), or turn over the remote to expose the solar cell to light.
- Try pointing the remote directly at the TV from 5 ft. to 6 ft. (1.5-1.8 m) away.
- If your TV came with a Samsung Smart Remote (Bluetooth Remote), make sure to pair the remote to the TV. To pair a Samsung Smart Remote, press the (☺) and (Ⓜ) buttons together for 3 seconds.

Eco Sensor and screen brightness

Eco Sensor adjusts the brightness of the TV automatically. This feature measures the light in your room and optimizes the brightness of the TV automatically to reduce power consumption. If you want to turn this off, go to (Ⓜ) > ≡ Menu > ⚙ Settings > All Settings > General & Privacy > Power and Energy Saving > Brightness Optimization.

- The eco sensor is located at the bottom of the TV. Do not block the sensor with any object. This can decrease picture brightness.

03 Specifications and Other Information

Specifications

Display Resolution

3840 x 2160

Sound (Output)

Q6*B/Q7*B Series: 20 W

Q8*B Series: 60 W (50": 40 W)

QN85BA Series: 60 W

QN85BD Series: 70 W

QN90BA Series: 60 W (43": 20 W, 50": 40 W)

QN90BD Series: 70 W (43": 20 W, 50": 40 W)

Operating Temperature

50 °F to 104 °F (10 °C to 40 °C)

Operating Humidity

10 % to 80 %, non-condensing

Storage Temperature

-4 °F to 113 °F (-20 °C to 45 °C)

Storage Humidity

5 % to 95 %, non-condensing

Notes

- This device is a **Class B digital apparatus**.
- For information about the power supply, and more information about power consumption, refer to the information on the label attached to the product.
 - On most models, the label is attached to the back of the TV. (On some models, the label is inside the cover terminal.)
- To connect a LAN cable, use a CAT 7 (*STP type) cable for the connection. (100/10 Mbps)
 - * Shielded Twisted Pair
- The images and specifications of the Quick Setup Guide may differ from the actual product.

Decreasing power consumption

When you shut the TV off, it enters Standby mode. In Standby mode, it continues to draw a small amount of power. To decrease power consumption, unplug the power cord when you don't intend to use the TV for a long time.

The terms HDMI and HDMI High-Definition Multimedia Interface, and the HDMI Logo are trademarks or registered trademarks of HDMI Licensing Administrator, Inc. in the United States and other countries.

About the Samsung SolarCell Remote (Samsung Smart Remote)

The Accessibility Shortcuts button on your remote provides easy access to the accessibility functions on your TV.

For battery recycling go to call2recycle.org; or call 1-800-822-8837



Press and hold the Volume button to display the Accessibility Shortcuts menu.

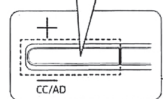



Solar Cell
Expose to light when the remote is not in use. This will extend the remote's operating time.

USB port (C-type) for charging
Used for quick charging. The LED on the front will light when charging. When the battery is fully charged, the LED will turn off.

- The USB Cable is not provided.

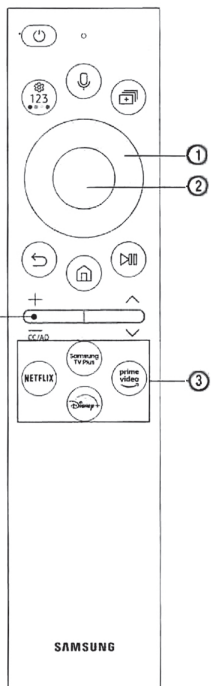

- Fire or explosion may occur, resulting in damage to the remote control or personal injury.**
- Do not apply shock to the remote control.
 - Be careful not to let foreign substances such as metal, liquid, or dust come in contact with the charging terminal of the remote control.
 - When the remote control is damaged or you smell smoke or burning fumes, immediately stop operation and then repair it at the Samsung service center.
 - Do not arbitrarily disassemble the remote control.
 - Be careful not to let infants or pets suck or bite the remote control. Fire or explosion may occur, resulting in damage to the remote control or personal injury.

NOTE: The remote control vary depend of model: The buttons on remote control may have a different name or location than the remote control shows in this manual.

Button	Description
(Power)	Press to turn the TV on or off. For The Frame model, When watching TV, press to switch to Art mode. In Art mode, press to switch to the Media Home. Press and hold to turn off the TV completely.
(Voice Assistant)	Runs Voice Assistant. Press and hold the button, say a command, and then release the button to run Voice Assistant. <ul style="list-style-type: none"> The supported Voice Assistant's languages and features may differ by geographical region. Keep the remote more than 0.6 inches (15.24 mm) from your face when using and speaking to Voice Assistant through the mic on the remote.
(Settings - Number - Color button)	Each time you press this button, Settings menu / virtual numeric pad / Option pad with Color buttons are displayed alternately. <ul style="list-style-type: none"> Use this button to access additional options that are specific to the feature in use. Press to bring up the virtual numeric pad on the screen. Use the numeric keypad to enter numeric values. Select numbers and then select Done or Enter Number to enter a numeric value. Use to change the channel, enter a PIN, enter a ZIP code, etc.
(Multi View)	Press the button to directly enter the Multi View function.
(up, down, left, right)	Use to navigate the menu or move the focus to highlight items on the Home Screen.
(Select)	Selects or runs a focused item. When pressed while you are watching a broadcast program, detailed program information appears.
(Return)	Press to return to the previous menu. When pressed for 1 second or more, the running function is terminated. When pressed while you are watching a program, the previous channel appears.
(Smart Hub)	Press to switch to the Media Home. From the Ambient Mode screen, press to switch to the Ambient Mode Home. For The Frame model, in Art mode, press to switch to the Art Home.
(Play/pause)	When pressed, the playback controls appear. Using these controls, you can control the media content that is playing. To use Game Bar, press and hold the button in Game Mode. <ul style="list-style-type: none"> Game Bar may not be supported depending on the model or geographical area.
(Volume)	Move the button up or down to adjust the volume. To mute the sound, press the button.
(Channel)	Move the button up or down to change the channel. To see the Guide screen, press the button. Press and hold the button up or down to quickly change the channel.
(Launch app button)	Launch the app indicated by the button. <ul style="list-style-type: none"> Available apps may differ depending on the geographical area or contents provider.
(Pairing)	If the Samsung Smart Remote does not pair to the TV automatically, point it at the front of the TV, and then press and hold the and buttons simultaneously for 3 seconds or more.

- Use the Samsung Smart Remote less than 20 feet (6 m) from the TV. The usable distance may vary with the wireless environmental conditions.
- The images, buttons, and functions of the Samsung Smart Remote may differ with the model or geographical area.
 - The Universal Remote function operates normally only when you use the Samsung Smart Remote that comes with the TV.
 - It is recommended to use an original Samsung charger. Otherwise, it may cause performance degradation or failure of the product. In this case, the warranty service is not applicable.
 - When the remote control does not work due to low battery, charge it by using the USB-C type port.

Using Accessibility Functions (may differ with model)

Accessing your TV's accessibility functions

The Accessibility Shortcuts button on your remote provides easy access to the accessibility functions on your TV.

- Press and hold the Volume button to display the Accessibility Shortcuts menu.
- Some functions may not appear depending on the access method.

Voice Guide Settings

You can activate voice guides that describe the menu options aloud to aid the visually impaired. To activate this function, set Voice Guide to On. With Voice Guide on, the TV provides voice guides for channel change, volume adjust, information on current and upcoming programs, schedule viewing, other TV functions, various content in the Web Browser, and in Search.

- You can configure the volume, speed, pitch, and level of the Voice Guide.
- The Voice Guide is provided in the language that is specified on the Language screen. English is always supported. However, some languages are not supported by Voice Guide even though they are listed in the Language screen.

TV Background Volume

By default, the volume of the broadcast content is set to be low so that you can hear the voice guide clearly. When the content volume is too low while the voice guide is coming out, you can adjust the content volume.

Audio (Video) Description

You can activate an audio guide that provides an audio description of video scenes for the visually impaired. This function is only available with broadcasts that provide this service.

NOTE: The image shown here is for illustrative purposes only and may be subject to change.

Caption Settings

Set Caption to On to watch programs with the captions displayed.

- Captions are not displayed by programs that do not support captions.
- This function has no relationship with the features for controlling subtitles of DVD or Blu-ray players. To control DVD or Blu-ray subtitles, use the subtitle feature of the DVD or Blu-ray player and the player's remote control.

Separate Closed Caption

- You can display the caption in the area separated from the broadcast screen.

Caption Mode

- Default / CC1 ~ CC4 / Text1 ~ Text4**
Operates in either analog TV channel mode or when a signal is supplied from an external device to the TV. (Depending on the broadcast signal, the analog caption function may or may not work with digital channels.)
- Default / Service1 ~ Service6 / CC1 ~ CC4 / Text1 ~ Text4**
Works with digital channels. These functions may not be available in digital caption mode depending on the broadcast.

Digital Caption Options

You can change the font color, background color, size settings, and position, etc.

- The foreground and background colors and opacity settings cannot be the same.
- The Position function is activated only for programs that support broadcast captions.

Sign Language Zoom Settings

You can zoom in the sign language screen when the program you are watching provides it. First, set Sign Language Zoom to On, and then select Edit Sign Language Zoom to change the position and magnification of the sign language screen.

Sign Language Guide Settings

Provides a description of menu items with sign language.

Learn TV Remote

This function helps individuals with a visual impairment to learn the positions of the buttons on the remote control. When this function is activated, you can press a button on the remote control and the TV will tell you its name. Press the (Return) button twice to exit Learn TV Remote.

Learn Menu Screen

Learn the menus on the TV screen. Once enabled, your TV will tell you the structure and features of the menus you select.

Picture Off

Turn off the TV screen and provide only sound to reduce overall power consumption. When you press any button on the remote control with the screen off, the TV screen is returned to on.

Multi-output Audio

You can turn on the TV speaker and a Bluetooth device at the same time. When this function is active, you can set the volume of the Bluetooth device higher than the volume of the TV speaker.

- This function may not be supported depending on the model or geographical area.

High Contrast

You can change major service screens to white text on a black background or change the transparent TV menus to opaque so that text can be more easily read. To activate this function, set High Contrast to On.

Enlarge

You can enlarge the size of the font on the screen. To activate, set Enlarge to On.

Grayscale

You can change the color of the TV screen to a black and white tone to sharpen blurred edges caused by colors.

- If Grayscale is on, some Accessibility menus are not available.
- This function may not be supported depending on the model or geographical area.

Color Inversion

You can invert the colors of the text and background for the setting menus displayed on the TV screen to make it easier to read them.

- If Color Inversion is on, some Accessibility menus are not available.
- This function may not be supported depending on the model or geographical area.

Remote Button Repeat Settings

You can configure the operation speed of the remote control buttons so that they slow down when you continually press and hold them. First, set Slow Button Repeat to On, and then adjust the operation speed in Repeat Interval.

REFURBISHED PRODUCT LIMITED NINETY DAY WARRANTY

The **Refurbished Product Service Center** offers the following WARRANTY to the ORIGINAL purchaser of a product which we have refurbished.

This product that has been refurbished is warranted against any electronic or mechanical defects for a period of NINETY DAYS from the date of the original purchase by the consumer. Since this unit was sold as a refurbished item, the warranty does not apply to any cosmetic appearance items such as scratches. Should a defect occur, the **Refurbished Product Service Center** will repair or, at its option, replace defective unit/parts with new or rebuilt materials without charge for either parts or labor. Replacement unit/parts will be warranted for the remaining portion of the original warranty period.

This warranty does not cover installation or damage from accident, misuse, abuse, improper wiring, incorrect voltage, operating the unit against the instructions in the owner's manual or any product which has been opened, altered, or tampered with.

This warranty does not cover costs for removal and or installation of the unit for repair. Under no circumstances shall the service center be liable for any special, incidental or consequential damages or for any other expenses incurred by reason of use or sale of this product. This warranty is in lieu of any other warranties expressed or implied warranty of merchantability of fitness for particular use or otherwise.

This warranty gives the consumer specific legal rights and they may also have other rights which vary from State to State. Some States do not follow the exclusion or limitation of incidental or consequential damages, hence the above exclusion and limitations may not apply.

Refurbished Product Service Center
13225 Marquardt Avenue Santa Fe Springs, CA 90670

WARRANTY REPAIR INFORMATION

If you need service on your unit during the 90 day warranty period; please go to www.ConsumerServiceRefurbish.com or call the Refurbished Product Service Center at 562-946-3531 to obtain the required claim number. Once you obtain your claim number, pack the unit properly (the original carton is ideal for this purpose) along with a copy of your purchase receipt.

Send the unit freight prepaid and insured to:

Refurbished Product Service Center,

Att: Customer Service Department 13225 Marquardt Avenue Santa Fe Springs, CA 90670

Your unit will be promptly exchanged and returned to you.

We will refuse to accept delivery of the returned unit unless the assigned claim number appears on the outside of the shipping carton.

Owner's Information
(Keep for your permanent records)

NAME: _____

ADDRESS: _____

CITY: _____ STATE: _____ ZIP CODE: _____

PHONE: _____ E-MAIL: _____

MODEL: _____ SERIAL NO.: _____

Licenses

Dolby Audio

POWERED BY

HEVC Advance
Covered by Patents at patentlist.hevcadvance.com

QUICK SET

HDMI
HIGH DEFINITION MULTIMEDIA INTERFACE

PRINTED IN MEXICO/ SC:24-08-2022

Obpn:BN68-13696A-00 / Pags:TAB

Shnmdl:QN75Q60BDFXZA_B / Elbrd:J.E.

Add: QN50Q60B / QN55Q60B / QN5580B / QN55QN85B / QN65Q60B / QN65Q80B / QN65QN90B / QN75Q60B / QN75Q80B / QN75QN85B / QN75QN90B / QN85Q60B / QN85Q80B / QN85QN85B / QN85QN90B.

8 0 4 1 0 6 8 5 2



SAMSUNG QUICK SETUP GUIDE



804006852A

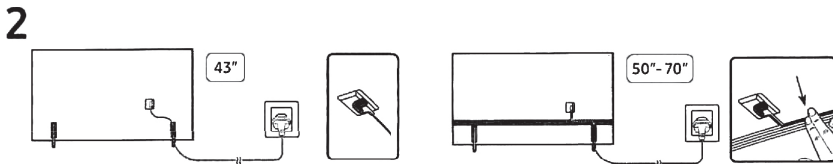
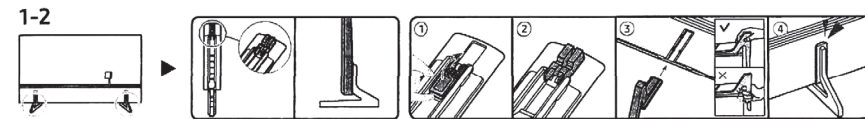
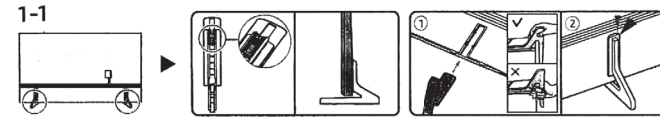
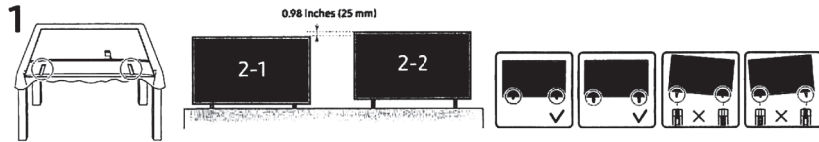
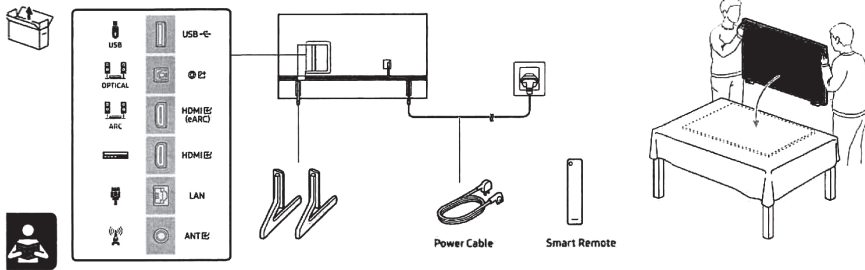

The cables mentioned in this guide is not supplied with your unit.

Note: The remote control vary depend of model: The buttons on the remote control may have a different name or location than the remote control shows in this manual.

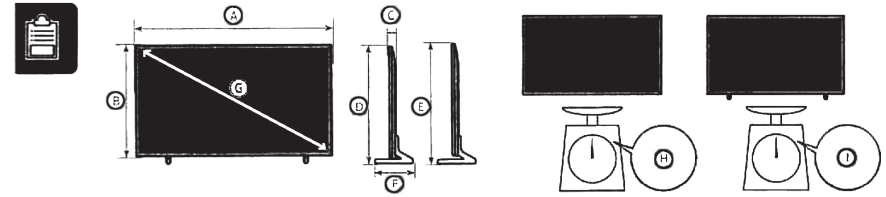

	A	B	C	D	E	F	G	H	I
QN43Q6*B	38.0 inches (965.5 mm)	22.0 inches (559.4 mm)	1.0 inches (25.7 mm)	23.5 inches (598.1 mm)	24.5 inches (623.1 mm)	7.1 inches (181.0 mm)	42.5 inches	18.5 lbs (8.4 kg)	19.0 lbs (8.6 kg)
QN50Q6*B	44.0 inches (1118.3 mm)	25.4 inches (644.1 mm)	1.0 inches (25.7 mm)	26.8 inches (681.7 mm)	27.8 inches (706.7 mm)	8.8 inches (224.0 mm)	49.5 inches	25.4 lbs (11.5 kg)	26.0 lbs (11.8 kg)
QN55Q6*B	48.5 inches (1232.1 mm)	27.9 inches (708.3 mm)	1.0 inches (25.7 mm)	29.4 inches (745.9 mm)	30.4 inches (770.9 mm)	8.8 inches (224.0 mm)	54.6 inches	34.2 lbs (15.5 kg)	34.8 lbs (15.8 kg)
QN60Q6*B	53.3 inches (1353.0 mm)	30.6 inches (776.3 mm)	1.0 inches (25.7 mm)	32.2 inches (817.4 mm)	33.2 inches (842.4 mm)	10.8 inches (274.0 mm)	60.1 inches	41.0 lbs (18.6 kg)	41.9 lbs (19.0 kg)
QN65Q6*B	57.1 inches (1450.9 mm)	32.7 inches (831.4 mm)	1.0 inches (25.7 mm)	34.3 inches (872.2 mm)	35.3 inches (897.2 mm)	10.8 inches (274.0 mm)	64.5 inches	46.1 lbs (20.9 kg)	47.0 lbs (21.3 kg)
QN70Q6*B	61.4 inches (1559.7 mm)	35.5 inches (902.1 mm)	1.0 inches (26.6 mm)	37.0 inches (939.6 mm)	38.0 inches (964.6 mm)	12.6 inches (320.0 mm)	69.5 inches	62.8 lbs (28.5 kg)	64.2 lbs (29.1 kg)

* : 0-9, A-Z

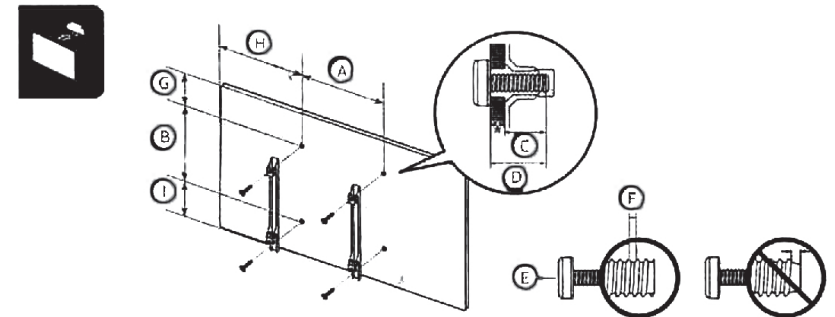

	VESA A x B (mm)	C (mm)	D	E x 4	F (mm)	G (inches)	H (inches)	I (inches)
QN43Q6*B	200 x 200	11-13	C + *	M8	1.25	7.6	15.1	6.6
8.2						18.1	9.3	
9.4						20.3	10.6	
QN60Q6*B	400 x 300	11-13	C + *	M8	1.25	8.2	18.8	10.5
10.4						20.7	10.5	
9.6						22.8	14.1	

* : 0-9, A-Z

* : Wall-Mount Bracket

Note: The image shown here is for illustrative purposes only and may be subject to change. The actual number of ports and their locations may vary depending on the model.

804006852A



PRINTED IN MEXICO / SC:25-08-2022
OBPN: BN68-13691A-01 / Elbrd: J.E.
SHNMDL: QN55Q60BDFXZA_B 1P