



**FOODI® POWER BLENDER & PROCESSOR SYSTEM**  
with Smoothie Bowl Maker and Nutrient Extractor\*

"Recipe book is not included"

804106834

**IMPORTANT SAFETY INSTRUCTIONS**  
PLEASE READ CAREFULLY BEFORE USE • FOR HOUSEHOLD USE ONLY

	Read and review instructions for operation and use.
	Indicates the presence of a hazard that can cause personal injury, death or substantial property damage if the warning included with this symbol is ignored.
	For indoor and household use only.
When using electrical appliances, basic safety precautions should always be followed, including the following:	

**WARNING**

- Read all instructions prior to using the appliance and its accessories.
- Carefully observe and follow all warnings and instructions. This unit contains electrical connections and moving parts that potentially present risk to the user.
- Take your time and exercise care during unpacking and appliance setup. This appliance contains sharp, loose blades that can cause injury if mishandled.
- Take inventory of all contents to ensure you have all parts needed to properly and safely operate your appliance.
- Blades are sharp. Handle carefully.
- This product is provided with a Stacked Blade Assembly. ALWAYS exercise care when handling blade assemblies. The blade assemblies are sharp and are NOT locked in place in their containers. The blade assemblies are designed to be removable to facilitate cleaning and replacement if needed. ONLY grasp the blade assembly by the top of the shaft. Failure to use care when handling the blade assemblies will result in a risk of laceration.
- ALWAYS exercise care when handling the Hybrid Edge™ Blades Assembly. The blades are sharp. ONLY grasp the Hybrid Edge Blades Assembly by the outer perimeter of the blade assembly base. Failure to use care when handling the blade assembly will result in a risk of laceration.
- Turn the appliance OFF, then unplug the appliance from the outlet when not in use, before assembling or disassembling parts, and before cleaning. To unplug, grasp the plug by the body and pull from the outlet. NEVER unplug by grasping and pulling the flexible cord.
- Before use, wash all parts that may contact food. Follow washing instructions covered in this instruction manual.
- Before each use, inspect blade assemblies for damage. If a blade is bent or damage is suspected, contact a service center.
- DO NOT use this appliance outdoors. It is designed for indoor household use only.
- This appliance has a polarized plug (one prong is wider than the other). To reduce the risk of electric shock, this plug will fit in a polarized outlet only one way. If the plug does not fit fully in the outlet, reverse the plug. If it still does not fit, contact a qualified electrician. DO NOT modify the plug in any way.
- DO NOT operate any appliance with a damaged cord or plug, or after the appliance malfunctions or is dropped or damaged in any manner. contact a service center.
- This appliance has important markings on the plug blade. The entire supply cord is not suitable for replacement. If damaged, please contact a service center.
- Extension cords should NOT be used with this appliance.
- To protect against the risk of electric shock, DO NOT submerge the appliance or allow the power cord to contact any form of liquid.
- DO NOT allow the cord to hang over the edges of tables or counters. The cord may become snagged and pull the appliance off the work surface.
- DO NOT allow the unit or the cord to contact hot surfaces, including stoves and other heating appliances.
- ALWAYS use the appliance on a dry and level surface.
- DO NOT allow children to operate this appliance or use as a toy. Close supervision is necessary when any appliance is used near children.

- This appliance is NOT intended to be used by people with reduced physical, sensory or mental capabilities, or lack of experience and knowledge, unless they have been given supervision or instruction concerning use of the appliance by a person responsible for their safety.
- ONLY use attachments and accessories that are provided with the product or are recommended by SharkNinja. The use of attachments, including canning jars, not recommended or sold by SharkNinja may cause fire, electric shock, or injury.
- NEVER place a blade assembly on the motor base without it first being attached to its corresponding container (pitcher, cup or bowl maker) with the lid also in place.
- Keep hands, hair, and clothing out of the container when loading and operating.
- During operation and handling of the appliance, avoid contact with moving parts.
- DO NOT fill containers past the MAX FILL or MAX LIQUID lines.
- DO NOT operate the appliance with an empty container.
- DO NOT microwave any containers or accessories provided with the appliance.
- NEVER leave the appliance unattended while in use.
- DO NOT blend hot liquids. Doing so may result in pressure buildup and steam exposure that can pose a risk of the user being burned.
- DO NOT process dry ingredients without adding liquid to the single-serve cup, Smoothie Bowl Maker, or Pitcher. They are not intended for dry blending.
- DO NOT perform grinding operations.
- NEVER operate the appliance without lids and caps in place. DO NOT attempt to defeat the interlock mechanism. Ensure the container and lid are properly installed before operation.
- Before operation, ensure all utensils are removed from containers. Failure to remove utensils can cause containers to shatter and potentially result in personal injury and property damage.
- Keep hands and utensils out of containers while chopping to reduce the risk of severe personal injury or damage to the blender/food chopper. A scraper may be used ONLY when the blender or processor is not running.
- If you find unmixed ingredients sticking to the sides of the cup, stop the appliance, remove the blade assembly, and use a scraper to dislodge ingredients.
- DO NOT open the pitcher's pour spout cap while blender is operating.
- If you find unmixed ingredients sticking to the sides of the pitcher, stop the appliance, remove the lid, and use a spatula to dislodge ingredients. NEVER insert your hands into the pitcher, as you may contact one of the blades and experience a laceration.
- DO NOT attempt to remove the container or lid from the motor base while the blade assembly is still spinning. Allow the appliance to come to a complete stop before removing lids and containers.
- If the appliance overheats, a thermal switch will activate and temporarily disable the motor. To reset, unplug the appliance and allow it to cool for approximately 15 minutes before using again.
- DO NOT expose the containers and accessories to extreme temperature changes. They may experience damage.
- Upon completion of processing, ensure the blade assembly is removed BEFORE emptying container's contents. Remove the blade assembly by carefully grasping the top of the shaft and lifting it from the container. Failure to remove the container assembly before emptying the container results in a risk of laceration.

- If using the pitcher's pour spout, hold the cover in place on the container or ensure lid lock is engaged when pouring to avoid risk of injury.
- Remove the Hybrid Edge™ Blades Assembly from the single-serve cup or Smoothie Bowl Maker upon completion of blending. DO NOT store ingredients before or after blending them in the cup or bowl with the blade assembly attached. Some foods may contain active ingredients or release gases that will expand if left in a sealed container, resulting in excessive pressure buildup that can pose a risk of injury. For ingredient storage in the cup, use only Spout Lid or Storage Lid to cover.
- The maximum wattage rating for this appliance is based on the configuration of the Hybrid Edge Blades Assembly and single-serve cup. Other configurations may draw less power or current.
- DO NOT submerge the motor base or control panel in water or other liquids. DO NOT spray motor base or control panel with any liquid.
- DO NOT attempt to sharpen blades.
- Turn off the appliance and unplug the motor base before cleaning.

**SAVE THESE INSTRUCTIONS**

**PARTS**

There are a variety of accessories that are compatible with this blender series.

NOTE: The top flap of your box shows the select accessories that are included with your model.

- A Pitcher Lid
  - B \* Power Blender & Processor Pitcher
  - C Motor Base (attached power cord not shown)
  - D Total Crushing™ & Chopping Blade Assembly (Stacked Blade Assembly)
  - E Dough Blade Assembly
  - F Hybrid Edge™ Blades Assembly
  - G Spout Lid
  - H Nutrient Extraction\*\* Cup
  - I Storage Lid
  - J Smoothie Bowl Maker with built-in tamper
- \*64 oz. max liquid capacity.

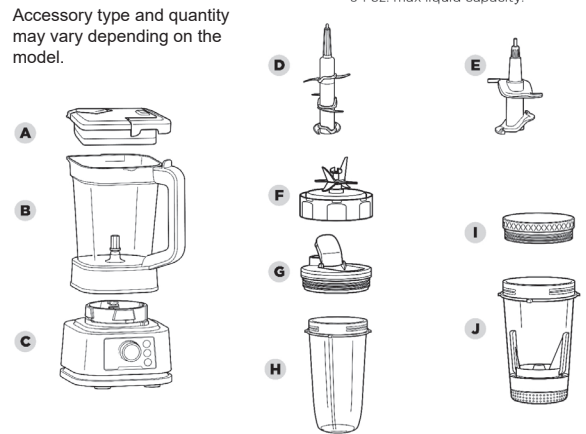

NOTE: The Hybrid Edge Blades Assembly is not compatible with other Ninja products.

NOTE: Number of cups, bowl makers, and lids vary by model.

\*\*Extract a drink containing vitamins and minerals from fruits and vegetables.

**BEFORE FIRST USE**

IMPORTANT: Review all warnings on before proceeding.

**DID YOU KNOW?**

- You can take your drinks on the go using the spout lid.

NOTE: All attachments are BPA free and dishwasher safe. Ensure blade assemblies and lids are removed from the containers before placing in the dishwasher. Exercise care when handling blade assemblies.

- Remove all packaging materials from the unit. Exercise care when unpacking blade assemblies, as the blades are sharp.
- The Stacked Blade Assembly is NOT locked in place in the container. Handle the Stacked Blade Assembly and Dough Blade Assembly by grasping the top of the shaft.
- Handle the Hybrid Edge™ Blades Assembly by grasping around the perimeter of the blade assembly base.
- Wash containers, lids, and blade assemblies in warm, soapy, water using a dishwashing utensil with a handle to avoid direct contact with the blades. Exercise care when handling blade assemblies, as the blades are sharp.
- Thoroughly rinse and air-dry all parts.

**GETTING TO KNOW THE SMOOTHIE BOWL MAKER**

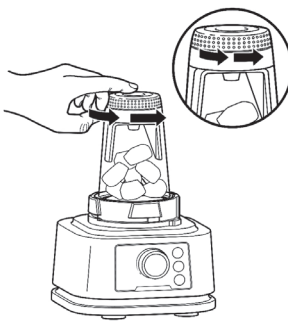

Powering through tough and frozen ingredients used to require a lot of stopping, scraping, and recipe tinkering. But now, it's easier than ever to create thick and spoonable smoothie bowls, nut butters, and more. All you have to do is twist the built-in tamper while blending to push ingredients down toward the blade.

**USING THE CONTROL PANEL**

Use the Power button to turn the unit on or off.  
**SWITCHING BETWEEN AUTO-IQ® AND MANUAL MODE:** To toggle between Auto-IQ Mode and Manual Mode, press the IQ/MANUAL button.  
**NOTE:** In Manual Mode, Auto-IQ programs will not illuminate on the control panel.

**AUTO-IQ MODE**  
6 unique timed programs customized to take the guesswork out of making great drinks and meals.

**MANUAL MODE**  
Choose from 10 different speeds for total control of your blending in the pitcher.

**NOTE:** Only speed 10 is available when using the Smoothie Bowl Maker or Single-Serve Cup.



**SELECT AND RUN AN AUTO-IQ PROGRAM**  
Use the dial to select the desired program, then press START/STOP to begin. As the program runs, the timer will count down. When the countdown ends, blending will stop automatically.

**SELECT AND RUN A MANUAL PROGRAM**  
Turn the dial from speed 1 to speed 10. Press START/STOP to begin and end blending.

**PULSE**  
Offers greater control of pulsing and blending. Operates only when PULSE is pressed. Use short presses for short pulses and long presses for long pulses.

**USING VARIABLE SPEED CONTROL & THE POWER BLENDER & PROCESSOR PITCHER**

NOTE: If using the Dough Blade Assembly, only use speeds 1 or 2.

**START SLOW**  
Always start at a low speed (1-3) to better incorporate ingredients and prevent them from sticking to the side of the vessel.

**DIAL UP THE SPEED**  
Smoother blends call for higher speeds. Low speeds are great for chopping veggies and mixing dough, but you'll need to ramp up for purees and dressings.

**HIGH-SPEED BLENDING**  
Blend until you get your desired consistency. The longer you blend, the better the breakdown and smoother the outcome will be.

**USING THE AUTO-IQ® PROGRAMS**

**AUTO-IQ PROGRAMS**  
Intelligent preset programs combine unique blending and pausing patterns that do the work for you. Once a preset program is selected, it will start immediately and automatically stop when blending is complete. To stop blending before the end of the program, press the currently active button again.

NOTE: The unit can detect if the pitcher or the cup/bowl is installed on the motor base. Only the functions available for a particular container will illuminate on the control panel.



**AUTO-IQ PROGRAMS FOR THE PITCHER**

**SMOOTHIE**  
Combine your favorite fresh or frozen ingredients, liquids, and powders to create smoothies and protein shakes.

**BOWL**  
Make thick, spoonable smoothie bowls to creamy frozen yogurt to refreshing sorbets.

**CHOP**  
Timed pulses and pauses give you consistent chopping results. Run program once for a large chop, twice for a small chop and three times if you prefer to mince.

**DOUGH**  
Use with the Dough Blade Assembly, create delicious dough for pizza, bread, and baked goods like cookies.

NOTE: For best results when using the Single-Serve Cup, use the Auto-IQ Programs, EXTRACT & SMOOTHIE.

**BOWL**  
Make thick, spoonable single-serve smoothie bowls to creamy frozen yogurt to refreshing sorbets.

NOTE: For best results when using the Smoothie Bowl Maker, use the Auto-IQ Programs, SPREAD & BOWL.

**AUTO-IQ PROGRAMS FOR THE SINGLE-SERVE CUP AND BOWL MAKER**

**EXTRACT**  
Ideal for tough, leafy, or fibrous whole fruits and vegetables, including their skins, seeds, and stems.

**SMOOTHIE**  
Combine your favorite fresh or frozen ingredients, liquids, and powders to create smoothies and protein shakes.

**USING THE POWER BLENDER & PROCESSOR PITCHER & STACKED BLADE ASSEMBLY**

**IMPORTANT:** As a safety feature, when the unit is powered on, if the pitcher and lid are not properly installed, the timer will display "--" and the motor will be disabled. If this happens, repeat step 5 on the following page. When the pitcher and lid are properly installed, and the unit is powered on, the program button LEDs will illuminate, indicating the appliance is ready to use.

NOTE: Auto-IQ® programs have pauses and changes in speed throughout the cycle.

NOTE: DO NOT add ingredients before completing installation of the Stacked Blade Assembly.

NOTE: If the Stacked Blade Assembly is not fully seated, you will not be able to install and lock the lid.

NOTE: The pitcher lid handle will not fold down unless it is attached to the pitcher.

- Plug in motor base and place on a clean, dry, level surface such as a countertop or table.



- Lower the pitcher onto the motor base. The handle should be aligned slightly to the right and the pitcher should be oriented so the LOCK symbols are visible on the motor base. Rotate the pitcher clockwise until it clicks into place.



- Exercising care, grasp the Stacked Blade Assembly by the top of the shaft and place it onto the drive gear inside the pitcher. Note that the blade assembly will fit loosely onto the drive gear.

- Add ingredients to the pitcher. DO NOT add ingredients past the MAX LIQUID line on the pitcher.

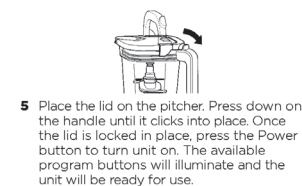

- Place the lid on the pitcher. Press down on the handle until it clicks into place. Once the lid is locked in place, press the Power button to turn unit on. The available program buttons will illuminate and the unit will be ready for use.

- If using an Auto-IQ® program, use the dial to select the program that best suits your desired output, then press START/STOP. The preset feature will automatically stop at the end of the program. To stop the unit at any time, press START/STOP.

- For Manual mode, press IQ/MANUAL. Use the dial to select your desired speed, ranging from 1 to 10, and press START/STOP. Once the ingredients have reached your desired consistency, press START/STOP, and wait for the unit to come to a complete stop.

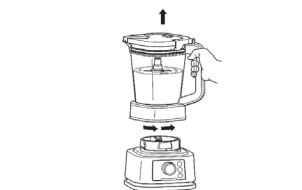

- Remove the pitcher from the motor base by turning it counterclockwise and then lifting up.

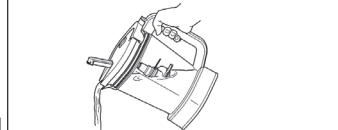

- To pour out thinner mixtures, ensure the lid is locked in place, then open the pour spout cap.

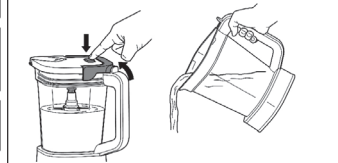

- For thicker mixtures that cannot be emptied through the pour spout, remove the lid and Stacked Blade Assembly before pouring. To remove the lid, press the RELEASE button and lift the handle. To remove the blade assembly, carefully grasp it by the top of the shaft and pull straight up. The pitcher can then be emptied.

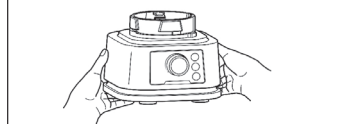

- Turn the unit off by pressing the Power button. Unplug the unit when finished. Refer to the Care & Maintenance section for cleaning and storage instructions.

- Plug in motor base and place on a clean, dry, level surface such as a countertop or table.



- Lower the pitcher onto the motor base. The handle should be aligned slightly to the right and the pitcher should be oriented so the LOCK symbols are visible on the motor base. Rotate the pitcher clockwise until it clicks into place.



- Exercising care, grasp the Dough Blade Assembly by the top of the shaft and place it onto the drive gear inside the pitcher. Note that the blade assembly will fit loosely onto the drive gear.

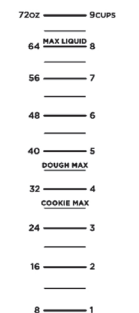

**4** Add ingredients to the pitcher. **DO NOT** add ingredients past the **DOUGH MAX** or **COOKIE MAX** line on the pitcher.



**5** Place the lid on the pitcher. Press down on the handle until it clicks into place. Once the lid is locked in place, press the Power button to turn unit on. The available program buttons will illuminate and the unit will be ready for use.



**6a** If using an Auto-iQ® program, use the dial to select DOUGH, then press START/STOP. The preset feature will automatically stop at the end of the program. To stop the unit at any time, press START/STOP.

**6b** For Manual mode, press IQ/MANUAL. Use the dial to select speeds 1 or 2, and press START/STOP. Once the ingredients have reached your desired consistency, press START/STOP, and wait for the unit to come to a complete stop.

**IMPORTANT:** Only use speeds 1 or 2 when using the Dough Blade Assembly.



**7** Remove the pitcher from the motor base by turning it counterclockwise and then lifting up.

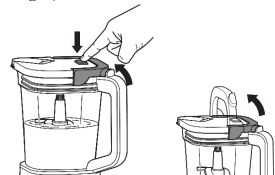

**8** Remove the lid and Dough Blade Assembly before removing contents. To remove the lid, press the **RELEASE** button and lift the handle. To remove the blade assembly, carefully grasp it by the top of the shaft and pull straight up. The pitcher can then be emptied.

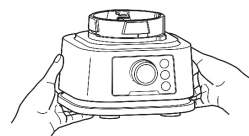

**9** Turn the unit off by pressing the Power button. Unplug the unit when finished. Refer to the Care & Maintenance section for cleaning and storage instructions.

## USING THE SMOOTHIE BOWL MAKER

**NOTE:** If the unit is plugged in and powered on, but the bowl and blade assembly is not properly installed, the timer will display "--" and the motor will be disabled.

**NOTE:** Auto-iQ® programs have pauses and changes in speed throughout the cycle.

**1** Plug in motor base and place on a clean, dry, level surface such as a countertop or table.

**2** Add ingredients to the Smoothie Bowl Maker. **DO NOT** add liquid past the **LIQUID FILL** line or ingredients past the **MAX FILL** line.

**3** Place the Hybrid Edge™ Blades Assembly on the top of the bowl maker and turn clockwise to seal.

**4** Turn the bowl maker upside down and install on motor base by aligning the tabs on the bowl maker with the slots on the base. Then, rotate bowl maker clockwise until it clicks. Once locked in place, press the Power button to turn unit on. The available program buttons will illuminate and the unit will be ready for use.

**NOTE:** While processing, twist the built-in tamper counterclockwise continuously.

**5a** If using an Auto-iQ program, use the dial to select the program that best suits your desired output, then press START/STOP.

During the blending process, ensure to twist the built-in tamper **counterclockwise** continuously. The preset feature will automatically stop at the end of the program. To stop the unit at any time, press START/STOP.

**5b** For Manual mode, press IQ/MANUAL. With speed 10 on the display, press START/STOP. During the blending process, twist the built-in tamper **counterclockwise** continuously. Once the ingredients have reached your desired consistency, press START/STOP and wait for the unit to come to a complete stop.

**NOTE:** Only speed 10 is available when using the bowl maker.

**6** Remove the bowl maker from the motor base by turning it counterclockwise and then lifting up.

**7** Remove the blade assembly by twisting counterclockwise. **DO NOT** store blended contents with the blade assembly attached. Only use the Spout Lid or Storage Lid to cover. Exercise care when handling the blade assembly, as the blades are sharp.

**8** To enjoy on the go, place the Spout Lid or Storage Lid onto the bowl maker and twist lid clockwise until firmly sealed.

**9** Turn the unit off by pressing the Power button. Unplug the unit when finished. Refer to the Care & Maintenance section for cleaning and storage instructions.

## USING THE NUTRIENT EXTRACTION\* CUP

**1** Plug in motor base and place on a clean, dry, level surface such as a countertop or table.



**2** Add liquid then ingredients to the single-serve cup. **DO NOT** add ingredients past the **MAX LIQUID** line.



**3** Place the Hybrid Edge™ Blades Assembly on the top of the cup and turn clockwise to seal.

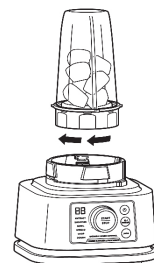

**4** Turn the cup upside down and install on the motor base by aligning the tab on the cup with the slots on the base. Then, rotate cup clockwise until it clicks. Once locked in place, press the Power button to turn unit on. The available program buttons will illuminate and the unit will be ready for use.

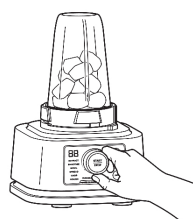

**5a** If using an Auto-iQ program, use the dial to select the program that best suits your desired output, then press START/STOP. The preset feature will automatically stop at the end of the program. To stop the unit at any time, press START/STOP.

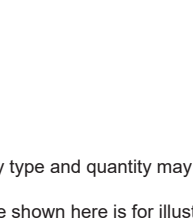

**5b** For Manual mode, press IQ/MANUAL. With speed 10 on the display, press START/STOP. Once the ingredients have reached your desired consistency, press START/STOP and wait for the unit to come to a complete stop.

**NOTE:** Only speed 10 is available when using the single-serve cup.

**6** Remove the cup from the motor base by turning it counterclockwise and then lifting up.



**7** Remove the blade assembly by twisting counterclockwise. **DO NOT** store blended contents with the blade assembly attached. Only use the Spout Lid or Storage Lid to cover. Exercise care when handling the blade assembly, as the blades are sharp.



**8** To enjoy on the go, place the Spout Lid or Storage Lid onto the cup and twist lid clockwise until firmly sealed.

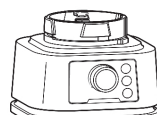

**9** Turn the unit off by pressing the Power button. Unplug the unit when finished. Refer to the Care & Maintenance section for cleaning and storage instructions.

\*Extract a drink containing vitamins and minerals from fruits and vegetables.

Accessory type and quantity may vary depending on the model.

The image shown here is for illustrative purposes only and may be subject to change.

Illustrations may differ from actual product. We are constantly striving to improve our products; therefore the specifications contained herein are subject to change without notice.

## CARE & MAINTENANCE

### USING THE BLENDER FOR STUCK-ON INGREDIENTS

**NOTE:** For best results, use a dishwasher to remove stuck-on ingredients.

**1** After processing, immediately clean the container and blade assembly under warm, soapy water.  
**2** Depending on the container, fill with soap and water according to the following instructions:

**72-ounce Pitcher:**

1 OR 2 SMALL DROPS OF DISH SOAP



Dish soap not included

With the dough or stacked blade assembly installed, fill with warm water up to DOUGH MAX line and add 1 or 2 small drops dish soap. Secure pitcher lid, and ensure the pour spout is securely closed.

**Smoothie Bowl Maker:**

1 OR 2 SMALL DROPS OF DISH SOAP

FILL WATER TO TOP OF BUILT-IN TAMPER



Fill with warm water up to top of built-in tamper and add 1 or 2 small drops dish soap. Install blade assembly.

**NOTE:** If using the Smoothie Bowl Maker, twist the built-in tamper counterclockwise continuously while cleaning.

**Single-Serve Cup:**

1 SMALL DROP OF DISH SOAP

FILL WATER HALFWAY



Fill halfway with warm water and add 1 small drop dish soap. Install blade assembly.

**3** Install the container on the motor base. Select BOWL, then press START/STOP.

**4** Once program is complete, thoroughly rinse container and blade assembly under warm, soapy water.

### CLEANING

#### Hand-Washing

Wash containers, lids, and blade assemblies in warm, soapy water. Use a dishwashing utensil with a handle to avoid direct contact with the blades when dealing with stuck-on ingredients, like doughs and batters. Exercise care when handling the blade assembly as the blades are sharp. Thoroughly rinse and air-dry all parts.

**NOTE:** The built-in tamper in the Smoothie Bowl Maker is not removable.

#### Dishwasher

Containers, lids, and blade assemblies are dishwasher safe. Ensure the blade assembly and lid are removed from the container before placing in the dishwasher.

**NOTE:** For best results, use a dishwasher to remove stuck-on ingredients.

#### Motor Base

Unplug the motor base before cleaning. Wipe motor base with a clean, damp cloth. **DO NOT** use abrasive cloths, pads, or brushes to clean the base.

### STORING

For cord storage, wrap cord with hook-and-loop fastener near the back of the motor base. **DO NOT** wrap the cord around the bottom of the base for storage.

**DO NOT** store blended or unblended ingredients in the cup or bowl with the blade assembly attached.

**DO NOT** stack items on top of the containers. Store any remaining attachments alongside the unit or in a cabinet where they will not be damaged or create a hazard.

### RESETTING THE MOTOR

This unit features a unique safety system that prevents damage to the motor and drive system should you inadvertently overload it. If the unit is overloaded, the motor will be temporarily disabled. Should this occur, follow the reset procedure below.

**1** Unplug the unit from the electrical outlet.

**2** Allow the unit to cool for approximately 15 minutes.

**3** Remove the container's lid and blade assembly. Empty the container and ensure no ingredients are jamming the blade assembly.

**IMPORTANT:** Ensure that maximum capacities are not exceeded. This is the most typical cause of appliance overload.

## TROUBLESHOOTING GUIDE

**WARNING:** To reduce the risk of shock and unintended operation, turn power off and unplug unit before troubleshooting.

**Display reads "--".**

If the display reads "--", install a container and the available program buttons will illuminate, indicating the unit is ready for use. Ensure the lid is fully engaged and the container has been rotated clockwise and clicked to lock into place.

If vessel is properly installed and the display reads "--", ensure the interior of the base area is clean of any debris.

**Display reads "E1".**

If the display reads "E1", unplug the unit from the electrical outlet and allow it to cool for 15 minutes. Remove the blade assembly and empty the contents to ensure no ingredients are jamming the blade assembly.

**Display reads "E2".**

If the display reads "E2", unplug the unit from the electrical outlet and allow it to cool for 5 minutes. Remove the blade assembly and empty the contents to ensure no ingredients are jamming the blade assembly. If output is too thick and ingredients are not processing properly, add more liquid.

**Blade speed sometimes changes when blending thinner ingredients.**

When using speed 9 or 10 with the Pitcher, you may notice a change in the blade speed when blending thinner ingredients. This is due to the smart technology in the blender and is part of the unit's normal operation.

**Unit doesn't mix well; ingredients get stuck.**

Using the Auto-iQ® programs is the easiest way to achieve great results. The pulses and pauses allow the ingredients to settle toward the blade assembly. If ingredients are routinely getting stuck, adding some liquid will usually help.

When filling the cup, start with fresh fruit or veggies, then leafy greens or herbs. Next add liquids or yogurt, then seeds, powders, or nut butters. Finally, add ice or frozen ingredients.

If using the Smoothie Bowl Maker, during the blending process twist the built-in tamper counterclockwise continuously to circulate ingredients.

**Unit moves on counter while blending.**

Make sure the surface and feet of the unit are clean and dry.

**Preset program will not work.**

The unit can detect which container is on the motor base. You may be trying to use a program that is not designed for the container you have installed. The programs will light up, indicating which programs are available for each container.

**Food is not evenly chopped.**

For best results when chopping, cut pieces of ingredients in a uniform size and don't overfill the Pitcher.

**Can't remove the built-in tamper from the Smoothie Bowl Maker.**

The built-in tamper in the Smoothie Bowl Maker is not removable. For cleaning instructions, refer to the Care & Maintenance section.

**Can only select speed 10 in Manual Mode when using the Smoothie Bowl Maker or single-serve cup.**

Only speed 10 is available when using the Smoothie Bowl Maker or single-serve cup. All 10 speeds ranges are available when using the Pitcher and Stacked Blade Assembly. **IMPORTANT:** Only use speeds 1 or 2 when using the Dough Blade Assembly.

Note: The Quick Guide shows the select accessories that are included with your model.

## WARRANTY REPAIR INFORMATION

If you need service on your unit and this product requires repair during the 90 days warranty period; please go to [www.ConsumerServiceRefurbish.com](http://www.ConsumerServiceRefurbish.com) or call the **Refurbished Product Service Center** at 562-946-3531 to obtain the required return authorization (RA) number. Pack the unit properly (the original carton is ideal for this purpose) along with a copy of your purchase receipt and a letter describing the problem. Send the unit freight prepaid and insured to:

**Refurbished Product Service Center,**

Att: Customer Service Department 13225 Marquardt Avenue Santa Fe Springs, CA 90670

Your unit will be promptly repaired and returned to you.

We will refuse to accept delivery of the returned unit unless the assigned RA number appears on the outside of the shipping carton.

**Owner's Information**

(Keep for your permanent records)

NAME: \_\_\_\_\_

ADDRESS: \_\_\_\_\_

CITY: \_\_\_\_\_ STATE: \_\_\_\_\_ ZIP CODE: \_\_\_\_\_

PHONE: \_\_\_\_\_ E-MAIL: \_\_\_\_\_

MODEL: \_\_\_\_\_ SERIAL NO.: \_\_\_\_\_

## TECHNICAL SPECIFICATIONS

Voltage: 120V~, 60Hz

804106834



PRINTED IN MEXICO / SC: 01-07-2022 TAB / Elbrd:J.E.  
OBPN: SS350\_IB\_MP\_Mv7\_210623 / SHNMDL: SS350\_B