

Shark

814100087

DuoClean® PowerFins® HairPro™ Lift-Away® with Self-Cleaning Brushroll and Odor Neutralizer Technology Upright Vacuum

Please read this manual carefully before operating your unit and retain for future reference.

IMPORTANT SAFETY INSTRUCTIONS FOR HOUSEHOLD USE ONLY

WARNING

To reduce the risk of fire, electric shock, injury, or property damage, when using an electrical appliance, basic precautions should always be followed, including the following:

READ ALL INSTRUCTIONS BEFORE USING THIS VACUUM

- Inspect power cord and plug for any damage before use. **DO NOT** use vacuum cleaner with a damaged cord or plug. Turn off all controls before plugging in or unplugging the vacuum cleaner. Store your vacuum cleaner with the power cord secured around the two cord hooks. To minimize the risk of power cord damage, do not allow the motorized brush roll to ingest the cord. If this occurs, immediately shut off power to the vacuum and remove the cord.
- This appliance has a polarized plug. If the plug does not fit fully into the outlet, reverse the plug (one blade is wider than the other). If it still does not fit, contact a qualified electrician. **DO NOT** force into outlet or try to modify to fit.
- Your vacuum cleaner may consist of a motorized nozzle, wand, hose, and/or vacuum pod. This device contains electrical connections, electrical wiring, and moving parts that potentially present risk to the user. The hose contains electrical wires. Do not use when damaged, cut, or punctured.
- Use only identical replacement parts.
- Carefully observe and follow the instructions provided below to avoid improper use of the appliance. **DO NOT** use the vacuum for any purpose other than those described in this manual.
- Before use, carefully inspect all parts for any damage. **DO NOT** use if any parts are damaged.
- The use of an extension cord is **NOT** recommended.
- This vacuum cleaner contains no serviceable parts.
- This appliance can be used by persons with reduced physical, sensory, or mental capabilities or lack of experience and knowledge if they have been given supervision or instruction concerning use of the appliance in a safe way and understand the hazards involved. Cleaning and user maintenance shall not be made by children. Keep the appliance and its cord out of reach of children. **DO NOT** allow the appliance to be used as a toy. Close supervision is necessary when used near children.
- Always turn off the vacuum cleaner before connecting or disconnecting any motorized nozzles, hose, or other accessories.
- DO NOT** handle plug or vacuum cleaner with wet hands.
- DO NOT** use without filters in place.
- Only use Shark® branded filters and accessories.
- DO NOT** damage the power cord:
 - DO NOT** pull or carry vacuum cleaner by the cord or use the cord as a handle.
 - DO NOT** unplug by pulling on cord. Grasp the plug, not the cord.
 - DO NOT** run the vacuum cleaner over the power cord, close a door on the cord, pull the cord around sharp corners, or leave the cord near heated surfaces.
- DO NOT** put any objects into nozzle or accessory openings. **DO NOT** use with any opening blocked; keep free of dust, lint, hair, and anything that may reduce airflow.
- DO NOT** use if nozzle or accessory airflow is restricted. If the air paths or the motorized floor nozzle become blocked, turn the vacuum cleaner off and unplug from electrical outlet. Remove all obstructions before you plug in and turn on the unit again.
- Keep nozzle and all vacuum openings away from hair, face, fingers, uncovered feet, or loose clothing.
- DO NOT** use if vacuum cleaner is not working as it should, or has been dropped, damaged, left outdoors, or dropped into water.
- Use extra care when cleaning on stairs.
- DO NOT** leave the vacuum cleaner unattended while plugged in.
- When powered on, keep the vacuum cleaner moving over the carpet surface at all times to avoid damaging the carpet fibers.
- DO NOT** place vacuum cleaner on unstable surfaces such as chairs or tables.
- Your Shark® vacuum may not be designed to stand up on its own. When taking a break from cleaning, you may need to lean it against furniture or a wall, or lay it flat on the floor. Using the vacuum for an application where the unit lacks stability may result in personal injury.
- DO NOT** use to pick up:
 - Liquids
 - Large objects
 - Hard or sharp objects (glass, nails, screws, or coins)
 - Large quantities of dust (drywall dust, fireplace ash, or embers). **DO NOT** use as an attachment to power tools for dust collection.
 - Smoking or burning objects (hot coals, cigarette butts, or matches)
 - Flammable or combustible materials (lighter fluid, gasoline, or kerosene)
 - Toxic materials (chlorine bleach, ammonia, or drain cleaner)
- DO NOT** use in the following areas:
 - Poorly lit areas
 - Wet or damp surfaces
 - Outdoor areas
 - Spaces that are enclosed and may contain explosive or toxic fumes or vapors (lighter fluid, gasoline, kerosene, paint, paint thinners, mothproofing substances, or flammable dust).
- Turn off all controls before plugging in or unplugging the vacuum.

ODOR

- Observe the following when interacting with the odor neutralizer technology cartridge:
 - DO NOT** attempt to disassemble odor neutralizer technology cartridge.
 - Avoid direct contact with the fragrance pod in the cartridge.
 - DO NOT** directly inhale from the odor neutralizer technology cartridge

- Keep away from children and pets.
 - Keep away from heat, sparks, and open flame.
 - DO NOT** place in direct sunlight.
- FRAGRANCE CARTRIDGE FIRST AID**
- Avoid contact with fabrics and finished surfaces.
 - Eye contact: Remove contact lenses if present. Rinse continuously with water for several minutes.
 - Skin contact: Wash hands thoroughly after handling. If irritation or rash develops, seek medical advice/attention.
 - Inhalation: Move person to fresh air if they are experiencing any respiratory symptoms. If symptoms persist, seek medical advice/attention.
 - Ingestion: **DO NOT** induce vomiting. Seek medical advice/attention.
- Unplug from electrical outlet when not in use and before any maintenance or cleaning.
 - Hand wash with water only. Washing with cleaning chemicals could damage the unit.
 - During cleaning or routine maintenance, **DO NOT** cut anything other than hair, fibers, or string wrapped around the brushroll.
 - Allow all filters to air-dry completely before replacing in the vacuum to prevent liquid from being drawn into electric parts.
 - Make sure the dust cup and all filters are in place after routine maintenance.
 - If provided, secure the power cord around the two cord hooks during storage.

SAVE THESE INSTRUCTIONS

ASSEMBLY

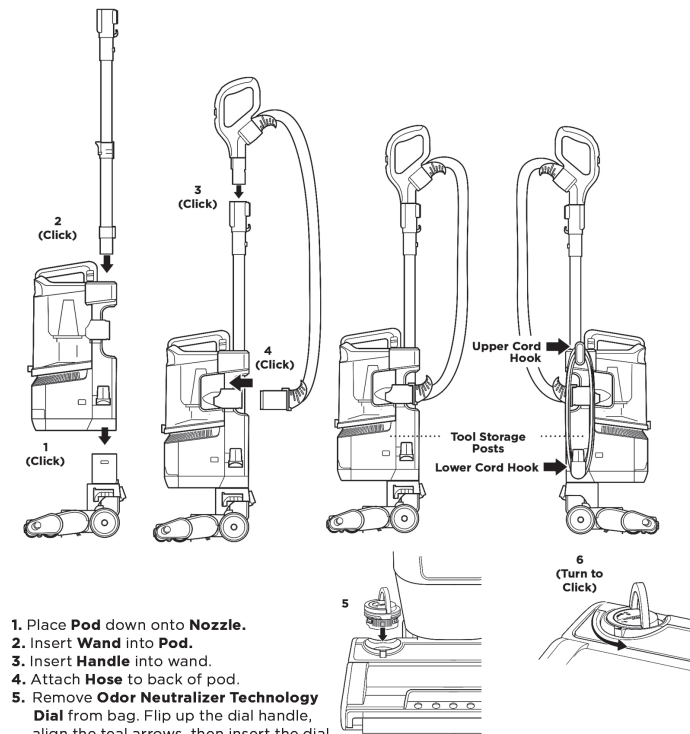

- Place Pod down onto Nozzle.
- Insert Wand into Pod.
- Insert Handle into wand.
- Attach Hose to back of pod.
- Remove Odor Neutralizer Technology Dial from bag. Flip up the dial handle, align the teal arrows, then insert the dial into the nozzle.
- To lock and engage the dial, rotate it counterclockwise until it clicks into the desired odor intensity setting.

* More detailed odor neutralizer technology assembly instructions and visuals.

IMPORTANT: For proper operation, ensure all connections are securely clicked into place.

NOTE: Accessories may vary depending on the model.

The images shown here are for illustrative purposes only and may be subject to change.

POWER CORD

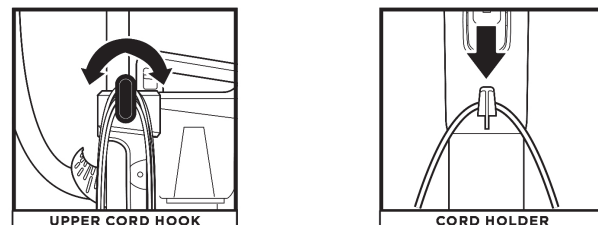

For cord access, rotate upper hook down and remove cord.

Use cord holder on the side of wand to hold cord in place while vacuuming.

TECHNOLOGY SETTINGS

SETTINGS

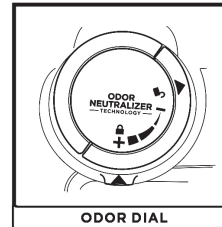

ODOR DIAL

Flip up the dial handle and rotate the odor dial to align the teal arrows. Remove the dial to access the odor cartridge for removal or replacement.

Low: Rotate the dial toward the Low position to decrease the intensity to the lowest level when the vacuum is in use.

High: Rotate the dial toward the High position for the highest intensity level when the vacuum is in use. This position is the recommended setting for optimal performance.

ODOR NEUTRALIZER TECHNOLOGY TIPS

Odor Dial Must be Installed for Vacuum to Function Properly

- Remove odor cartridge from dial if you don't want the benefits of the odor neutralization technology.

Maintenance Required

- Clean all filters as recommended under Cleaning Filters.
- Empty the dust cup before storing your vacuum.
- Replace the cartridge as recommended under Odor Cartridge Replacement.
- Visit qr.sharkclean.com/odortech to learn more and purchase replacements.
- If wet pet messes are cleaned up, thoroughly clean the vacuum.

Fragrance Strength Over Time

- The intensity of the odor neutralizer technology's fragrance may diminish over time. It may also have no noticeable fragrance at all. This is natural and does not indicate the technology isn't working. Follow replacement instructions to ensure continued performance.

NOTES: • The odor dial needs to be installed for the vacuum to function properly, with or without the odor cartridge.
• Odor Neutralizer technology effectively deodorizes while interacting with odors from inanimate sources.

ODOR NEUTRALIZER TECHNOLOGY

ODOR CARTRIDGE REPLACEMENT



1. REMOVE ODOR DIAL FROM NOZZLE

Flip up the handle and rotate the dial clockwise until the two teal arrows are aligned. Pull the handle to remove the dial from the nozzle.

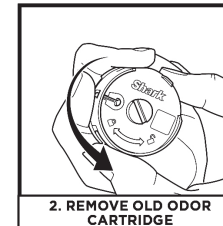

2. REMOVE OLD ODOR CARTRIDGE

Rotate the cartridge counterclockwise in the dial housing and pull out the cartridge to remove it.

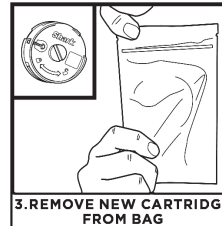

3. REMOVE NEW CARTRIDGE FROM BAG

Remove the new odor cartridge from the sealed packaging. To maintain the life of the cartridge, keep it in the sealed packaging until you are ready to install it.

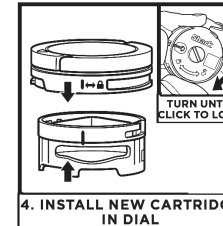

4. INSTALL NEW CARTRIDGE IN DIAL

Align the yellow arrow on the side of the cartridge with the yellow arrow on the side of the dial cover, then insert the cartridge into the dial. Rotate the cartridge clockwise to lock it in place.

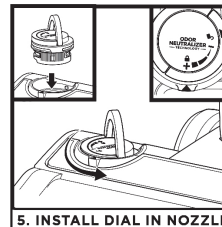

5. INSTALL DIAL IN NOZZLE

Align the teal arrow on the dial cover with the teal arrow on the nozzle, then reinsert the dial into the nozzle. Rotate the dial counterclockwise until it clicks into an intensity setting to engage. Rotate further to change the intensity setting.

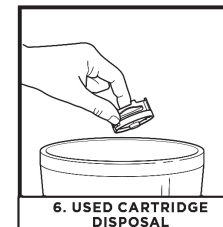

6. USED CARTRIDGE DISPOSAL

Dispose of the old cartridge by dropping it into the trash.

NOTE: Odor cartridges should be replaced every 6 months for optimal odor neutralizer technology performance.

WHOLE-HOME CLEANING

SETTINGS

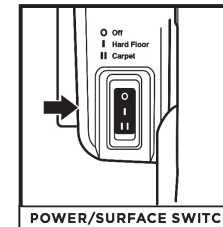

POWER/SURFACE SWITCH

Select surface setting:

Power Off

I Hard Floor

For hard floors and small area rugs.

II Carpet

For carpets.

NOTE: For deep carpet cleaning per ASTM F608, use setting II (Carpet) with MAX suction.

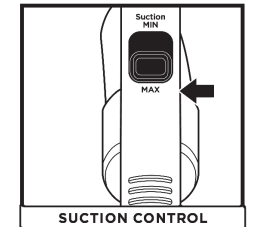

SUCTION CONTROL

The Suction Control Slider located on the handle allows you to adjust the suction depending on the floor type.

MIN: to reduce suction and increase maneuverability on carpets.
MAX: to increase suction on hard floors.

NOTE: The brushrolls spin in all modes

HEADLIGHT INDICATOR LIGHTS

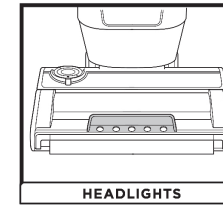

HEADLIGHTS

The headlights will flash or turn red to indicate issues that need attention.

Solid White Lights: The brushrolls are spinning and the unit is working as it should.
Solid Red Lights: There is a jam in the brushroll area. Turn off the vacuum and unplug it, then remove any blockages in the nozzle.

Flashing Red Lights: The motorized floor nozzle is overheating. Turn off the vacuum, unplug it, and remove any blockages. Let the vacuum cool down for at least 60 minutes before restarting. See Troubleshooting section for more information.

Flashing White Lights: The vacuum is operating in an environment that is either too hot or too cold. This vacuum will only function properly in temperatures ranging from 32°F (0°C) to 104°F (40°C). Turn the vacuum off and adjust the room temperature.

NOTE: For deep cleaning per ASTM F608 (embedded dirt in carpets), please set to Carpet mode.
NOTE: For maximum suction for above-floor cleaning per ASTM F558, set to Hard Floor mode.

CLEANING MODES

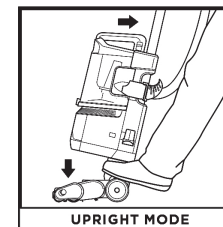

UPRIGHT MODE

To engage Brushrolls, select a surface setting, step on floor nozzle and tilt handle back firmly.

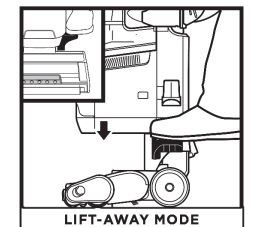

LIFT-AWAY MODE

Step on the pedal on the floor nozzle to lift off the pod.

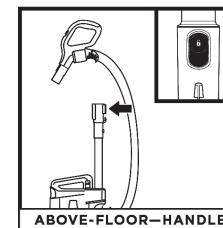

ABOVE-FLOOR—HANDLE

Press the Handle Release button and pull up on the handle to detach it from the wand.

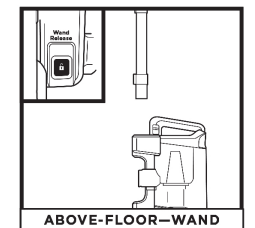

ABOVE-FLOOR—WAND

Press the Wand Release button and pull up on the wand to detach it from the pod.

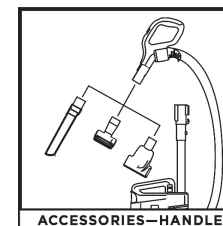

ACCESSORIES—HANDLE

Attach an optional cleaning accessory to handle or wand.

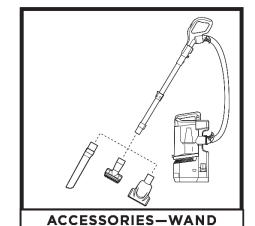

ACCESSORIES—WAND

NOTE: All accessories are compatible with both the wand and the handle. Included accessories will vary by model.

EMPTYING THE DUST CUP

IMPORTANT: Unplug the power cord before performing any maintenance. Empty the dust cup each time you vacuum and periodically during cleaning, when debris in the dust cup reaches the MAX fill line.

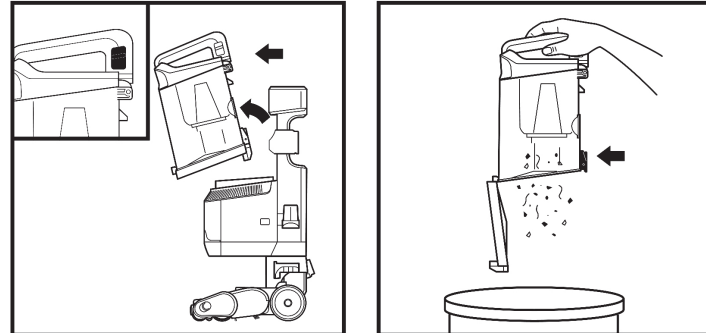

To remove the **Dust Cup**, slide up on the release button located on the side of dust cup handle. Tilt dust cup forward, then lift to remove.

To empty debris into the trash, press the lower release button and the bottom of the dust cup will drop open.

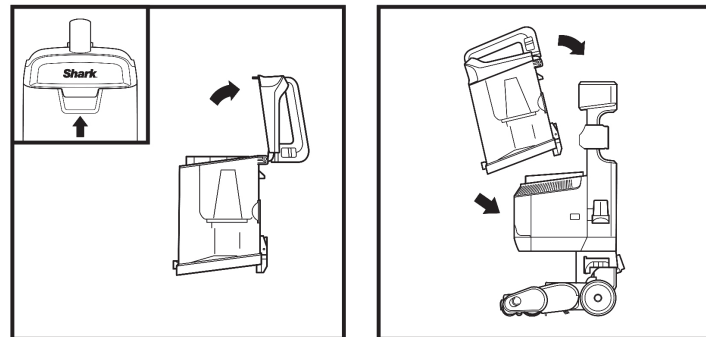

Clear debris from the **Lint Screen** in the dust cup. Lift the upper release tab at the top of the dust cup and open the lid. Gently brush the lint screen to remove debris.

To reinstall, place the bottom of the dust cup onto the pod and then tilt until it clicks into place.

CLEANING THE FILTERS

Regularly rinse and replace the filters to maintain your vacuum's suction power and to maximize the effectiveness of the odor neutralizer technology.

Rinse filters with cold water only. Allow all filters to air-dry for at least 24 hours before reinstalling them to prevent liquid from being drawn into electronic parts.

IMPORTANT: DO NOT use soap when cleaning the filters.

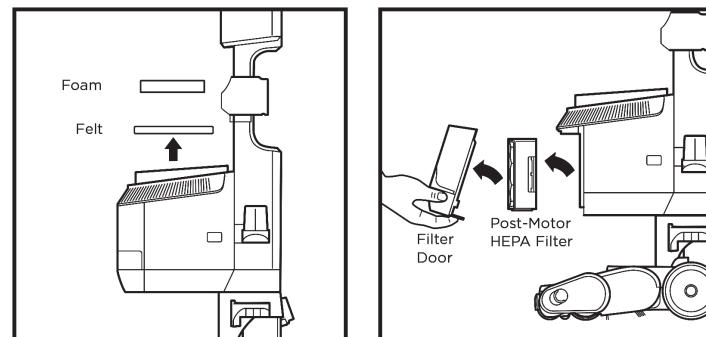

RINSE PRE-MOTOR FILTERS EVERY MONTH

Remove the **Dust Cup**, then lift out **Filters**.

RINSE HEPA FILTER EVERY YEAR

To remove the **HEPA Filter**, first pull the tab on the bottom of the filter door, then lift off the door. Press the tab on the side of the HEPA filter and pull out the filter. To reinstall the door, align the top first, then press in the bottom until it clicks into place.

MAINTENANCE

NOZZLE MAINTENANCE

SELF-CLEANING BRUSHROLL

If any hair is wrapped around the brushroll, continue vacuuming, using Carpet/Low Pile mode on a bare floor surface, a low-pile carpet, or a small area rug. This will allow the self-cleaning brushroll to remove the hair wrap and send it to the dust cup.

If you run over a hard or sharp object or notice a noise change while vacuuming, check for blockages or objects caught in the brushroll.

If some fibers remain wrapped around the brushroll after continued use, carefully remove them.

CLEANING THE SOFT ROLLER

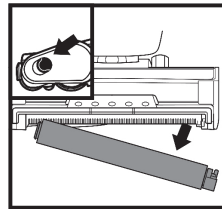

Slide the Soft Roller access button forward to release the Soft Roller.

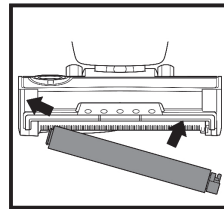

Hand wash the Soft Roller as needed. Use only water, and allow it to air-dry completely for at least 24 hours. Reinsert the Soft Roller in the front of the nozzle until it clicks into place.

CORD MAINTENANCE

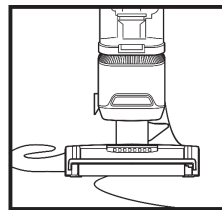

- DO NOT** pull or carry vacuum cleaner by the cord or use cord as a handle.
- DO NOT** unplug by pulling on the cord. Grasp the plug, not the cord.
- DO NOT** close the door on the cord.
- DO NOT** pull the cord around sharp corners.
- DO NOT** leave the cord near heated surfaces.

To minimize the risk of power cord damage, **DO NOT** run the vacuum over the power cord. If this occurs, immediately shut off power to the vacuum and remove the cord from the brushrolls or nozzle.

CHECKING FOR BLOCKAGES

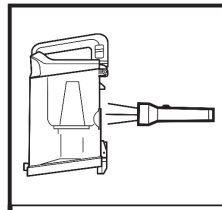

DUST CUP BLOCKAGES

Detach dust cup from vacuum pod. Empty dust cup and remove debris from lint screen in the top of the dust cup.

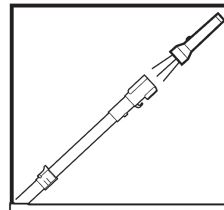

WAND BLOCKAGES

Detach wand from pod and handle, and check both ends for blockages.

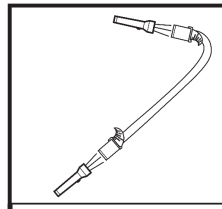

HOSE BLOCKAGES

Detach hose from handle by pressing on the release button at the top of the hose. Detach the hose from the pod, and check openings for blockages.

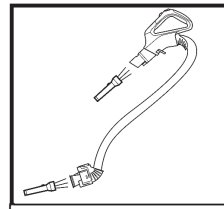

HANDLE/HOSE BLOCKAGE

Detach handle from wand and hose from the vacuum pod, and check openings for blockages.

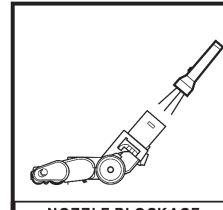

NOZZLE BLOCKAGE

Detach wand from floor nozzle, tilt nozzle neck back, and check opening for blockages.

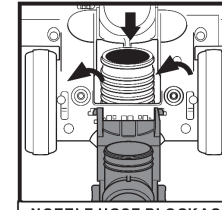

NOZZLE HOSE BLOCKAGE

To access the nozzle hose, pinch the release touchpoints on the bottom of the nozzle, then lift the cover and clear any blockages.

TROUBLESHOOTING

Power cord caught in brushrolls or floor nozzle.

- To minimize the risk of power cord damage, **DO NOT** run the vacuum over the power cord. If this occurs, immediately shut off power to the vacuum and remove the cord from the brushrolls or nozzle.
- Inspect power cord and plug for any damage before use. **DO NOT** use vacuum cleaner with a damaged cord or plug. Turn off all controls before plugging in or unplugging the vacuum cleaner. Store your vacuum cleaner with the power cord secured around the two cord hooks.

Vacuum is not picking up debris. No suction or light suction.

- Check filters to see if they need cleaning. Follow instructions for rinsing and air-drying the filters before reinstalling them in the vacuum.
- Dust cup may be full; empty dust cup.
- Check handle, hose, hose connections, nozzle, wand, pod, and accessories for blockages. Clear any blockages found.
- If any string, hair, or carpet fibers are wrapped around the PowerFins® brushroll, carefully cut debris with scissors and remove from brushroll. See Nozzle Maintenance section for more information.

Vacuum lifts area rugs.

- Make sure Power/Surface switch is set to Hard Floor (setting I).
- Ensure the suction control slider on the handle is set to MIN.
- Suction is powerful. Take care when vacuuming area rugs or rugs with delicately sewn edges.

Brushrolls do not spin in carpet cleaning mode.

- If the headlight indicator light turns red, immediately turn off and unplug the vacuum. Remove pod from floor nozzle and clear any blockages. Reconnect nozzle, plug in vacuum, and turn on power.
- With the power on, recline the handle, which will automatically turn on the brushrolls.
- If this problem persists on thick carpets, move the suction control slider to MIN.

Vacuum turns off on its own or headlight indicator lights flash red.

If your vacuum overheats, the thermostat will automatically turn off the motor. Perform the following steps to restart:

- Turn vacuum off and unplug it.
- Empty dust cup and clean filters. See Emptying the Dust Cup and Cleaning and Replacing the Filters sections for more information.
- Check for blockages in hose, wand, floor nozzle, accessories, and inlet openings.
- Allow unit to cool for a minimum of 60 minutes.
- Plug in vacuum and turn it on.

Vacuum is emitting air that smells bad.

- Dust cup may be full; empty dust cup. Empty dust cup after each use for optimal odor neutralizer technology performance.
- Check filters to see if they need cleaning. Follow instructions for rinsing and air-drying the filters before reinstalling them.
- Check to make sure odor cartridge is installed in the dial and the dial is installed in the nozzle.
- Check the odor neutralizer technology dial on the nozzle to see what setting is enabled.
- If odor neutralizer technology dial is at any setting from Low to High and the cartridge has been installed for 6 months or longer, consider replacing it.
- If the odor cartridge is still emitting a scent but you dislike it, consider turning the intensity down, or reinstall the dial in the nozzle without the cartridge.
- If the odor neutralizer technology cartridge is not emitting a scent, consider replacing it.

For all other issues, please contact a service center.

TECHNICAL SPECIFICATIONS

Voltage: 120V~, 60Hz

ODOR NEUTRALIZER TECHNOLOGY SPECIFICATIONS

- Product Name: Odor Neutralizer Technology Cartridge
- Manufacturer: Shark Ninja 89 A Street Needham, MA 02494
- Weight: 17.6g / 0.62oz
- Ingredients: Solid SM composite polymer C17 + fragrance SE 272235

REFURBISHED PRODUCT LIMITED NINETY DAYS WARRANTY

The **Refurbished Product Service Center** offers the following WARRANTY to the ORIGINAL purchaser of a product which we have refurbished.

This product that has been refurbished is warranted against any electronic or mechanical defects for a period of NINETY DAYS from the date of the original purchase by the consumer. Since this unit was sold as a refurbished item, the warranty does not apply to any cosmetic appearance items such as scratches. Should a defect occur, the **Refurbished Product Service Center** will repair or, at its option, replace defective unit/parts with new or rebuilt materials without charge for either parts or labor. Replacement unit/parts will be warranted for the remaining portion of the original warranty period.

This warranty does not cover installation or damage from accident, misuse, abuse, improper wiring, incorrect voltage, operating the unit against the instructions in the owner's manual or any product which has been opened, altered, or tampered with.

This warranty does not cover costs for removal and or installation of the unit for repair. Under no circumstances shall the service center be liable for any special, incidental or consequential damages or for any other expenses incurred by reason of use or sale of this product. This warranty is in lieu of any other warranties expressed or implied warranty of merchantability of fitness for particular use or otherwise.

This warranty gives the consumer specific legal rights and they may also have other rights which vary from State to State. Some States do not follow the exclusion or limitation of incidental or consequential damages, hence the above exclusion and limitations may not apply.

Refurbished Product Service Center
13225 Marquardt Avenue Santa Fe Springs, CA 90670.

WARRANTY REPAIR INFORMATION

If you need service on your unit and this product requires repair during the 90 days warranty period; please go to www.ConsumerServiceRefurbish.com or call the **Refurbished Product Service Center** at 562-946-3531 to obtain the required return authorization (RA) number. Pack the unit properly (the original carton is ideal for this purpose) along with a copy of your purchase receipt and a letter describing the problem. Send the unit freight prepaid and insured to:

Refurbished Product Service Center,
Att: Customer Service Department 13225 Marquardt Avenue Santa Fe Springs, CA 90670

Your unit will be promptly repaired and returned to you.

We will refuse to accept delivery of the returned unit unless the assigned RA number appears on the outside of the shipping carton.

Owner's Information
(Keep for your permanent records)

NAME: _____

ADDRESS: _____

CITY: _____ STATE: _____ ZIP CODE: _____

PHONE: _____ E-MAIL: _____

MODEL: _____ SERIAL NO.: _____

PLEASE READ CAREFULLY AND KEEP FOR FUTURE REFERENCE.

This Owner's Guide is designed to help you get a complete understanding of your new Shark® DuoClean® PowerFins® HairPro™ Lift-Away® with Self-Cleaning Brushroll and Odor Neutralizer Technology Upright Vacuum.

SharkNinja Operating LLC

Illustrations may differ from actual product. We are constantly striving to improve our products; therefore the specifications contained herein are subject to change without notice.

This product may be covered by one or more U.S. patents. See sharkninja.com/patents for more information.

© 2022 SharkNinja Operating LLC. DUOCLEAN, LIFT-AWAY, POWERFINS, and SHARK are registered trademarks of SharkNinja Operating LLC. HAIRPRO is a trademark of SharkNinja Operating LLC.

NOTE: The image shown here is for illustrative purposes only and may be subject to change.

PRINTED IN MEXICO / SC.29-06-2023

OBPN: UV900Series_IB_REV_Mv2_221128

Elabrd:J.E / TAB / SHNMDL: UV900_B

814100087



QUICK START GUIDE

Please be sure to read the enclosed Shark® Owner's Guide prior to using your unit.

WHAT'S INSIDE

- (A)** Handle & Hose
- (B)** Wand
- (C)** Vacuum Pod
- (D)** Anti-Allergen Dust Brush
- (E)** Odor Neutralizer Technology Cartridge
- (F)** Pet Crevice Tool
- (G)** Pet Multi-Tool
- (H)** HairPro™ Self-Cleaning Pet Power Brush

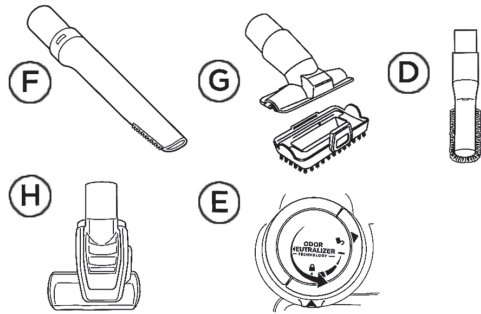

NOTE: Accessories may vary depending on the model.

The images shown here are for illustrative purposes only and may be subject to change.

PRINTED IN MEXICO Elbrd: J.E.
 OBPN: N/A
 SC: 07-10-2023_1P MODEL: UV900_B

 814000087

ASSEMBLY

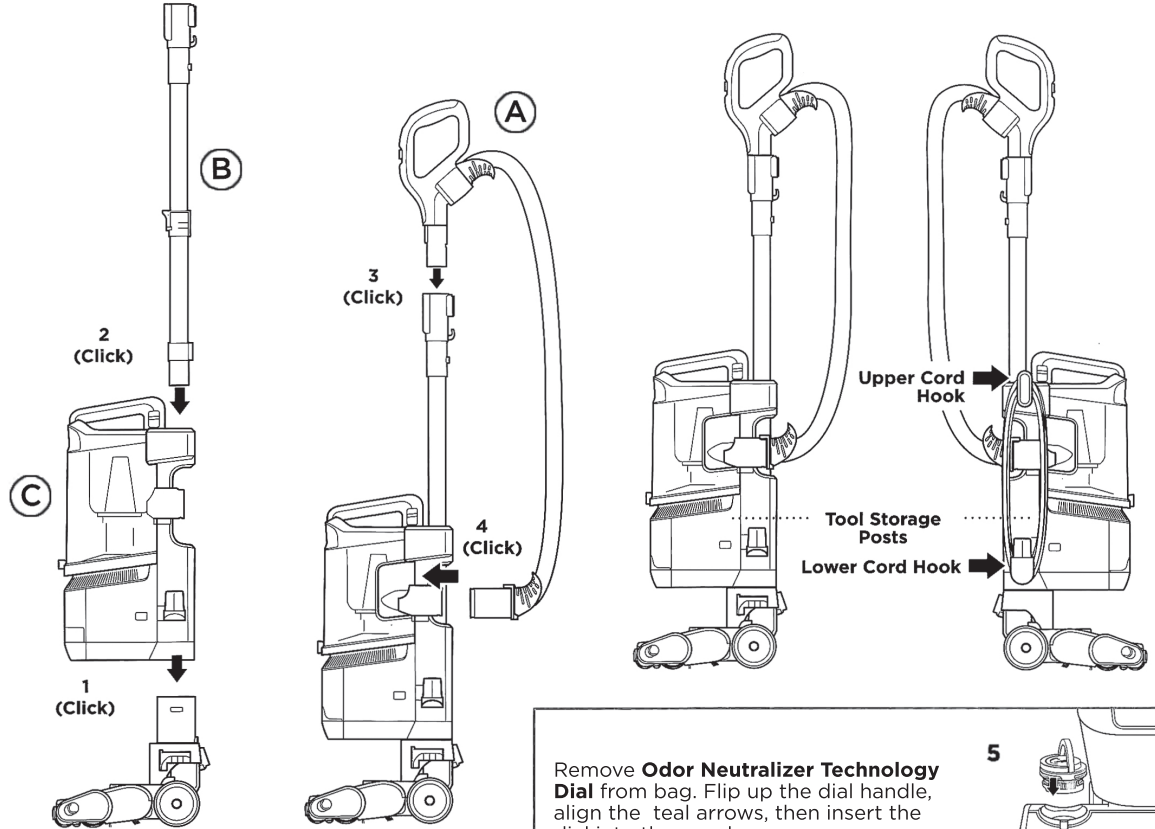

1. Place **Pod** down onto **Nozzle**.
2. Insert **Wand** into **Pod**.
3. Insert **Handle** into wand.
4. Attach **Hose** to back of pod.

Remove **Odor Neutralizer Technology Dial** from bag. Flip up the dial handle, align the teal arrows, then insert the dial into the nozzle.

To lock and engage the dial, rotate it counterclockwise until it clicks into the desired odor intensity setting.