

VIZIO | Quick Setup Guide

Scan for an Easy Setup.

Important!

Do not touch screen.

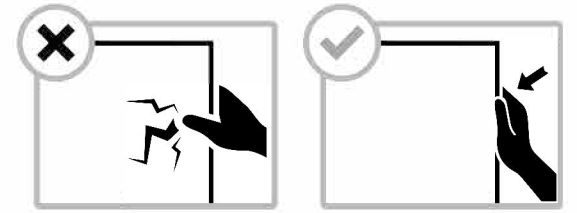

What's Inside the Box

Smart TV | Power Cable | Voice Remote | TV Feet with Screws

1

Place TV on a padded, flat surface that is larger than the TV, before installing feet* or wallmount (not included). When the stand legs are properly connected, the legs will not shift or move.

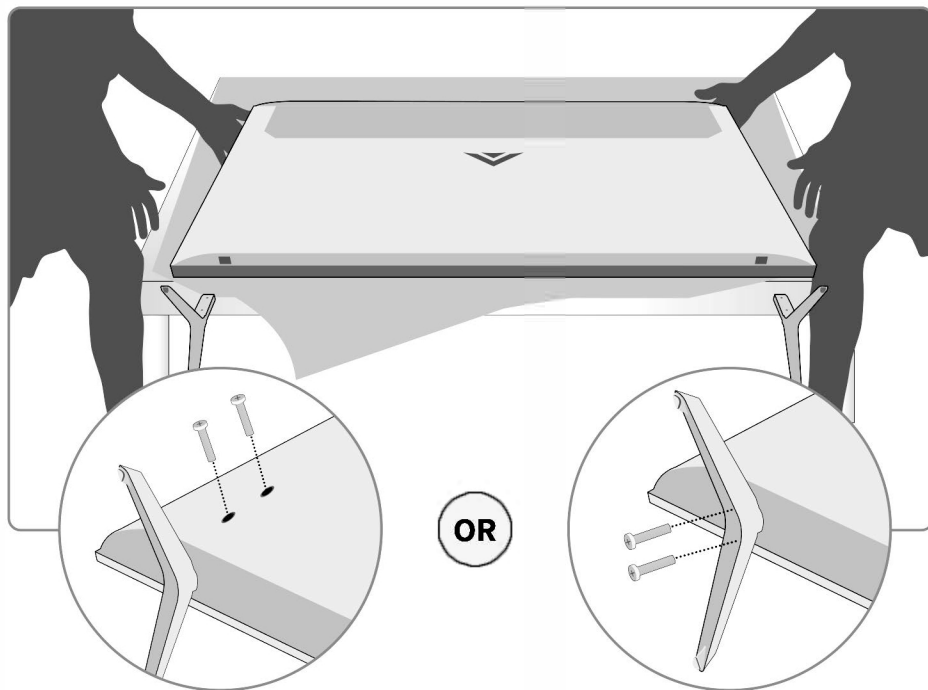

*Stand type may vary depending on model.

2

Plug the TV power cord into a wall outlet. Connect your other devices to the TV, such as game console (not included). HDMI cable is recommended.

Adapters may be required and are not included.

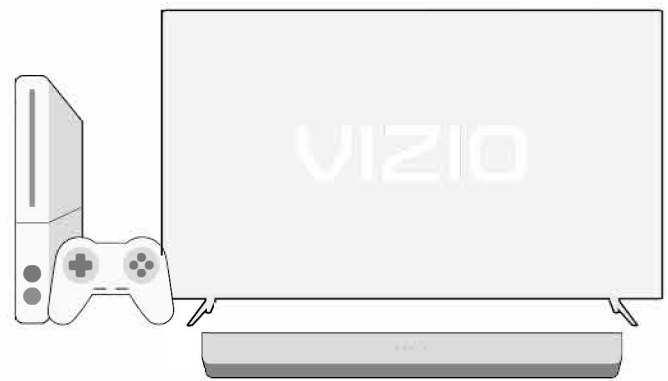

Why HDMI?

Highest Quality Connection:

Connect your devices with HDMI for the best possible picture and sound.



HDMI

Dedicated Sound Bar Connection: Connect a sound bar to the HDMI 1 (eARC) port on the TV (marked in green).



HDMI 1 (eARC)

Integrated Sound Bar Control:

When connected to select VIZIO sound bars using HDMI, audio settings may be adjusted easily via an onscreen menu.

3

Insert two AAA batteries into the remote control. Aim directly at the TV and press the power button.

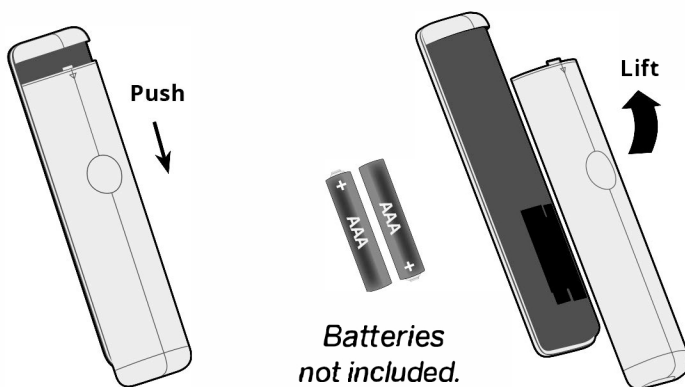

Batteries not included.

The remote control vary depend of model: The buttons on the remote control may have a different name or location than the remote control shows in this manual.

The image shown here is for illustrative purposes only and may be subject to change.



4

Follow the easy on-screen instructions to complete your setup and enjoy!

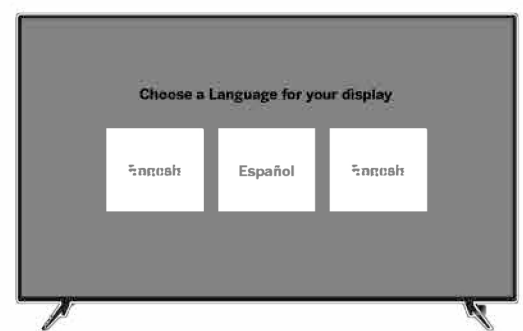

Want the best viewing experience?

Select a **Picture Mode setting** that best fits your room & lighting.

805001353



PRINTED IN MEXICO / SC:08-10-2023 / Elbrd:J.E.
OBPN:90111-22061 / SHNMDL: V655MK04

VIZIO

V-Series User Manual

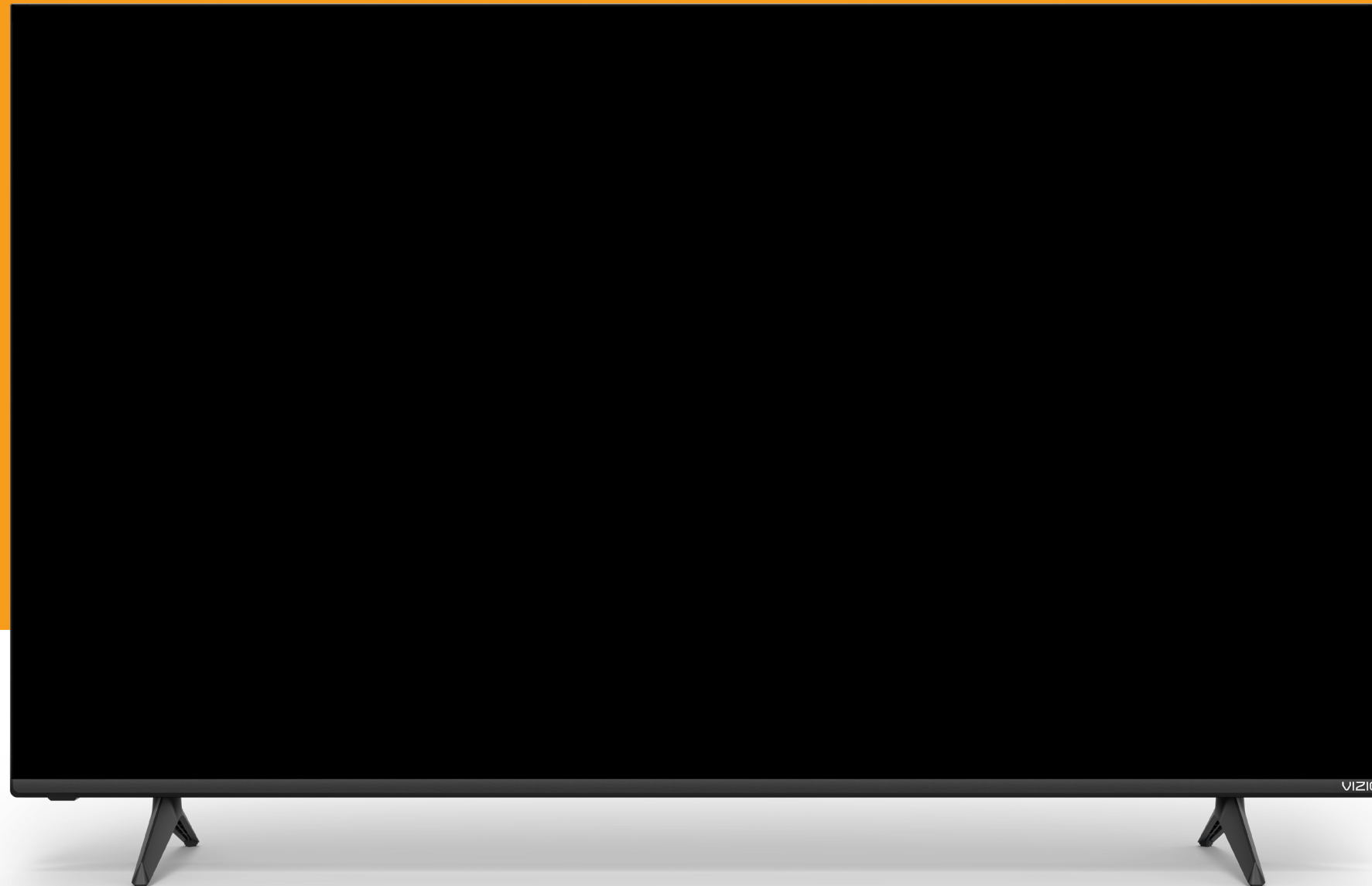

Models:

V435M-K04, V505M-K09, V555M-K01,
V585M-K01, V655M-K03, V655M-K04,
V705M-K03 & V755M-K03

Table of Contents

Getting to Know Your TV	7	Changing the On-Screen Menu Language	28	WatchFree+	36
Front Panel	7	Setting the Time	28	What is WatchFree+?	36
Power/Input Button	7	Changing the TV Name	29	What you can do with WatchFree+	36
Rear Panel	8	Renaming Devices on the Input Menu	29	How to Launch WatchFree+	36
Wall-mounting the TV	10	Adjusting the Power Mode	29	Playing USB Media	37
Using the Remote	11	Using the USB Power Feature	30	Preparing Your USB Drive to Play USB Media	37
Using Voice Control	12	Turning the Power Indicator On or Off	30	Displaying USB Media	37
Completing the First-Time Setup	13	Setting Timers	30	Removing the USB Drive from the TV	37
Using the On-Screen Menu	14	Setting a System PIN Code	31	Help Topics	41
Changing the Input Source	14	Adjusting the CEC Settings	31	Specifications	42
Navigating the On-Screen Menu	14	Managing Mobile Devices	31	Regulatory Information	44
Pairing Bluetooth headphones	14	Pairing the VIZIO Voice Remote	31	Legal Information	46
Adjusting the Picture Settings	15	Using the Admin & Privacy Menu	32		
Adjusting the Color Temperature	15	Performing a Reboot	32		
Changing the Picture Aspect Ratio	16	Viewing System Information	32		
Adjusting Advanced Picture Settings	16	Accessing the Support Code	32		
Adjusting Picture Input Settings	19	Checking for System Updates	32		
Adjusting the Picture Mode Edit Settings	19	Restoring the TV to Factory Default Settings	32		
Adjusting the Audio Settings	21	Viewing Data	33		
Sound Bar settings	21	Managing Advertising Settings	33		
Adjusting the Network Settings	22	View VIZIO Privacy Policy	33		
Setting Up TV Channels	23	Store Demo	33		
Scanning for TV Channels	23	Using the Info Window	34		
Skipping Channels	23	VIZIO Smart TV Platform	35		
Changing the Analog Audio Language	24	What is the VIZIO Smart TV Platform?	35		
Using Parental Controls	25	Launching the VIZIO Smart TV Platform	35		
Accessibility Settings	26	What you can do with the VIZIO Smart TV Platform	35		
Setting Up Closed Captioning	26	Controlling your TV with the VIZIO Mobile App	35		
Changing the Appearance of Digital Closed Captions	27				
Changing the System Settings	28				

WHEN READING THIS MANUAL



TIP: When you see this symbol, please read the accompanying helpful tip.



WARNING: When you see this symbol, please read the accompanying important warning or notice. It is intended to alert you to the presence of important operating instructions.

Color Text — This is the TV menu feature you should be selecting.

Grey Text — This is an action for you to complete, such as entering in a name.

> — The arrow sign shows the flow of the steps you should take.

1. Lists additional steps you can take for each setting.
- Bullets give more detailed information about each feature.

IMPORTANT SAFETY INSTRUCTIONS

Your TV is designed and manufactured to operate within defined design limits. Misuse may result in electric shock or fire. To prevent your TV from being damaged, the following instructions should be observed for the installation, use, and maintenance of your TV. Read the following safety instructions before operating your TV. Keep these instructions in a safe place for future reference.

- To reduce the risk of electric shock or component damage, switch off the power before connecting other components to your TV.
- Read these instructions.
- Keep these instructions.
- Heed all warnings.
- Follow all instructions.
- Do not use this apparatus near water.
- Clean only with dry cloth.
- Do not block any ventilation openings. Install in accordance with the manufacturer's instructions.
- Do not install near any heat sources such as radiators, heat registers, stoves, or other apparatus (including amplifiers) that produce heat.
- Do not defeat the safety purpose of the polarized or grounding-type plug. A polarized plug has two blades with one wider than the other.
 - A grounding type plug has two blades and a third grounding prong. The wide blade or the third prong are provided for your safety.
 - If the provided plug does not fit into your outlet, consult an electrician for replacement of the obsolete outlet.
- Protect the power cord from being walked on or pinched particularly at plugs, convenience receptacles, and the point where they exit from the apparatus.
- Only use attachments/accessories specified by the manufacturer.
- Use only with the cart, stand, tripod, bracket, or table specified by the manufacturer, or sold with the apparatus. When a cart is used, use caution when moving the cart/apparatus combination to avoid injury from tip-over.
- Some larger TVs may require two-person operation for moving and/or installing the TV.
- Refer all servicing to qualified service personnel. Servicing is required when the apparatus has been damaged in any way, such as power-supply cord or plug is damaged, liquid has been spilled or objects have fallen into the apparatus, the



apparatus has been exposed to rain or moisture, does not operate normally, or has been dropped.

- **CAUTION:** Always use a power outlet that is properly grounded.
- Unplug this TV during lightning storms or when unused for long periods of time.
- When moving your TV from an area of low temperature to an area of high temperature, condensation may form in the housing. Wait before turning on your TV to avoid causing fire, electric shock, or component damage.
- A distance of at least three feet should be maintained between your TV and any heat source, such as a radiator, heater, oven, amplifier, etc. Do not install your TV close to smoke. Operating your TV close to smoke or moisture may cause fire or electric shock.
- Slots and openings in the back and bottom of the TV are provided for ventilation. To ensure reliable operation of your TV and to protect it from overheating, be sure these openings are not blocked or covered. Do not place your TV in a bookcase or cabinet unless proper ventilation is provided.
- Never push any object into the slots and openings on your TV. Do not place any objects on the top of your TV. Doing so could short circuit parts causing a fire or electric shock. Never spill liquids on your TV.
- Your TV should be operated only from the type of power source indicated on the label. If you are not sure of the type of power supplied to your home, consult your dealer or local power company.
- Do not apply pressure or throw objects at your TV. This may compromise the integrity of the TV. The manufacturer's warranty does not cover user abuse or improper installations.
- The power cord must be replaced when using different voltage than the voltage specified. For more information, contact your dealer.
- When connected to a power outlet, power is always flowing into your TV. To totally disconnect power, unplug the power cord.
- The lightning flash with arrowhead symbol within an equilateral triangle is intended to alert the user to the presence of un-isolated, dangerous voltage within the inside of your TV that may be of sufficient magnitude to constitute a risk of electric shock to persons.
- Do not overload power strips and extension cords. Overloading can result in fire or electric shock.
- The wall socket should be installed near your TV and easily accessible.
- Only power of the marked voltage can be used for your TV. Any other voltage than the specified voltage may cause fire or electric shock.



- Do not touch the power cord during lightning. To avoid electric shock, avoid handling the power cord during electrical storms.
- Unplug your TV during a lightning storm or when it will not be used for long period of time. This will protect your TV from damage due to power surges.
- Do not attempt to repair or service your TV yourself. Opening or removing the back cover may expose you to high voltages, electric shock, and other hazards. If repair is required, contact your dealer and refer all servicing to qualified service personnel.
- **WARNING:** Keep your TV away from moisture. Do not expose your TV to rain or moisture. If water penetrates into your TV, unplug the power cord and contact your dealer. Continuous use in this case may result in fire or electric shock.
- Do not use your TV if any abnormality occurs. If any smoke or odor becomes apparent, unplug the power cord and contact your dealer immediately. Do not try to repair your TV yourself.
- Avoid using dropped or damaged appliances. If your TV is dropped and the housing is damaged, the internal components may function abnormally. Unplug the power cord immediately and contact your dealer for repair. Continued use of your TV may cause fire or electric shock.
- Do not install your TV in an area with heavy dust or high humidity. Operating your TV in environments with heavy dust or high humidity may cause fire or electric shock.
- Follow instructions for moving your TV. Ensure that the power cord and any other cables are unplugged before moving your TV.
- To prevent injury, this apparatus must be securely attached to the furniture/wall in accordance with the installation instructions.
- Insert batteries (**not supplied**) in accordance with instructions. Incorrect polarities may cause the batteries to leak which can damage the remote control or injure the operator. Do not expose batteries to excessive heat such as sunlight, fire, etc.
- When unplugging your TV, grab the head of the power plug, not the cord. Pulling on the power cord may damage the wires inside the cord and cause fire or electric shock. When your TV will not be used for an extended period of time, unplug the power cord.
- To reduce risk of electric shock, do not touch the connector with wet hands.

- Do not expose TV to liquids, including dripping or splashing.
- Do not place objects filled with liquid, such as vases, on the TV.
- **If the main wall plug or the appliance coupler is disconnected, the disconnected device will remain readily operable upon reconnection to an appropriate power source. If any of the following occurs, contact the dealer:**
 - The power cord fails or frays.
 - Liquid sprays or any object drops into your TV.
 - Your TV is exposed to rain or other moisture.
 - Your TV is dropped or damaged in any way.
 - The performance of your TV changes substantially.



- **CAUTION:** These servicing instructions are for use by qualified service personnel only. To reduce the risk of electric shock, do not perform any servicing other than that contained in the operating instructions unless you are qualified to do so.
- The lightning flash with arrowhead symbol within an equilateral triangle is intended to alert the user to the presence of uninsulated DANGEROUS VOLTAGE within the product's enclosure that may be of sufficient magnitude to constitute a risk of electrical shock to persons.
- **WARNING:** Exposure to loud sounds can damage your hearing causing hearing loss and tinnitus (ringing or buzzing in the ears). With continued exposure to loud noises, ears may become accustomed to the sound level, which may result in permanent damage to hearing without any noticeable discomfort.
- Install the TV where it cannot be pulled, pushed or knocked over.
- Do not allow children to hang onto the product.
- Store the accessories (remote, batteries, etc.) in a location safely out of the reach of children.
- The American Academy of Pediatrics discourages use of screen media for children younger than eighteen months of age.
- **WARNING — Stability Hazard:** A television set may fall, causing serious personal injury or death. Many injuries, particularly to children, can be avoided by taking simple precautions such as:

- ALWAYS use cabinets or stands or mounting methods recommended by the manufacturer of the television set.
- ALWAYS use furniture that can safely support the television set.
- ALWAYS ensure the television set is not overhanging the edge of the supporting furniture.
- ALWAYS educate children about the dangers of climbing on furniture to reach the television set or its controls.
- ALWAYS route cords and cables connected to your television so they cannot be tripped over, pulled or grabbed.
- NEVER place a television set in an unstable location.
- NEVER place the television set on tall furniture (for example, cupboards or bookcases) without anchoring both the furniture and the television set to a suitable support.
- NEVER place the television set on cloth or other materials that may be located between the television set and supporting furniture.
- NEVER place items that might tempt children to climb, such as toys and remote controls, on the top of the television or furniture on which the television is placed.
- If the existing television set is going to be retained and relocated, the same considerations as above should be applied.
- Disposal of a battery into fire or a hot oven, or mechanically crushing or cutting of a battery can result in an explosion.
- Leaving a battery in an extremely high temperature can result in an explosion or the leakage of flammable liquid or gas.
- A battery subjected to extremely low air pressure may result in an explosion or the leakage of flammable liquid or gas.
- **CAUTION:** Risk of explosion if the battery is replaced by an incorrect type.
- Use consumer grade, non-rechargeable 'AAA' carbon-zinc or alkaline batteries.
- **WARNING:** To prevent injury, this apparatus must be securely attached to the furniture/wall in accordance with the installation instructions.

TELEVISION ANTENNA CONNECTION PROTECTION

The TV shall be installed in accordance with the applicable provisions of Article 810 and Article 820.

If an outside antenna/satellite dish or cable system is to be connected to the TV, make sure that the antenna or cable system is electrically grounded to provide some protection against voltage surges and static charges.

Article 810 of the National Electrical Code, ANSI/NFPA 70, provides information with regard to proper grounding of the mast and supporting structure, grounding of the lead-in wire to an antenna discharge unit, size of the grounding conductors, location of antenna discharge unit, connection to grounding electrodes, and requirements of the grounding electrode.

Lightning Protection

For added protection of the TV during a lightning storm or when it is left unattended or unused for long periods of time, unplug the TV from the wall outlet and disconnect the antenna or cable system.

Power Lines

Do not locate the antenna near overhead light or power circuits, or where it could fall into such power lines or circuits. Remember, the screen of the coaxial cable is intended to be connected to earth in the building installation.

Installation of CATV

The installation instructions states the cable distribution system should be grounded (earthed) in accordance with ANSI/NFPA 70, the National Electrical Code (NEC), in particular Section 820.93, Grounding of Outer Conductive Shield of a Coaxial Cable.

Installation of Antenna

The installation instructions states the cable distribution system used for connection to antennas and dishes should be grounded (earthed) in accordance with ANSI/NFPA 70, the National Electrical Code (NEC), in particular Section 810.21, Bonding Conductors and Grounding Electrode Conductors — Receiving Stations.

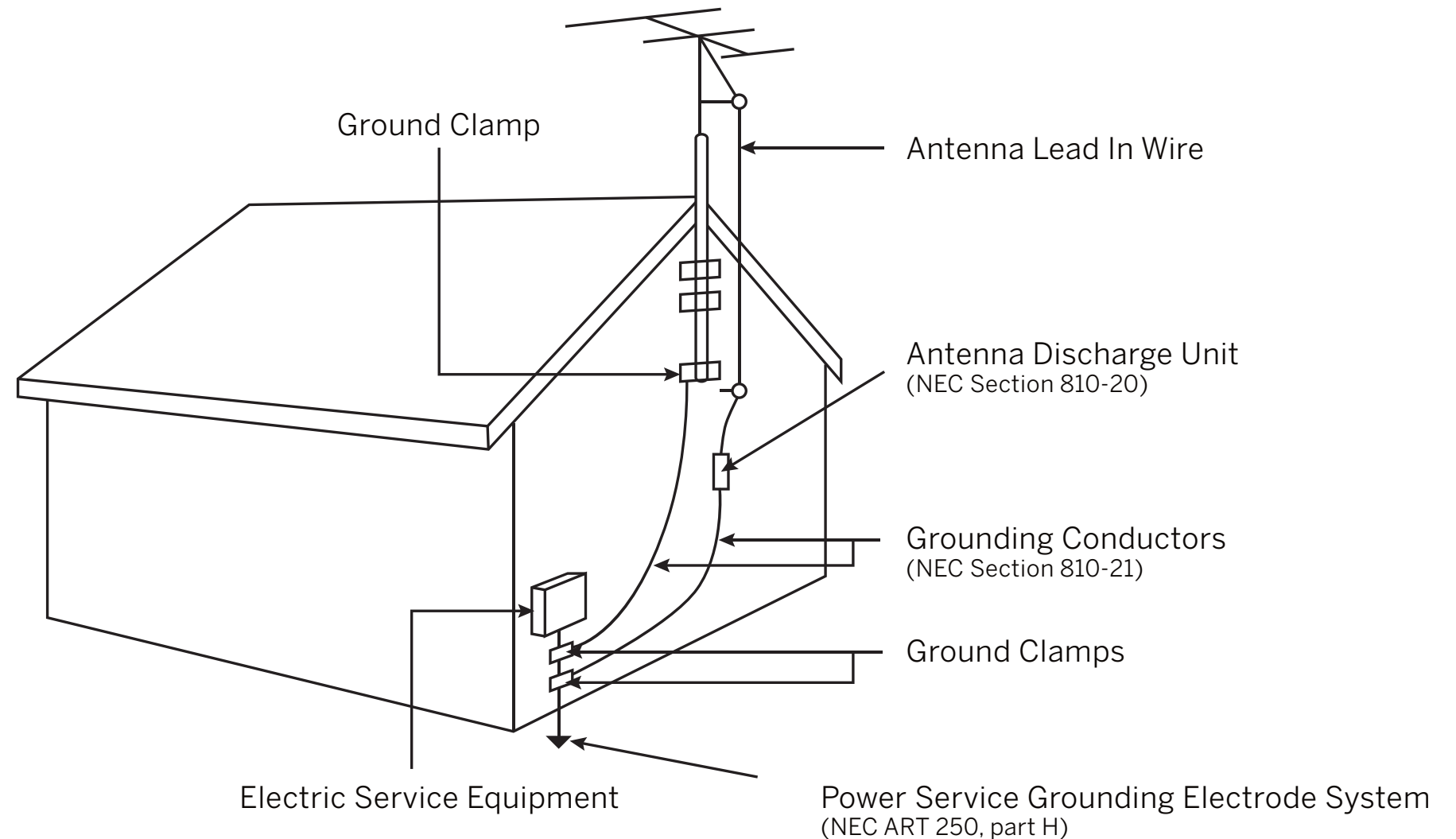

 **Dolby Vision**

 **Dolby Audio**

Dolby, Dolby Vision, Dolby Audio, and the double-D symbol are trademarks of Dolby Laboratories Licensing Corporation. Manufactured under license from Dolby Laboratories. Confidential unpublished works. Copyright © 1992-2021 Dolby Laboratories. All rights reserved.

 **HDMI**[®]
HIGH-DEFINITION MULTIMEDIA INTERFACE

The terms HDMI, HDMI High-Definition Multimedia Interface, and the HDMI Logo are trademarks or registered trademarks of HDMI Licensing Administrator, Inc.

 **dts x**[™]
DTS:X[®] Cinema Quality
Immersive Audio

 **dts**[®]
DTS[®] Virtual:X[™]
Virtualized 3D Sound

For DTS patents, see <http://patents.dts.com>.

Manufactured under license from DTS, Inc. DTS, DTS:X, Virtual:X, the DTS:X logo are registered trademarks or trademarks of DTS, Inc. in the United States and other countries. © 2021 DTS, Inc. ALL RIGHTS RESERVED.

Getting to Know Your TV

FRONT PANEL

Remote Sensor and Power Indicator

When using the remote, aim it directly at the sensor.

The power indicator flashes on when the TV turns on, then goes out after several seconds.

To keep the power indicator on, see *Turning the Power Indicator On or Off on page 30*.



POWER/INPUT BUTTON

(located under the sensor)

When TV is OFF:

Press to turn on the TV.

When TV is ON:

Press to change to the next input source.

Press, hold (3 seconds) and release to turn TV off.

Press and hold (12 seconds) to reset TV to default settings.

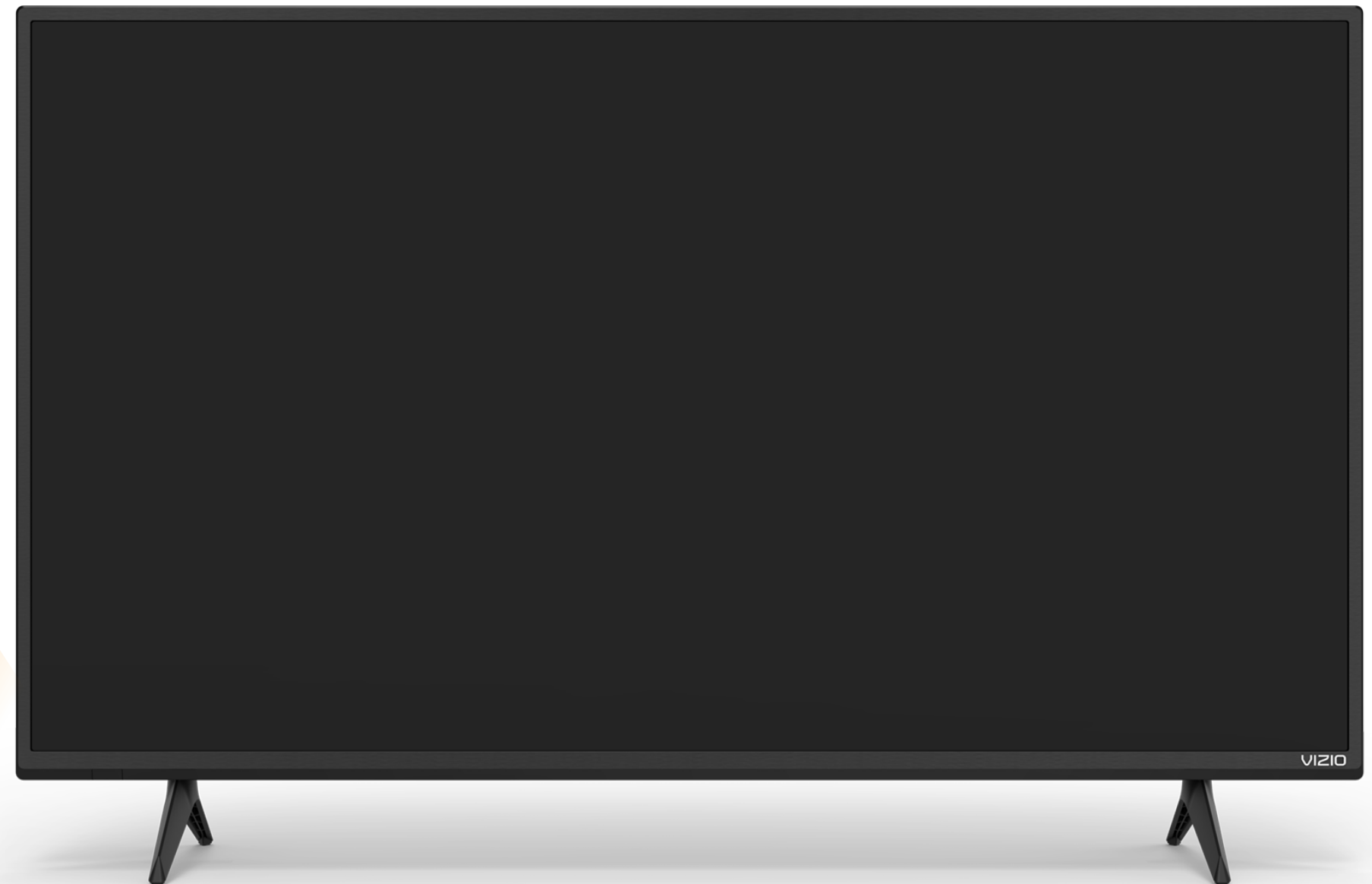

REAR PANEL

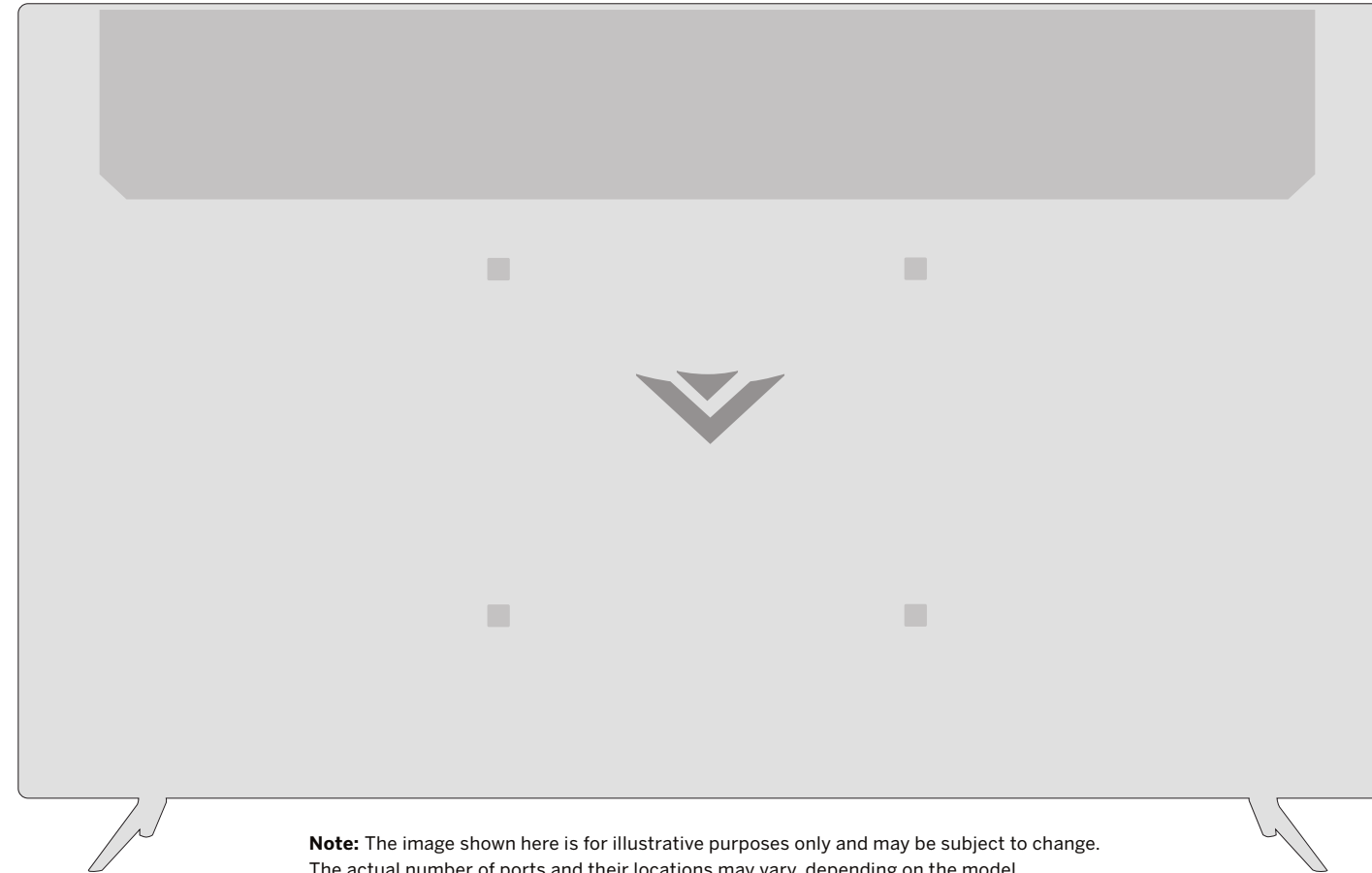

Note: The image shown here is for illustrative purposes only and may be subject to change. The actual number of ports and their locations may vary, depending on the model.



HDMI

Connect an HDMI device



Stereo Audio Out

Connect to an RCA device, such as sound bar



Optical Audio Out

Connect an optical/SPDIF audio device, such as a home audio receiver



Ethernet

Connect an Ethernet cable to a modem/router



USB

Connect a USB thumb drive to play music or video, or display photos



Coaxial

Connect a coaxial cable from cable, satellite, or antenna

Connecting a device — AUDIO & VIDEO CABLE TYPES

Your TV can be used to display output from most devices.

1. Verify that your device has a video port that matches an available port on the TV (HDMI, Coaxial, etc.).
2. Connect the appropriate cable (not included) to the TV and the device.
3. Turn the TV and your device on.
4. Set the TV's input to match the connection you used (HDMI-1, HDMI-2, etc.).

Note: Cables mentioned in this manual are not included

HDMI CABLE

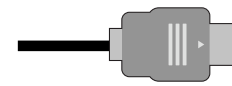

HDMI

COAXIAL CABLE



Coaxial

Connecting a device — AUDIO CABLE TYPES

Your TV can be output sound to an audio device, such as a receiver or sound bar.

1. Verify that your device has an audio port that matches an available port on the TV.
2. Connect the appropriate cable (not included) to the TV and the device.
3. Turn the TV and your device on.

HDMI CABLE

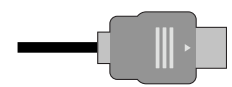

HDMI

OPTICAL/SPDIF CABLE

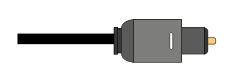

Optical

RCA STEREO CABLE

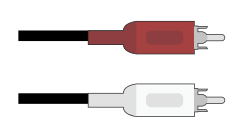

R

L

Note: The actual ports and their locations may vary, depending on the TV model.

WALL-MOUNTING THE TV

First you will need a wall mount. Consult the provided table below to find the appropriate mount for your TV.

Be sure the mount you choose is capable of supporting the weight of the TV.

To install your TV on a wall:

1. Disconnect any cables connected to your TV.
2. Place the TV face-down on a clean, flat, stable surface. Be sure the surface is clear of debris that can scratch or damage the TV.
3. If attached, remove the stands by loosening and removing the screws.
4. Attach your TV and wall mount to the wall by carefully following the instructions that came with your mount. Use only with a UL-listed wall mount bracket rated for the weight/load of your TV.



TIP: Installing a TV on a wall requires lifting. To prevent injury or damage to the TV, ask someone to help you.



WARNING: Do not use the screws that are included inside the wall mount holes to mount TV.

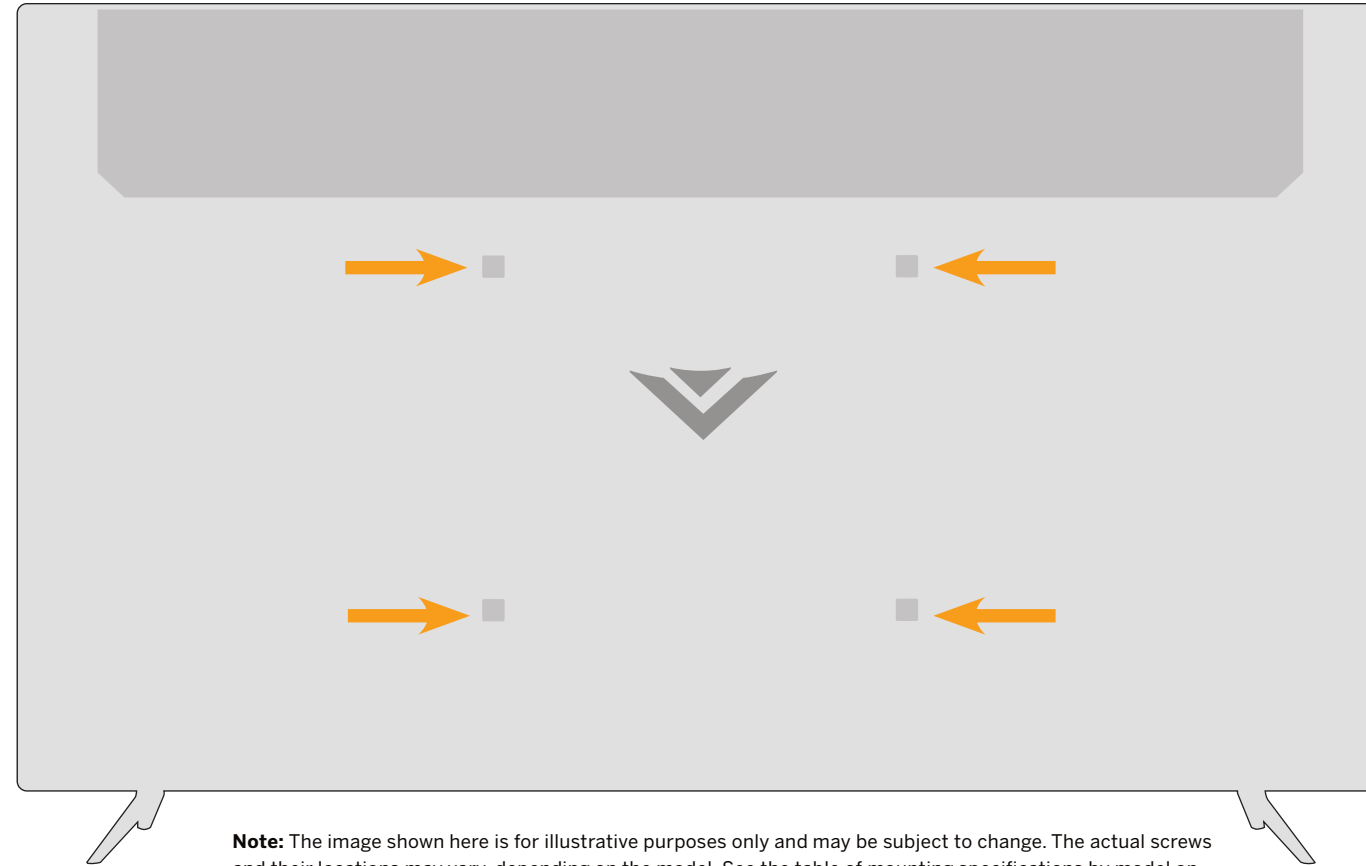

Note: The image shown here is for illustrative purposes only and may be subject to change. The actual screws and their locations may vary, depending on the model. See the table of mounting specifications by model on the following page.

	V435M-K04	V505M-K09	V555M-K01	V585M-K01	V655M-K03	V655M-K04	V705M-K03	V755M-K03
Screw Size	M4	M6	M6 x 14 mm	M6 x 14 mm	M6	M6	M6	M6
# of Screws (not included)	4	4	4	4	4	4	4	4
Hole Depth	10 mm	10 mm	14 mm	14 mm	12 mm	10 mm	12 mm	12 mm
Hole Pattern	200 mm x 100 mm	200 mm x 200 mm	300 mm x 200 mm	300 mm x 200 mm	400 mm x 200 mm	400 mm x 200 mm	400 mm x 200 mm	400 mm x 200 mm
Weight w/o Stand	15.4 lb (7 kg)	18.81 lb (8.53 kg)	28.53 lb (12.94 kg)	31.02 lb (14.07 kg)	40.2 lb (18.2 kg)	36.78 lb (16.68 kg)	51.6 lb (23.4 kg)	60.4 lb (27.4 kg)

USING THE REMOTE

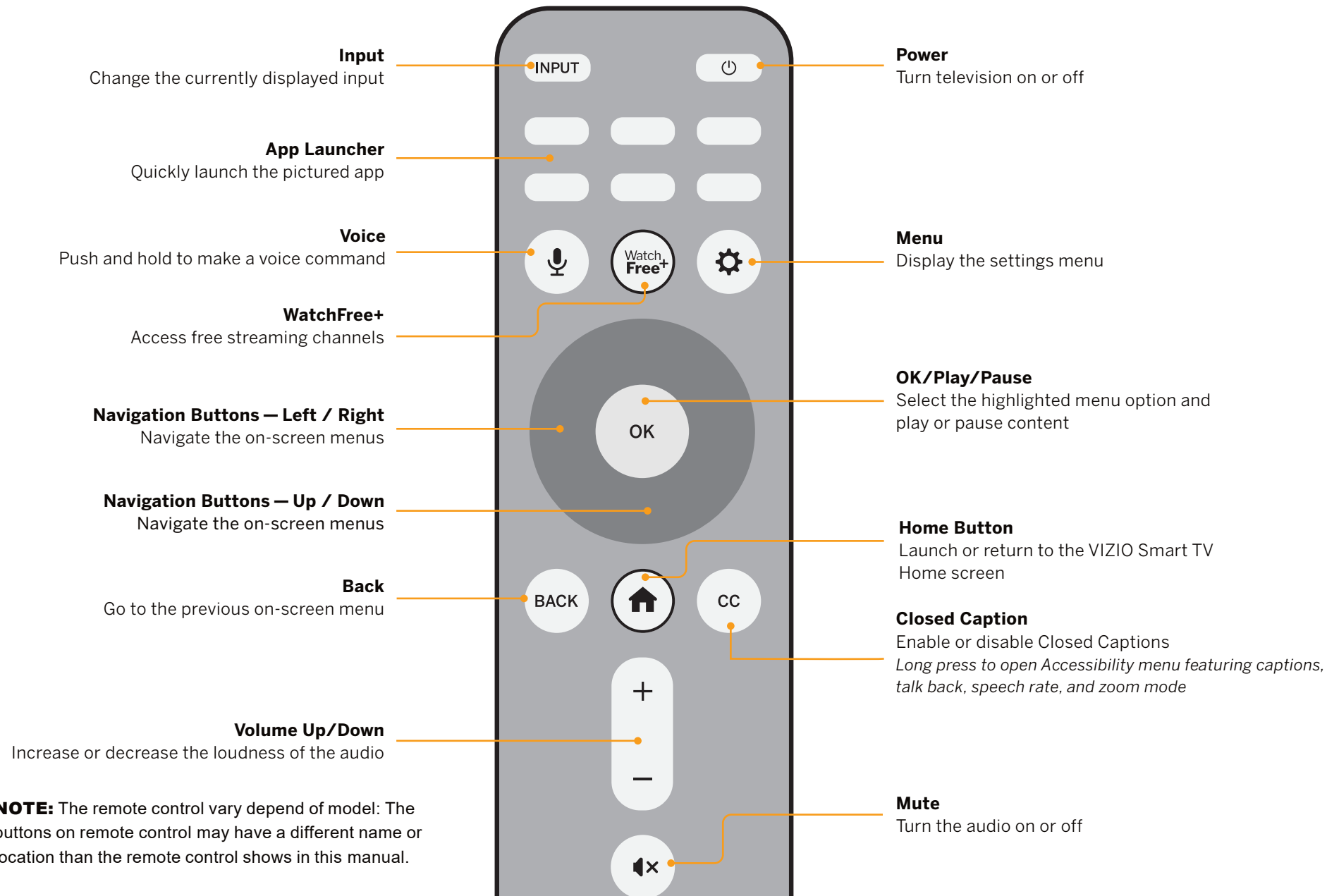

Replacing the Batteries (Not supplied)

1. Push and slide the cover down. Then lift the cover to access the battery compartment.
2. Insert two batteries into the remote control. Make sure that the (+) and (-) symbols on the batteries match the (+) and (-) symbols inside the battery compartment.
3. Replace the battery cover and slide to close.

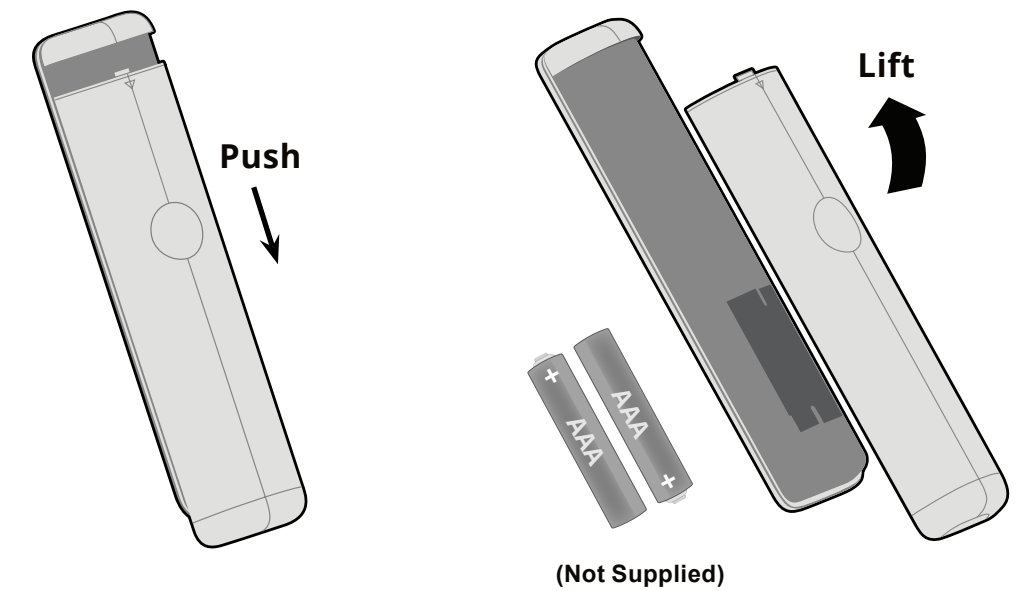

In many places batteries cannot be thrown away or discarded with household waste. Please ensure you properly dispose of your batteries consistent with the laws and/or regulations where you live. For more information please visit: www.vizio.com/environment

WARNING: Keep the remote control batteries away from children. It may cause choking and/or lead to a fire or chemical burn if mishandled. Do not dispose of batteries in fire. Replace only with batteries of the correct type. Risk of fire or explosion if the battery is replaced by an incorrect type.

TIP: When needed, VIZIO recommends replacing the batteries with two, new Duracell 'AAA' alkaline batteries.

POWER UP WITH DURACELL®

USING VOICE CONTROL

You can easily control your TV with the included Voice Remote.

To pair your remote to the TV:

During first-time setup, your remote should automatically pair to your TV with Bluetooth.

To manually pair:

Press the **MIC**  button to launch pairing mode.



TIP: The voice remote must be within close enough range of the TV to pair properly.

NOTE: The remote control vary depend of model: The buttons on remote control may have a different name or location than the remote control shows in this manual.

How to use the voice control:

1. Push and hold the **MIC**  button while speaking a command.

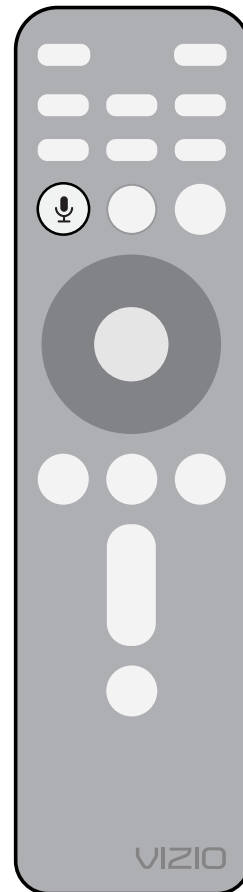



Here are some phrases you can say:

 "Find free comedy movies."

 "Switch input to HDMI-2."

 "Launch WatchFree+."

 "Turn on captions."

 "Lower volume to 10."



vizio.com/qr/XRT260

Scan to learn more.

Scan with your phone camera or QR reader.

Using the SmartCast Mobile app for voice control:

You can also use the free VIZIO SmartCast Mobile app as a voice control remote. See *Controlling your TV with the VIZIO Mobile App on page 35* for more information.

Connect to other popular voice assistant devices:

VIZIO TVs also work with Google Assistant, Siri, and Alexa-enabled devices for hands-free voice control.

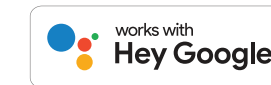

TIP: If you want to use a voice assistant to turn your TV on, make sure Quick Start Mode is enabled. See *Adjusting the Power Mode on page 29*.

This device is equipped with the VIZIO Voice feature. By activating the VIZIO Voice feature (either through the mobile application or Bluetooth remote), you can control your Smart TV, and use many of its features, with voice commands. In order to provide you the VIZIO Voice feature, some voice commands may be transmitted to a third-party service provider that will translate your voice command into text and provide VIZIO Voice features. We may also capture and collect voice commands and associated text(s) in order to provide the VIZIO Voice feature and evaluate and improve the features. VIZIO will only capture voice commands when you press the microphone button on your remote or mobile app and speak into the microphone on the remote control or mobile phone. You may disable the VIZIO Voice feature for your remote at any time by unpairing your Bluetooth remote.

Completing the First-Time Setup

Before you begin the first-time setup:

- Your TV should be installed and the power cord should be connected to an electrical outlet.
- If you have a wireless network, have the network password ready.
- If you are connecting to your network with an Ethernet cable, connect one end of the cable to the Ethernet port on the TV.

The first time you turn on the TV, the on-screen instructions will guide you through each of the steps necessary to get your TV ready for use:

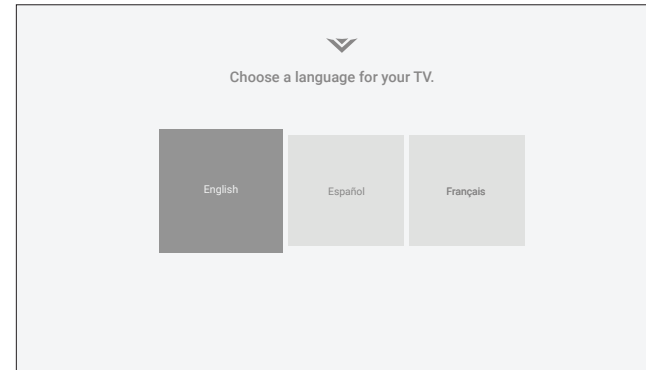

1. Choose your language. Pressing the **CC** button will enable TTS (text-to-speech) functionality. Pressing the **Down Navigation** button will enable Store Demo mode.

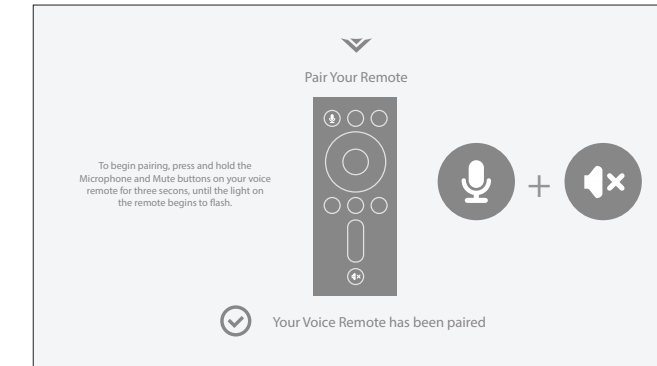

2. Pair your voice remote.

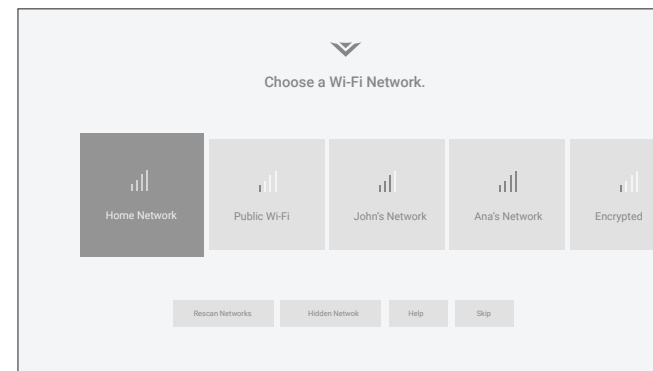

3. Choose your Wi-Fi network and enter the password.

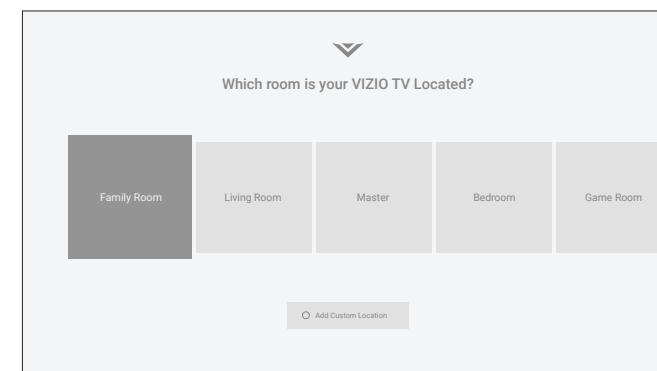

4. Name your TV.

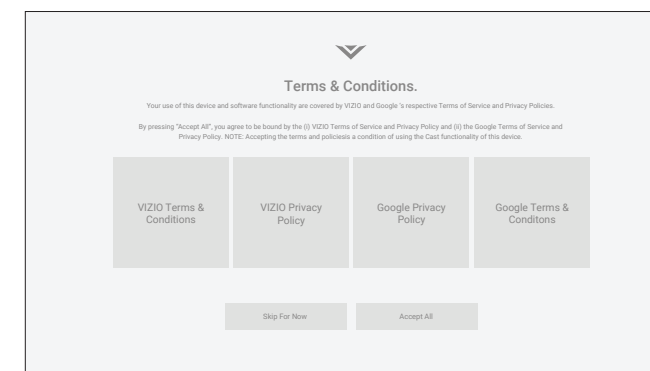

5. Accept the Terms & Conditions.

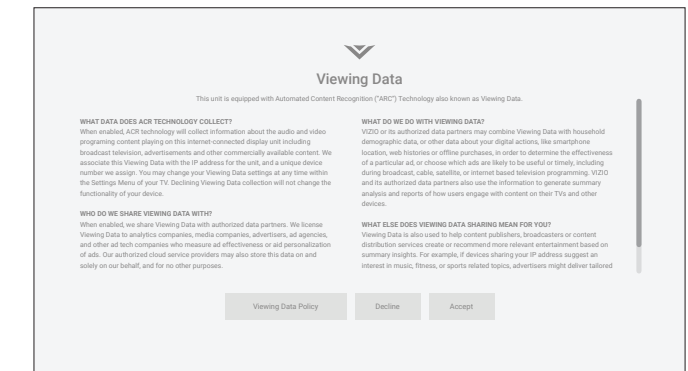

6. View and accept VIZIO Viewing Data Policy.

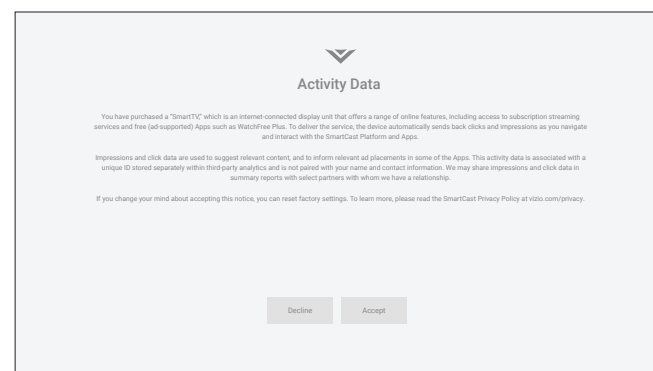

7. View and accept the Activity Data Policy.

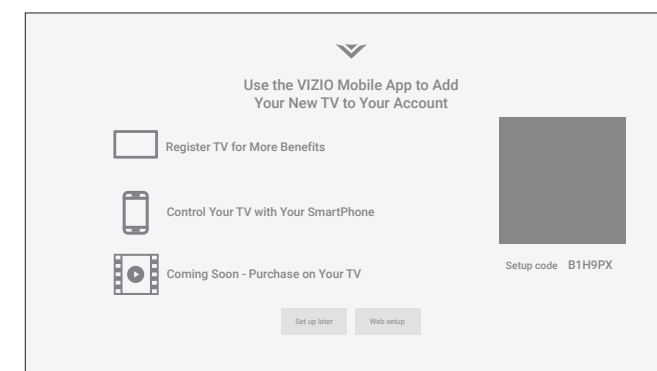

8. Add your TV to your account.



Using the On-Screen Menu

CHANGING THE INPUT SOURCE

External devices, such as DVD players, Blu-ray players, and video game consoles, can be connected to your TV. To use one of these devices with your TV, you must first change the input source using the input menu.

To change the input source:

1. Press the **INPUT** button on the remote. The input menu is displayed on the left of the screen.
2. Use the **Navigation** buttons or the **INPUT** button on the remote to highlight the input you wish to view. The corresponding inputs are named on the back of your TV.
3. Press **OK**. The selected input is displayed.

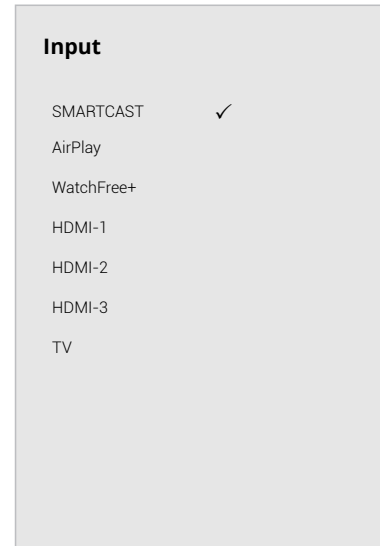

Input Name

The input with the check mark to the right of it is the current input selected. Inputs may vary by TV.



TIP: You can change the input names that appear on the Input menu to make your devices easy to recognize. See *Renaming Devices on the Input Menu on page 29*.

NAVIGATING THE ON-SCREEN MENU

To open the on-screen menu:

1. Press the **MENU** button on the remote.
2. Use the **Navigation** buttons to highlight a menu option, and press the **OK** button to select that option.

From this menu, you can:

- Set up Bluetooth Headphones
- Adjust picture settings
- Adjust audio settings
- Adjust network settings
- Adjust TV channel settings
- Adjust accessibility settings
- Adjust TV system settings
- Access admin and privacy settings
- View the user manual

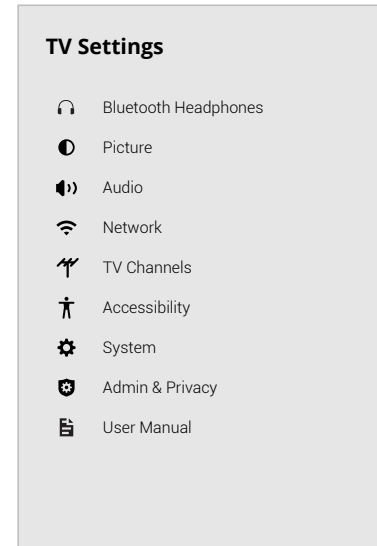

TIP: While navigating the on-screen menu, you can press the **BACK** button at any time to return to the previous menu screen.

PAIRING BLUETOOTH HEADPHONES

Your TV can be paired with Bluetooth headphones for listening to audio.

To pair Bluetooth headphones:

Menu > Bluetooth Headphones

1. Set your Bluetooth headphones to pairing mode (see your device manual for instructions). The headphones will appear in the list of **Other Devices**.
2. Select the Bluetooth headphones and press the **OK** button.
3. Once paired, the device will be listed under **Paired Devices** and is ready for listening.

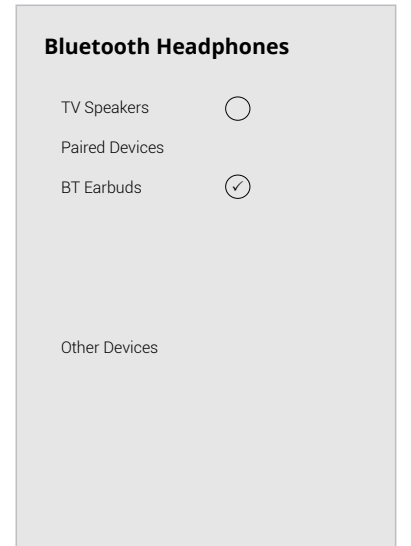

ADJUSTING THE PICTURE SETTINGS

Your TV can be adjusted to suit your preferences and viewing conditions.

To adjust the picture mode settings:

Menu > Picture > Picture Mode

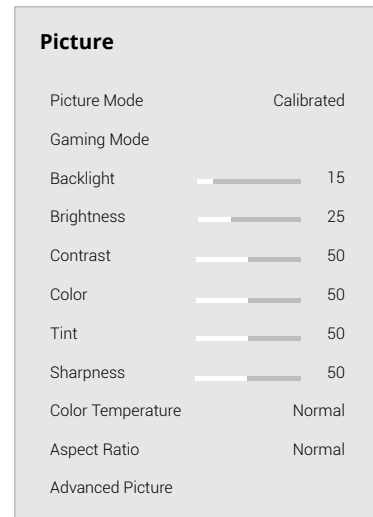

1. Use the **Navigation** buttons on the remote to highlight **Picture Mode**, then use the **Left/Right Navigation** buttons to change the picture mode:
 - **Vivid** — Sets the picture settings to values that produce a brighter, more vivid picture.
 - **Bright** — Great for viewing everyday TV, such as news and TV shows, that requires a brighter image with motion enhancements.
 - **Calibrated** — Accurate colors intended for cinema content viewing in a bright room.
 - **Calibrated Dark** — Accurate colors intended for cinema content viewing in a dark room or at nighttime.
 - **Game** — Reduces throughput delays and optimizes the picture settings for displaying game console output. Also the preferred picture mode for computer mode.
 - **Sports** — Sets the picture settings to values ideal for watching sporting events with motion control setting.

2. Select Gaming Mode for access to gaming-related information and settings:

- **Game Low Latency** — When enabled, reduces video delay lag.
 - **Variable Refresh Rate (VRR)** — When enabled, adjusts the refresh rate of the screen based on the content.
 - **Game HDR** — When enabled, optimizes the picture quality for HDR games.
 - **HDMI Mode** — Adjusts the picture to correctly support display output of older devices.
3. To manually change each of the picture settings, use the **Up/Down Navigation** buttons on the remote to highlight a picture setting, then use the **Left/Right Navigation** buttons to adjust the setting:
 - **Backlight (SDR content)** — Adjusts the LED brightness to affect the overall brilliance of the picture.
 - **Brightness** — Adjusts the black level of the picture. When this setting is too low, the picture may be too dark to distinguish details. When this setting is too high, the picture may appear faded or washed out.
 - **Contrast** — Adjusts the white level of the picture. When this setting is too low, the picture may appear dark. When this setting is too high, the picture may appear faded or washed out. If the setting is too high or too low, detail may be difficult to distinguish in dark or bright areas of the picture.
 - **Color** — Adjusts the intensity of the picture colors.
 - **Tint** — Adjusts the hue of the picture. This setting is useful in adjusting the flesh tones in the picture. If flesh appears too orange, reduce the level of color before adjusting tint.
 - **Sharpness** — Adjusts the edge sharpness of picture elements. It can be used to sharpen non-HD (high definition) content; however, it will not produce detail that does not otherwise exist.



TIP: If you save changes to the setting for a picture mode, an asterisk will appear after its name. See *Saving a Custom Picture Mode* on page 19.

Adjusting the Color Temperature

Adjusting the color temperature changes the white balance of the picture.

To adjust the color temperature:

Menu > Picture > Color Temperature

Use the **Navigation** buttons on the remote to highlight a color temperature preset, then press **OK**.

- **Warm** — Produces an orange-hued picture.
- **Cool** — Produces a blue-hued picture.
- **Normal** — Optimized for television viewing.

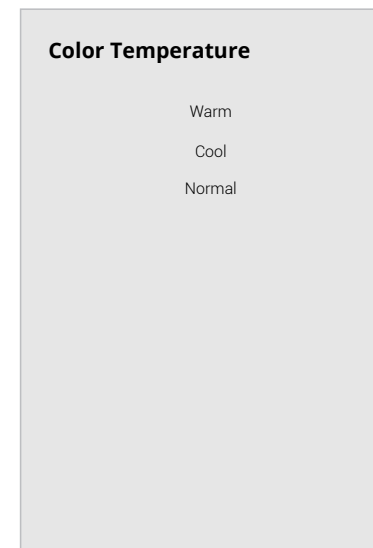

Changing the Picture Aspect Ratio

To change the screen aspect ratio:

Menu > Picture > Aspect Ratio

Use the **Navigation** buttons to highlight the aspect ratio you wish to apply.

Your TV can display images in different modes:

- **Normal (default)** — No change to aspect ratio.
- **Stretch*** — When the 16:9 signal is a 4:3 image with black bars on the left and right, the image will be stretched to fill the screen.
- **Panoramic*** — Stretches a 4:3 image to fill a 16:9 screen with an algorithm so the center doesn't look stretched.
- **Wide** — Stretches a 4:3 aspect ratio to fill a 16:9 screen. If the signal is a 16:9 image, black bars are added to the top and bottom.
- **Zoom** — Expands image both horizontally and vertically by 14%.

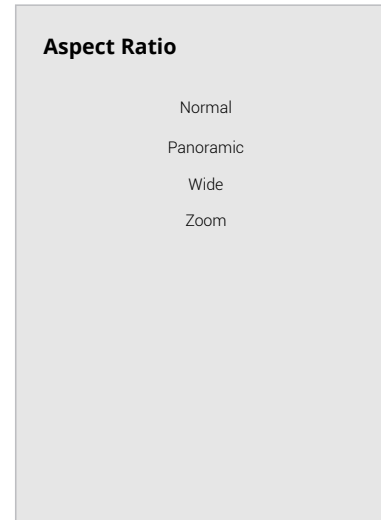

Some programs have black bars on the top and bottom or sides of the screen so the picture keeps its original shape. Examples include widescreen movies and older TV programs.



TIP: The aspect ratio cannot be changed for Ultra HD content or HDR content.

Adjusting Advanced Picture Settings

To adjust advanced picture settings:

Menu > Picture > Advanced Picture

Use the **Navigation** buttons to highlight the setting you wish to adjust, then press the **Left/Right Navigation** buttons to change the setting:

- **Black Detail** — Adjusts the average brightness of the picture to compensate for large areas of brightness.
- **Super Resolution** — Configures the resolution to enhance dim and blurred pictures resulting in a sharper image.
- **Edge Enhancement** — Increases the smoothness of edges.
- **Local Contrast** — Adjust the contrast of the picture locally.
- **Backlight Control** — Dynamically improves the contrast ratio of the picture by adjusting the backlight.

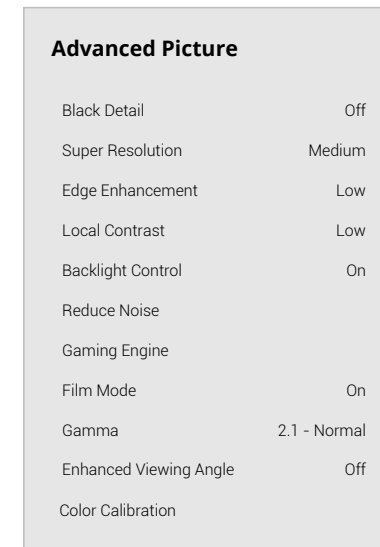

- **Reduce Noise:**
 - **Signal Noise:** Reduces background picture noise when viewing analog sources. This function helps to correct "speckle" noise with a slight reduction in sharpness.
 - **Block Noise:** Reduces the side effects of digital compression such as "blocking" and noise on sharp edges. The High setting will cause a slight reduction in sharpness.
 - **Contour Smoothing:** Removes visible contour noise without loss of the complex detail.
- **Film Mode** — Optimizes the picture for watching films. Select **On** or **Off**.
- **Gamma** — Set the shape of the Gamma curve. Use lower Gamma values for bright room conditions, and higher values when it's dark.
- **Color Calibration** — Calibrate colors using HSB, gain, offset, and 20 point white balance and test or reset colors to defaults.

*Available aspect ratio settings may vary by input source. Panoramic mode is only available for standard definition TV (480i/480p) and Stretch mode is only available for high definition TV (720p/1080i/1080p).

Adjusting the Color Tuner Settings

The Color Tuner settings allow you to adjust the color management system, 20 point white balance, turn color channels off for testing, and display SMPTE, flat, ramp, and uniformity analyzer test patterns.

To access the color tuner table:

Menu > Picture > Advanced Picture > Color Calibration > Color Tuner



WARNING: The Color Tuner, White Balance, and test patterns allow technicians to manually calibrate the TV. Calibration requires specialized training, an input with precisely set colors, and a specialized light meter.

To turn color channels off and on:

1. Use the **Navigation** buttons on the remote to highlight **Red, Green, or Blue**.
2. Press the **OK** button to turn the color channel off or on. An **X** appears over a color channel that has been turned off.
3. Only two color channels can be turned off at the same time.



TIP: Any changes made affect the color temperature setting. Select the preferred color temperature setting first. See *Adjusting the Color Temperature on page 15*.

To adjust the color management system settings:

1. Use the **Navigation** buttons on the remote to highlight the Hue, Saturation, Brightness, Offset, or Gain of the color you wish to adjust. Press the **OK** button.
2. Use the **Left/Right Navigation** buttons to adjust the value. When you are finished press the **OK** button to save the setting.

Color Tuner						
	Red	Green	Blue	Cyan	Magenta	Yellow
Hue	0	0	0	0	25	-14
Saturation	-1	5	-4	0	-2	0
Brightness	-24	0	-22	0	0	0

To adjust the White Balance Tuner settings:

Menu > Picture > Advanced Picture > Color Calibration > White Balance Tuner

1. Use the **Navigation** buttons on the remote to highlight the Gain and Color values you wish to adjust. Press the **OK** button and use the **Left/Right Navigation** buttons to adjust the value. When you are finished, press the **OK** button to save the setting.

White Balance Tuner			
	Red	Green	Blue
IRE% 5	0	0	0
Offset	0	0	0
Gain	0	0	0

To reset the 20 point white balance, offset, and gain to the defaults:

Menu > Picture > Advanced Picture > Color Calibration > Reset Color Temperature

To show or hide the SMPTE Test Pattern:

Menu > Picture > Advanced Picture > Color Calibration > Calibration Test > SMPTE Test Pattern

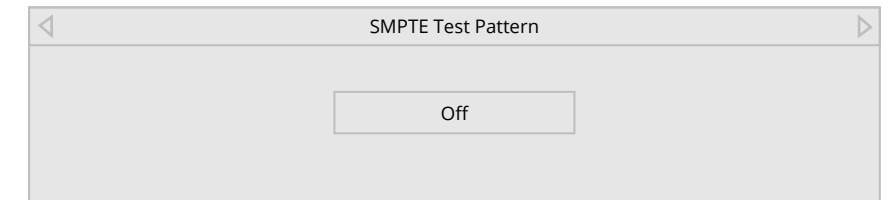

1. Use the **Navigation** buttons on the remote to highlight Off. Use the **Left/Right Navigation** buttons to select On to show the SMPTE Pattern.

—or—
2. To hide the SMPTE Test Pattern, use the **Left/Right Navigation** buttons to select Off.

To show or hide the Flat Test Pattern:

Menu > Picture > Advanced Picture > Color Calibration > Calibration Test > Flat Test Pattern

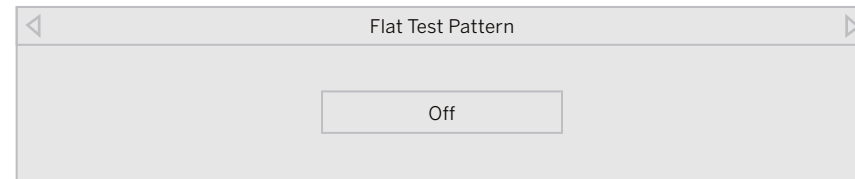

1. Use the **Navigation** buttons on the remote to highlight Off. Use the **Left/Right Navigation** buttons to select the percentage brightness for the flat test pattern. Selecting a percentage immediately shows the flat pattern at that brightness.

—or—

2. To disable the Flat Test Pattern, use the **Left/Right Navigation** buttons to select **Off**.

To show or hide the Ramp Test Pattern:

Menu > Picture > Advanced Picture > Color Calibration > Calibration Test > Ramp Test Pattern

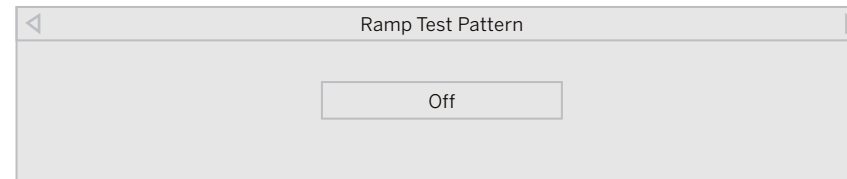

1. Use the **Navigation** buttons on the remote to highlight Off. Use the **Left/Right Navigation** buttons to select the color for the ramp test pattern. Selecting a color immediately shows that color ramp.

—or—

2. To hide the Ramp Test Pattern, use the **Left/Right Navigation** buttons to select **Off**.

To show or hide the Uniformity Analyzer Test Pattern:

Menu > Picture > Advanced Picture > Color Calibration > Calibration Test > Uniformity Analyzer Test Pattern

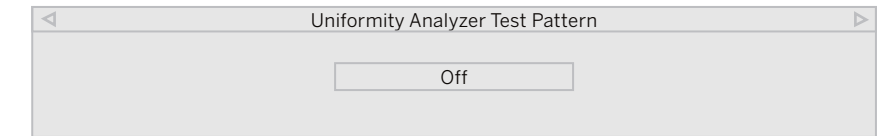

1. Use the **Navigation** buttons on the remote to highlight Off. Use the **Left/Right Navigation** buttons to select **On** to show the Uniformity Analyzer Test Pattern.

—or—

2. To hide the Uniformity Analyzer Test Pattern, use the **Left/Right Navigation** buttons to select **Off**.

Adjusting Picture Input Settings

Enable HDMI Mode, Full Color 4:4:4, and adjust picture size and position.

To adjust the Input settings:

Menu > Picture > Input Picture Settings

Use the **Navigation** buttons to highlight the setting you wish to adjust.

- **Picture Size and Position*** — configure the display size and position of the picture to the screen.
- **HDMI Mode*** — If necessary, to support correct picture of older devices, override the automatic setting to use legacy HDMI mode.
- **Full Color 4:4:4*** — Maintains full color data with 4:4:4 content. Some picture settings will not be available when this setting is **On**. Only available for an HDMI input.
- **Color Space Range** — Select Color Space for the source. Video sources uses YCbCr, but PC uses RGB.

Adjusting the Picture Mode Edit Settings

Manage custom picture modes and reset preset picture modes.

To adjust the Picture Mode Edit settings:

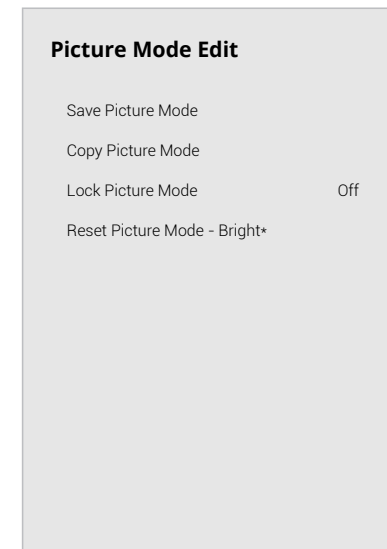

Menu > Picture > Picture Mode Edit

Use the **Navigation** buttons to highlight the setting you wish to adjust, then press **OK** to change the setting:

- **Save Picture Mode** — Save a custom picture mode.
- **Copy Picture Mode** — Copy the settings for a custom picture mode.
- **Lock Picture Mode** — Prevent changes to custom picture modes.
- **Reset Picture Mode** — Reset the picture mode settings to factory default values. Only available on customized preset modes.
- **Delete Picture Mode** — Delete a custom picture mode. Inputs assigned to the custom picture mode will use the Calibrated picture mode.

Saving a Custom Picture Mode

Custom picture modes allow you to save a group of custom settings for various viewing conditions and video sources.

To save a custom picture mode:

Menu > Picture > Picture Mode Edit > Save Picture Mode > Enter a Name > Save

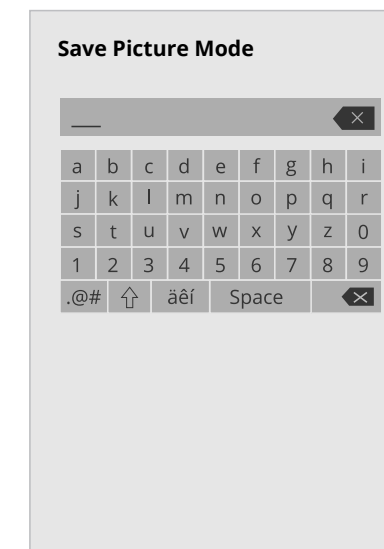

Custom picture modes allow you to save a group of custom settings for various viewing conditions and video sources.

- Changes made while on any preset picture mode will add an asterisk on the top right corner of the preset mode.
- The custom picture mode is not automatically saved.

*Only available if there is an input source. Not available for WatchFree+. Menu items will be grayed out if not available.

Copy a Picture Mode

Custom picture mode settings can be copied to be applied to other inputs.

1. Complete the desired changes for the selected picture mode.
 - Select **Save Picture Mode** to save picture mode for all inputs.
2. Select the input you want to copy your saved picture mode edits to.
3. Change the picture mode to your custom saved mode: **Menu > Picture > Picture Mode > select saved custom picture mode**
4. Copy your custom picture mode: **Menu > Picture > Picture Mode Edit > Copy Picture Mode**
5. Select what picture mode you would like to copy over.
6. A notification displays after the copy to your selected picture mode is completed. Now this picture mode will have your custom settings saved over it for the selected input.
7. Repeat as needed to customize additional inputs.

Lock a Picture Mode

Custom picture modes can be locked/unlocked with a unique PIN to prevent accidental changes to their settings. If not previously set, you can set up your system PIN code here.

To lock all custom picture modes:

Menu > Picture > Picture Mode Edit > Lock Picture Mode > On > Enter Your PIN > Save

To unlock all custom picture modes:

Menu > Picture > Picture Mode Edit > Lock Picture Mode > Off > Enter Your PIN

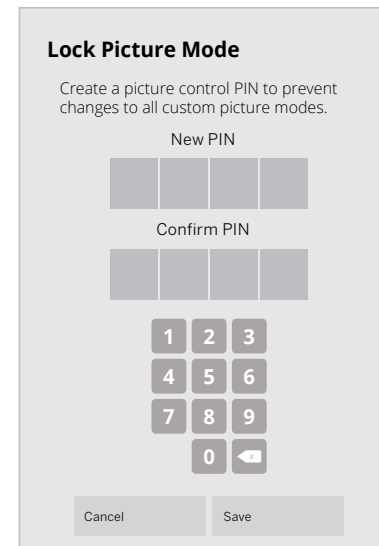

TIP: To set a custom PIN code, see *Setting a System PIN Code on page 31*.

Deleting a Picture Mode

Custom picture modes that are no longer needed can be deleted.



TIP: Inputs assigned to deleted custom picture modes become assigned to the *Calibration* picture mode.

To delete a custom picture mode:

Menu > Picture > Picture Mode Edit > Delete Picture Mode > Delete

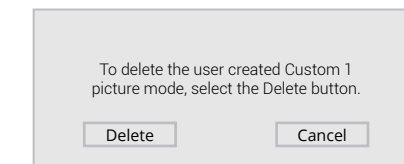

Resetting a Picture Mode

A preset picture mode that has been edited can be restored to the factory default settings.

To reset a customized preset picture mode:

Menu > Picture > Picture Mode Edit > Reset Picture Mode > Reset

ADJUSTING THE AUDIO SETTINGS

To adjust the audio settings:

Menu > Audio

Use the Navigation buttons to highlight the setting you wish to adjust, then press **Left/Right Navigation** buttons to change the setting:

- **TV Speakers** — Turn the built-in speakers **On** or **Off**. The built-in speakers automatically turn off if a sound bar is discovered.
- **Surround Sound** — When set to **On**, enables surround sound suitable for sports and TV shows. Virtual:X™ adds virtualized height best for movies.
- **Volume Leveling** — When set to **On**, DTS TruVolume™ audio solution levels the TV speaker volume.
- **Balance** — Balance the audio loudness between the left and right TV speakers.
- **Bass** — Increase or decrease the bass level.
- **Treble** — Increase or decrease the treble level.
- **Lip Sync** — Synchronize the display image with the audio track.
- **Digital Audio Out** — Select the digital audio output format for both the optical and HDMI ARC audio devices.
 - To hear talk back when **Talk Back** function is enabled, digital audio out must be set to PCM.

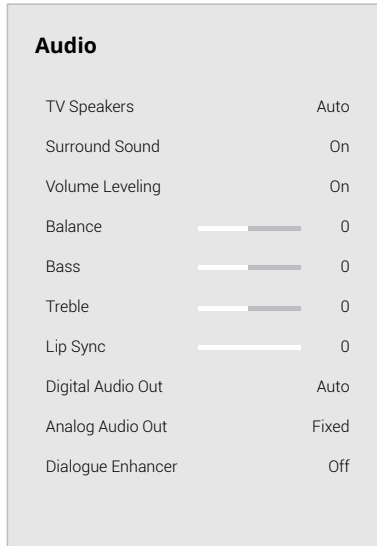

 **TIP:** You must select **Digital** for audio with more than two channels (e.g., 3.0, 5.0, etc.).

- **Analog Audio Out** — Select **Variable** if you are controlling the volume with the TV remote. Select **Fixed** if an external audio device (sound bar or AV receiver) will control the volume.

- **Dialogue Enhancer** — If enabled and the signal source includes Dolby 5.1 AC-4 audio, then clarity of dialogue is enhanced.

SOUND BAR SETTINGS

If a VIZIO sound bar is detected and connected via CEC (HDMI ARC/eARC), sound bar settings will appear in the Audio menu. See *Adjusting the CEC Settings on page 31* to enable CEC under the System settings.

To adjust the sound bar settings:

Menu > Audio > Sound Bar Settings

Use the **Navigation** buttons to highlight the setting you wish to adjust, then press **Left/Right Navigation** buttons to change the setting. See your sound bar manual for details on available settings.

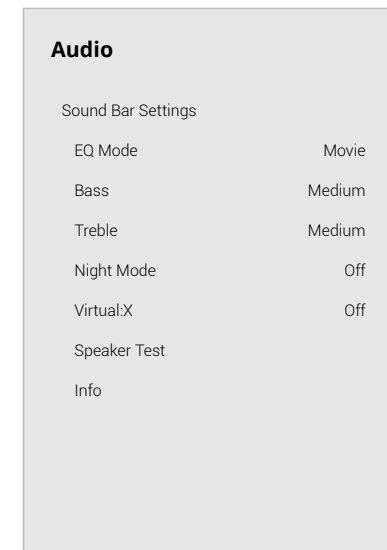

 **TIP:** Available sound bar menu settings will be specific to the type of VIZIO sound bar connected.

ADJUSTING THE NETWORK SETTINGS

Your TV is Internet-ready, featuring both an Ethernet port and built-in high-speed wireless internet.



TIP: If your TV is connected to a network with an Ethernet cable, you will not see the wireless network connection menu. You must unplug the Ethernet cable to set a wireless network connection.

Connecting to a Wireless Network

To connect to a wireless network whose network name (SSID) is being broadcast:

Menu > Network > Choose your network > Enter in the password > Connect

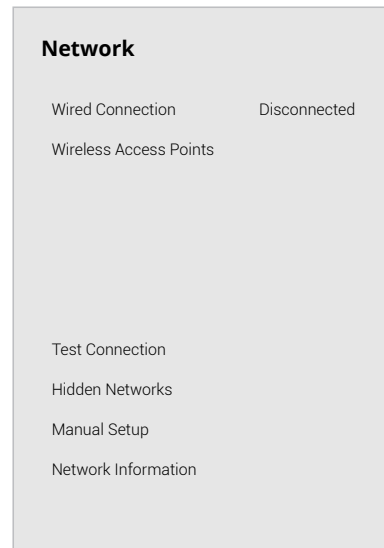

To forget a saved network:

Highlight a saved wireless access point > OK > Forget

If you do not see your wireless network displayed, click on:

More Access Points > Highlight your wireless network > Enter in the password > Connect

Testing Your Network Connection

To test your network connection:

Menu > Network > Test Connection

Connecting to a Hidden Network

To connect to a wireless network whose network name (SSID) is not being broadcast:

Menu > Network > Hidden Network > Enter the Access Point Name > Connect > Enter in the password

Changing the Manual Setup Settings

Advanced users can fine-tune the network settings using the **Manual Setup** feature. The security settings on your router may require you to enter the TV's MAC address.

To change advanced network settings:

Menu > Network > Manual Setup > DHCP > Off

1. Use the **Navigation** and **OK** buttons to adjust each setting:

- **IP Address** — The IP address assigned to the TV.
- **Subnet Mask** — The subnet address.
- **Default Gateway** — Your network's default gateway address.
- **Pref. DNS Server** — Your preferred domain name server address.
- **Alt. DNS Server** — Your alternate domain name server address.

2. Use the **Navigation** buttons on the remote to highlight **Save** and press **OK**.

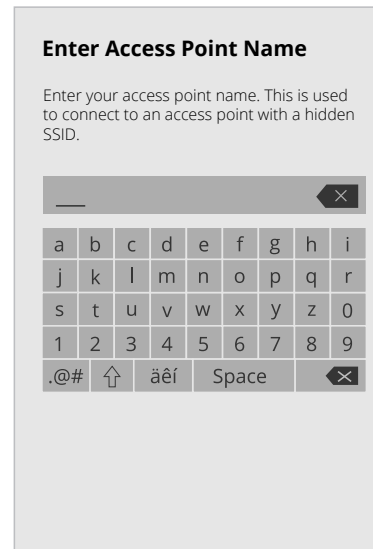

To find the TV's MAC address:

Menu > Network > Manual Setup

You can find your TV's MAC address at the bottom of the list. The MAC addresses for the connections in use are displayed:

- **RJ45 MAC** — The Ethernet or RJ45 MAC address may be needed to set up your network when you have connected the TV to your network when you have connected the TV to your network with an Ethernet (Cat 5) cable.
- **Wireless MAC** — The Wireless (Wi-Fi) MAC address may be needed to connect your TV to your network with Wi-Fi.

Manual Setup	
DHCP	Off
IP Address	_____
Subnet Mask	_____
Default Gateway	_____
Pref. DNS Server	_____
Alt DNS Server	_____
RJ45 Mac	0:0:0:0:0
Wireless Mac	0:0:0:0:0

To view network information

Menu > Network > Network Information

SETTING UP TV CHANNELS

You can use the TV's Channels menu to:

- Find channels
- Find new channels
- Select channels to skip
- Select analog audio mode
- Select the language for digital audio
- Set parental controls

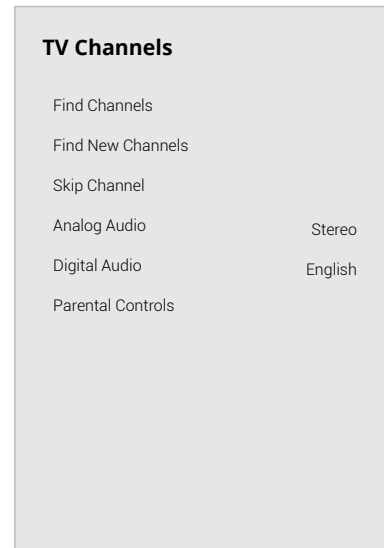

Scanning for TV Channels

The TV may need to scan for channels before it can display programs and their associated information. A channel scan is required for free over-the-air channels (using an antenna) and cable channels from an out-of-the-wall connection (without a cable box). Moving the TV to an area with different channels requires the TV to scan for channels again.

To perform an Auto Channel Scan:

Menu > TV Channels > Find Channels

Wait until the channel scan is 100% complete. Highlight **Done** and press **OK**.

If the channel scan is canceled, the channels that were already discovered are retained.

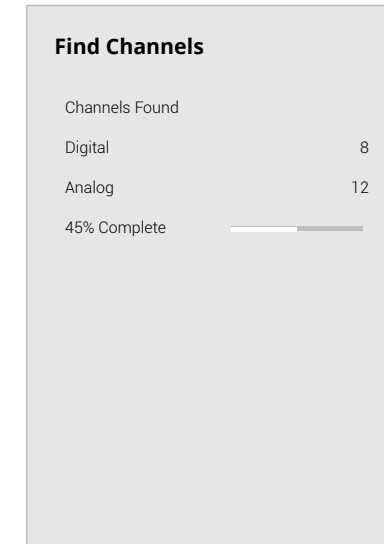

To perform a New Channel Scan:

Menu > TV Channels > Find New Channels

A **New Channel Scan** saves the current channel map and scans for additional channels.

Skipping Channels

After a channel scan is completed, you may find that some channels are too weak to watch comfortably. There may also be some channels you do not want to view. You can remove these channels from the TV's memory with the **Skip Channel** feature.



WARNING: Channels that have been removed with the *Skip Channel* feature can still be viewed if the channel is entered using the number pad.

If you wish to completely block a channel from being viewed, use *see Locking and Unlocking Channels on page 25*.

To remove a channel:

1. From the **TV Channels** menu, highlight **Skip Channel**, and press **OK**. The **Skip Channel** menu is displayed.
2. For each channel you wish to remove, use the **Up/Down Navigation** buttons on the remote to highlight the channel and press **OK**. A ✓ appears to the right of each channel you select.

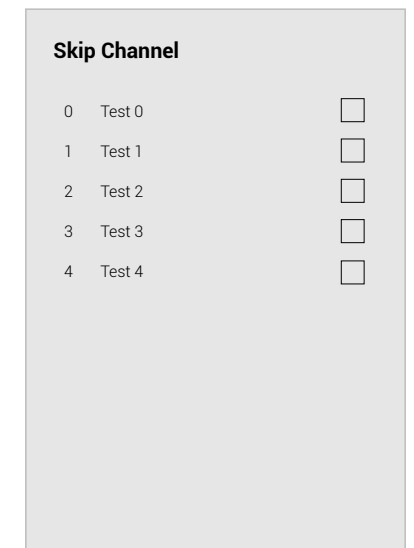

Changing the Analog Audio Language

Some analog over-the-air (free) and cable channels broadcast programs in more than one language. The TV's Analog Audio feature allows you to listen to audio in an alternate language using Secondary Audio Programming (SAP).

To use the Analog Audio feature:

Menu > TV Channels > Analog Audio



WARNING: Not all programs are broadcast in SAP. The Analog Audio Language feature only works when the program being viewed is being broadcast with Secondary Audio Programming.

- **Stereo** — More than one speaker channel is being used. Sounds may be dispersed through different speakers depending on how the audio is programmed.
- **SAP (Secondary Audio Program)** — Typically used for audio in a different language other than the native one used in the program.
- **Mono** — All speakers are producing the same sound; there is no distinction between left or right sounds.

Analog Audio

Stereo
SAP
Mono

To use the Digital Language feature:

Menu > TV Channels > Digital Audio

Select the preferred audio language. Available languages or video description depend on the broadcast content.

Digital Audio

English
Spanish / Video Description
French

Using Parental Controls

The TV's parental controls allow you to prevent the TV from displaying certain channels or programs unless a PIN is used.

Accessing the Parental Controls Menu

To access the **Parental Controls** menu you must first set up a system PIN:



TIP: to set a custom PIN code, see *Setting a System PIN Code on page 31*

Menu > TV Channels > Parental Controls > Enter in PIN

The **Parental Controls** menu only appears when:

- You are using the tuner to receive your TV signals, such as when you are using an antenna for Over-the-Air signals or when connected to cable TV directly from the wall (no cable box).
- You have a device connected using a composite video cable or a coaxial cable, such as a VCR, satellite or cable box, or DVR.



TIP: Other devices have their own parental control settings.

Enabling or Disabling Program Ratings

To manage program content according to its rating, you must first enable the **Program Rating** feature.

To enable or disable the Program Rating feature:

Menu > TV Channels > Parental Controls > Locks > Off/On



Locking and Unlocking Channels

When a channel is locked, it cannot be accessed. Locking a channel is a good way to prevent children from viewing inappropriate material.

To lock or unlock a channel:

Menu > TV Channels > Parental Controls > Channel Locks

Highlight the channel you want to lock or unlock and press **OK**.

- When a channel is locked, the Lock icon appears  locked. The channel is not accessible unless the system PIN is entered.
- When a channel is unlocked, the Lock icon appears  unlocked.

Blocking and Unblocking Content by Rating

A channel may sometimes broadcast programs that are meant for a variety of audiences (some for children and some for adults). You might not want to block the channel completely using a channel lock, but you can block certain programs from being viewed.

You can use the TV's **Rating Block** feature to block content based on its rating.



To block or unblock content by its rating:

1. From the Parental Controls menu, highlight the content type you want to adjust and press **OK**:
 - **USA TV** — USA television program broadcasts.
 - **USA Movie** — USA movie broadcasts.
 - **Canadian English** — Canadian English television program broadcasts.
 - **Canadian French** — Canadian French television program broadcasts.



TIP: For a list of content ratings and their definitions, please visit: www.tvguidelines.org.

2. For each rating type you want to block or unblock, use the **Navigation** buttons to highlight the rating type and press **OK**.

- When the rating type is **blocked**, the Lock icon appears  locked. Content with this rating and all higher ratings cannot be viewed.
- When the rating type is **unblocked**, the Lock icon appears  unlocked. Content with this rating and all lower ratings can be viewed.
- If you want to block all unrated content, highlight **Block Unrated Shows** and use the **Navigation** buttons on the remote to select **On**.

To enable or disable the Block Unrated Shows setting:

Menu > TV Channels > Parental Controls > Block Unrated Shows > Off/On

Reset Locks

Reset all locks to default and clear all channel or ratings locks to the unlocked state.

To reset locks:

Menu > TV Channels > Parental Controls > Reset Locks

ACCESSIBILITY SETTINGS

VIZIO is committed to providing intuitive, user-friendly products. Your new VIZIO TV offers several accessibility features that can help you with easy navigation.

To access the Accessibility menu:

Menu > Accessibility

1. **Captions** — Activate and customize analog and digital closed captions.
2. **Video Description** — If included by the broadcaster, provides a narrated description of the action for the content.
3. **Talk Back*** — Enables your TV to speak all settings changes and adjustments using the remote in English.
4. **Speech Rate** — Adjusts the rate in which Text-to-Speech is spoken. Select Slow, Normal (default), or Fast.
5. **Zoom Mode** — Enlarges a section of the screen by approximately 200%.

Accessibility	
Captions	
Video Description	Off
Talk Back	Off
Speech Rate	Normal
Zoom Mode	Off

To access the Video Description menu:

Menu > Accessibility > Video Description > Off/On



TIP: You can also enable/disable accessibility features using the included remote. See *Using the Remote on page 11*

Setting Up Closed Captioning

Your TV can display closed captions for programs that include them. Closed captions display a transcription of a program's dialogue.



TIP: Closed Captioning is available for tuner and streaming content (if supported by the app). Note that most apps will support their own CC from within the app.

To activate or deactivate Closed Captions for current content:

Menu > Accessibility > Captions > Closed Captions > Off/On

— or —

Push the **CC**  button on the remote.

1. Use the **Navigation** buttons on the remote to highlight either **Analog** or **Digital Closed Captions**.
2. Use the **Left/Right Navigation** buttons on the remote to select the caption channel you wish to display.

Closed Captions	
Closed Captions	Off
Analog Closed Captions	CC1
Digital Closed Captions	CS1
Digital Style	



TIP: The Closed Captions menu does not appear when an HDMI input is selected. Closed Captions are available when using the tuner or a composite video cable.

Changing the Appearance of Digital Closed Captions

Digital closed captions can be displayed according to your preference. See the diagram to the right for an explanation of the parts of the closed caption area.

To change the appearance of digital closed captions:

Menu > Accessibility > Captions > Digital Style

Use the **Up/Down Navigation** buttons on the remote to highlight the setting you wish to change, then use the **Left/Right Navigation** buttons to change the settings (choose "As Broadcast" to keep default settings):

- **Text Style** — Change the font used for the closed captioning text.
- **Text Size** — Make the text larger or smaller.
- **Text Color** — Change the color of the text.
- **Text Opacity** — Change the transparency of the text.
- **Text Edges** — Change the effects at the edges of the text, such as raising the edges or adding drop shadows.
- **Text Edges Color** — Change the color of the text edge effects.
- **Background Color** — Change the color of the background directly behind the text.
- **Background Opacity** — Change the transparency of the background directly behind the text.
- **Window Color** — Change the color of the closed captioning box.
- **Window Opacity** — Change the opacity of the closed captioning box.

Digital Style	
Text Style	As Broadcast
Text Size	Large
Text Color	Blue
Text Opacity	As Broadcast
Text Edges	As Broadcast
Text Edges Color	As Broadcast
Background Color	As Broadcast
Background Opacity	As Broadcast
Window Color	As Broadcast
Window Opacity	As Broadcast

Typical choices include:

- **Opaque background, transparent window** — Only a strip of background appears behind the text, expanding as the text appears. This is the typical "As Broadcast" mode.
- **Opaque background and window in the same color** — When text appears, the entire line fills with color at once.

In the example below, the closed caption text is green, the background is black, and the window is red.

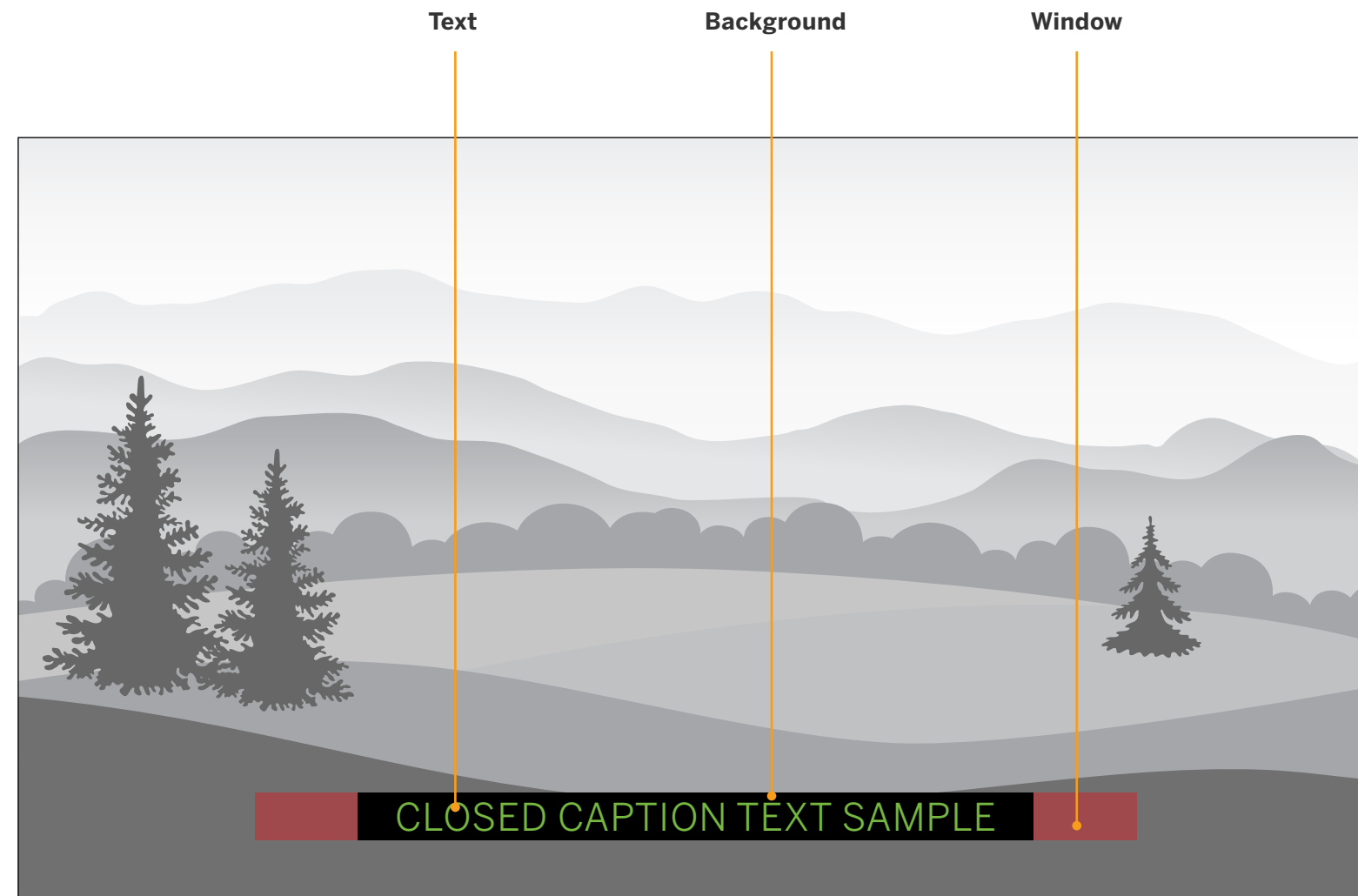

CHANGING THE SYSTEM SETTINGS

Using the System menu, you can:

- Change the on-screen menu language
- Set the time zone and local settings
- Name the TV
- Name an input
- Hide inputs not in use
- Choose the input selected at power on
- Adjust the power mode settings
- Set the USB power mode
- Turn the power indicator on or off
- Set up timers
- Set a system PIN code
- Adjust CEC settings
- Manage paired devices
- Manage a voice remote control

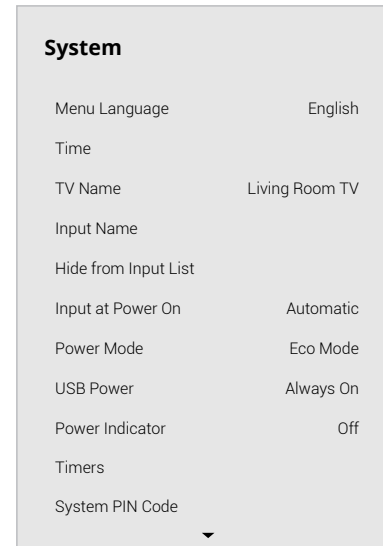

Changing the On-Screen Menu Language

Your TV can display the on-screen menu in different languages.

To change the on-screen menu language:
Menu > System > Menu Language

Highlight your preferred language (English, Español, or Français) and press **OK**.

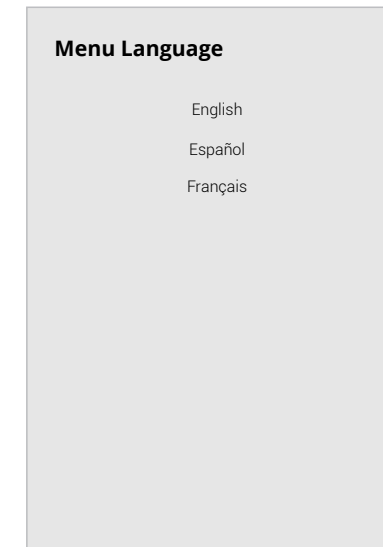

Setting the Time

To ensure the correct time is displayed when you press the **INFO** button, set the TV's time zone:

Menu > System > Time > Time Zone

To turn Daylight Saving Time on or off:

1. Highlight Daylight Saving Time and press **OK**. The **Daylight Saving Time** menu is displayed.
2. Choose **On** if it is currently Daylight Savings Time, **Off** if it is Standard Time, or **Auto** to have the system automatically detect Daylight Savings Settings.

To change Time Format:

Highlight **Time Format** and use the **Left/Right Navigation** buttons to change between a 12-hour format or 24-hour format.

Changing the TV Name

Naming your TV helps differentiate it from other cast devices you may have in your home.

To edit your TV name:

Menu > System > TV Name > Enter a Name



TV Name

Living Room TV

a	b	c	d	e	f	g	h	i
j	k	l	m	n	o	p	q	r
s	t	u	v	w	x	y	z	0
1	2	3	4	5	6	7	8	9
.@#	↑	äëí	Space	✕				

Renaming Devices on the Input Menu

You can rename the inputs to make them easier to recognize on the Input menu. For example, if you have a DVD player connected to the HDMI-1 input, you can rename that input to display “DVD Player.”

See *Changing the Input Source on page 14*.

To change the name of an input:

Menu > System > Input Name

To enter a custom name:

- Highlight the **Name Input** row and press **OK**.
- Enter your custom label using the on-screen keyboard and press **OK**.



TIP: The current input you are on will be the input name you are changing. You cannot change every input (i.e. WatchFree+ or SmartCast inputs).

To Hide an Input from the List:

Menu > System > Hide from Input List

- Highlight the input name you would like to hide. Hidden inputs will not be displayed in the input list.
- Use the **Left/Right Navigation** buttons to toggle from visible and hidden (not all inputs can be hidden).

To Choose the Input selected at power on:

Menu > System > Input at Power On

- Highlight the input name you would like to have selected at power on.
- **SmartCast** is the default setting.

Adjusting the Power Mode

Your TV is set to **Eco Mode** by default. When the TV is powered off, the **Eco Mode** setting uses less than 0.5 W of power. **Quick Start Mode** enables your display to power on faster and also to turn on when powered from another device (such as when you are casting onto the TV).



WARNING: Please note that by changing this setting, the energy consumptions required to operate this device will change.

To switch between Eco Mode and Quick Start Mode:

Menu > System > Power Mode

Highlight either **Eco Mode** or **Quick Start Mode** and press **OK**.



TIP: If you want to use a voice assistant to turn your TV on, make sure **Quick Start Mode** is turned on.

Using the USB Power Feature

The USB port can be used to charge devices.

The two options for this feature are:

- **Always On** — Power is always available.
- **Off When TV Off** — Power is only available with the TV is on.



Turning the Power Indicator On or Off

The power indicator on the front of your TV normally does not glow when the TV is on. You can change this setting if you prefer the light to be on.

To turn the Power Indicator Light On or Off:

Menu > System > Power Indicator > Off/On

Setting Timers

When activated, the TV's timer will turn the TV off after a set period of time.

To setup a sleep timer:

Menu > System > Timers > Sleep Timer

Use the **Left/Right Navigation** buttons on the remote to highlight the period of time after which you want the TV to go to sleep: **30, 60, 90, 120, or 180** minutes. If you don't want the sleep timer to activate, change the setting to Off.

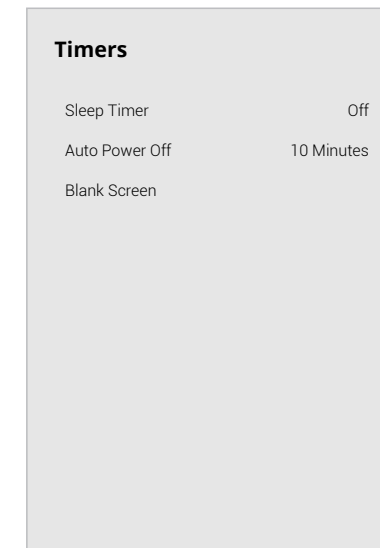

Setting the Auto Power Off Feature

To help save energy, your TV is set by default to turn off after 10 minutes without a video or audio signal. This feature can be deactivated.

To set the Auto Power Off feature:

Menu > System > Timers > Auto Power Off > Off

Using the Blank Screen Feature

To help save LED life, your TV screen can turn on or off while audio is streaming.

To use the Blank Screen feature:

Menu > System > Timers > Blank Screen

To **exit** Blank Screen, press any key (except the volume and mute keys).

Setting a System PIN Code

You can set a system pin to lock content and picture modes, as well as prevent accidental system resets. The first time you select System PIN code, you will need to create a PIN.

To create a PIN:

Menu > System > System PIN Code > Enter Your PIN > Save

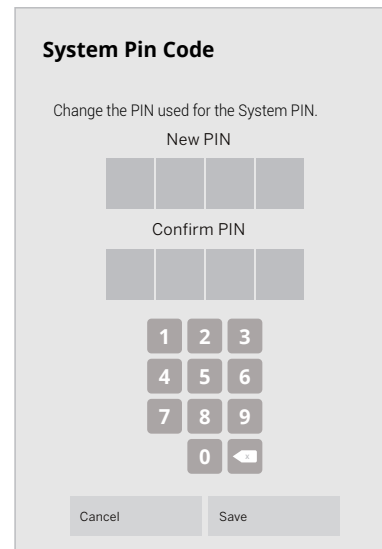

WARNING: You will need to enter your current PIN code the next time you access this menu or if you'd like to change your PIN.

Adjusting the CEC Settings

The CEC function on your TV enables you to control devices connected to an HDMI input with the VIZIO TV remote, without any programming

Menu > System > CEC

Select a setting and then press **OK**.

- **CEC** — To use CEC, you must select **Enable**.
- **Device Discovery** — To determine if your device is connected and supports CEC, select Device Discovery and then press **OK**.

CEC Audio Setup

Connect your audio device to the HDMI-1 (HDMI ARC) input on the TV. On your audio device, select the HDMI ARC input.

Using CEC, your VIZIO TV remote can control such features including (depending on specific device):

- Power On/Off
- Volume and mute
- Play and pause



WARNING: Not all HDMI devices support CEC. See your device's user manual for details.

Managing Mobile Devices

Your TV can be paired with a mobile device so you can easily control your TV across multiple devices.

To see a list of paired devices or unpair a device:

Menu > System > Mobile Devices

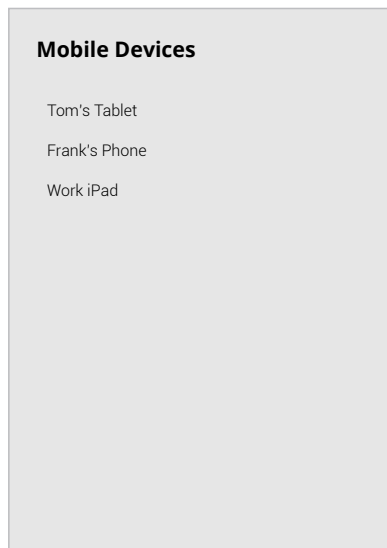

Highlight a device name to delete it and press **OK**.



Pairing the VIZIO Voice Remote

To pair your Voice Remote:

Menu > System > Voice Remote

Select Pair New Remote, then press and hold both the **MIC**  and **MUTE**  buttons for 5 seconds to launch pairing mode.

To use your successfully paired voice remote:

Press and hold the **MIC**  button while speaking a command.

To check for voice remote updates:

Menu > System > Voice Remote > Check for Update

To unpair a remote:

Menu > System > Voice Remote > Unpair Remote

USING THE ADMIN & PRIVACY MENU

You can use the TV's **Admin & Privacy** menu to restore the TV to its factory default settings as well as access other administrative settings.

Using the ADMIN & PRIVACY menu, you can:

- Force the system to power off and on
- View system information
- View a customer service support code
- Check for system updates
- Reset the TV to factory settings
- Enable or disable viewing data
- Personalize advertising choices
- View the VIZIO Privacy Policy
- Start or stop the store demo mode

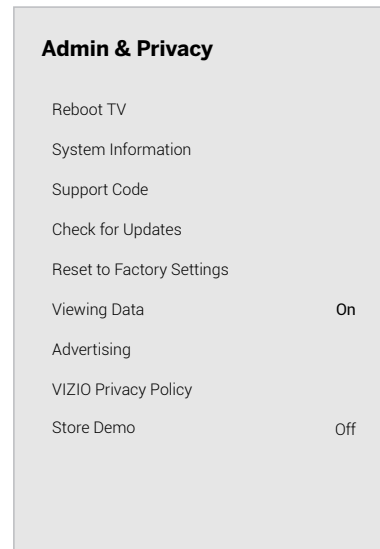

Performing a Reboot

A reboot forces the TV to turn off then on again.

To retrieve your reboot the TV:

Menu > Admin & Privacy > Reboot TV

Viewing System Information

To view technical data and status information about your TV and network connection:

Menu > Admin & Privacy > System Information

Accessing the Support Code

Retrieve a customer service support code/PIN or access basic TV information to assist in a customer service interaction.

To retrieve your support code:

Menu > Admin & Privacy > Support Code

Checking for System Updates

To check for a system update:

Menu > Admin & Privacy > Check for Updates

If an update is found, the TV will ask to confirm the update. If no update is found, the screen will note "The TV is up-to-date."

Restoring the TV to Factory Default Settings

All of the on-screen menu settings can be reset to the factory defaults.



WARNING: If you restore the TV to the factory default settings, all change you have made to the settings will be lost. This includes any wireless or picture settings.

To restore the TV to its factory default settings:

Menu > Admin & Privacy > Reset to Factory Settings

1. If you set a system PIN code, enter it now.
2. The TV displays, "Select Reset to restore all TV settings to factory defaults."
3. Highlight **Reset** and press **OK**.
4. Wait for the TV to turn off. The TV will turn back on shortly afterward and the setup process will begin.

Viewing Data

To turn viewing data on or off:

[Menu](#) > [Admin & Privacy](#) > [Viewing Data](#)

Use the **Left/Right Navigation** buttons to toggle from **On** or **Off**

About Viewing Data

WHAT IS VIEWING DATA AND HOW IS IT COLLECTED?

VIZIO Smart TVs have built-in Automated Content Recognition technology that can understand viewing behavior and usage including audio and video programming, ads, gaming content and OTT apps in real-time

Viewing Data is associated with IP address for the unit and a unique device number we assign. If available, we may associate Viewing Data with the VIZIO Account associated with the device, and email or other contact information (such as hashed/encrypted versions of your email address or other identifier).

We may use Viewing Data along with information from data brokers or advertisers, such as demographic data, smartphone location, web history, and purchasing history, and usage information such as how much time was spent viewing content.

WHO DO WE SHARE VIEWING DATA WITH?

We share Viewing Data with authorized data partners, by licensing Viewing Data to analytics companies, media companies, advertisers, ad agencies, and other ad tech companies who measure ad effectiveness or aid personalization of ads.

Our authorized cloud service providers may also store this data on and solely on our behalf and for no other purpose.

HOW IS VIEWING DATA USED?

Create or recommend more relevant programming on VIZIO services, channels, and on third party websites, mobile apps, platforms and devices. Improve our products and services. Tailor the advertising you see on your Smart TV or across various VIZIO and third party platforms or devices, including other devices associated with your IP Address, device ID, email address or VIZIO account on the basis of your Viewing Data. Measure and understand the reach, viewership, and effectiveness of advertising, and provide advertising analytics and reporting. Help our ad partners reach the desired audience and understand and improve their ad campaigns. For other marketing purposes, including sending you emails and text messages about products, events, promotions and offers from VIZIO, partners or advertisers (where you have given your separate consent to receive emails and text messages).

WHAT DOES THIS MEAN TO ME?

You can choose whether to enable the collection and usage of Viewing Data for these purposes now or at any time on your Device by directing your remote to:

[Settings](#) > [Menu](#) > [Admin & Privacy](#) > [Viewing Data](#)

You can turn off or reset various interest-based Advertising settings at:

[Settings](#) > [Menu](#) > [Admin & Privacy](#) > [Advertising](#)

More information about our Viewing Data and Advertising practices is available below, in our Privacy Policy, at vizio.com, or also available under:

[Settings](#) > [Menu](#) > [Admin & Privacy](#)

Managing Advertising Settings

Your advertising choices can be personalized.

Limited Ad Tracking

When enabled, TV Ad ID will not be passed or used for personalized ads on this device.

To turn on or off:

[Menu](#) > [Admin & Privacy](#) > [Advertising](#) > [Limited Ad Tracking](#)

Use the **Left/Right Navigation** buttons to toggle from **On** or **Off**.

Reset TV Advertiser ID

An Identifier for Advertising — can be reset to a new identifier at any time.

To reset the TV Advertiser ID:

[Menu](#) > [Admin & Privacy](#) > [Advertising](#) > [Reset TV Advertiser ID](#) > **OK**

Ad Replacement

Replaces Standard Ads with Personalized Ads in Linear TV.

To turn Ad Replacement on or off:

[Menu](#) > [Admin & Privacy](#) > [Advertising](#) > [Ad Replacement](#)

Use the **Left/Right Navigation** buttons to toggle from **On** or **Off**.

View VIZIO Privacy Policy

To view VIZIO Privacy Policy:

[Menu](#) > [Admin & Privacy](#) > [VIZIO Privacy Policy](#) > **OK**

Store Demo

To set to Off, Demo 1, or Demo 2:

[Menu](#) > [Admin & Privacy](#) > [Store Demo](#)

User Manual

To display the User Manual on the screen:

[Menu](#) > [Admin & Privacy](#) > [User Manual](#)

USING THE INFO WINDOW

After switching inputs or changing channels on the tuner, the Info window will display:

- TV name
- Current input or current tuner channel
- Picture resolution
- Picture aspect
- Audio type
- Network name
- Time

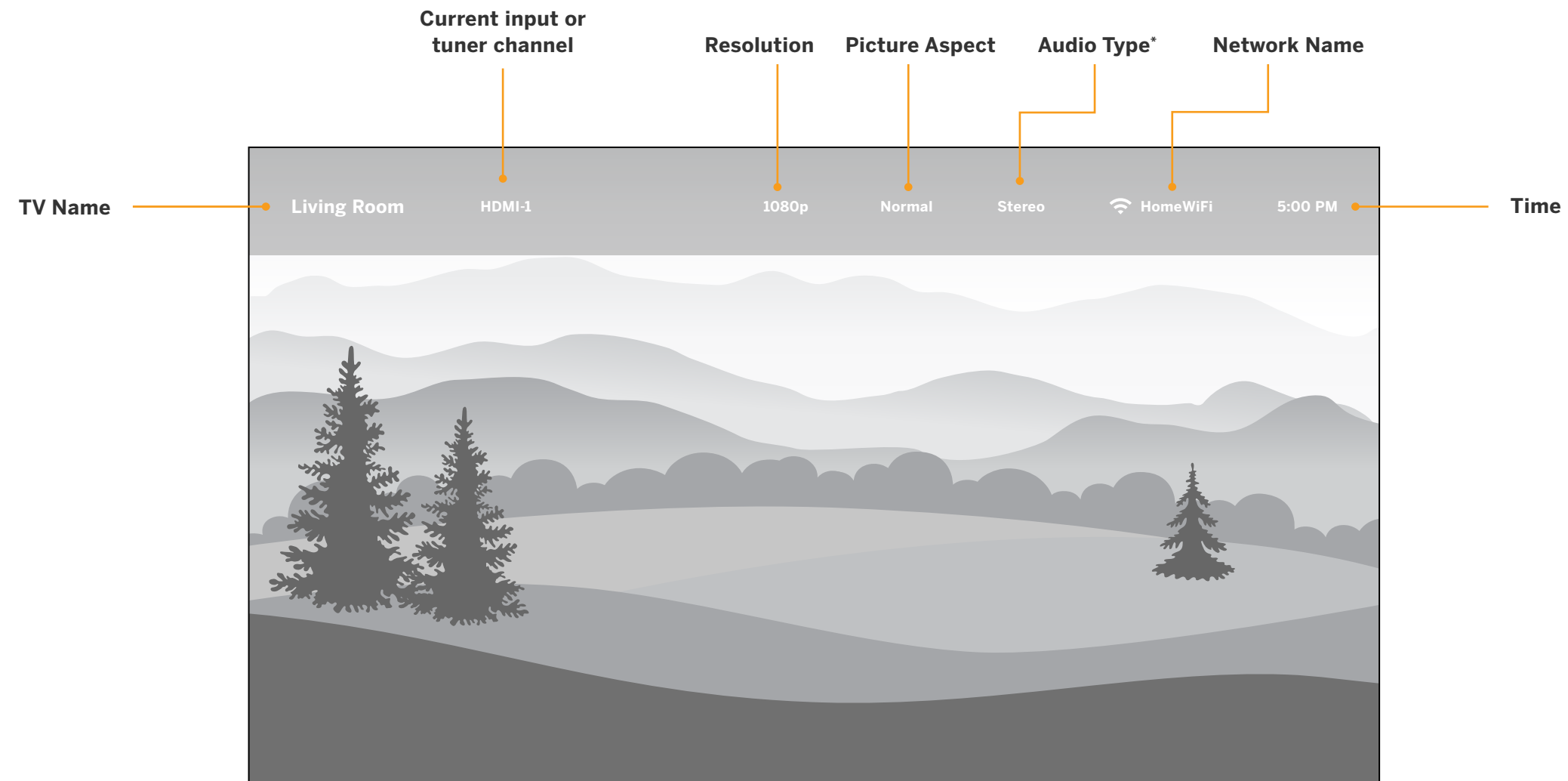

*When TV speakers are off and Dolby Atmos content is passed through the TV to a sound bar or other audio device, the Dolby Atmos icon  will display with "Audio Out."

VIZIO Smart TV Platform

What is the VIZIO Smart TV Platform?

The VIZIO Smart TV Platform lets you discover, stream, and control your content like never before! Access top apps, like Netflix, Disney+, and Hulu, by using the remote to easily browse and launch content directly from the home screen. The VIZIO Smart TV home screen makes finding something to watch easy and fun.

Launching the VIZIO Smart TV Platform

To begin streaming with the VIZIO Smart TV Platform:

- Press the **Home**  button on your remote.
- or—
- Select **SmartCast** from the list of inputs.

What you can do with the VIZIO Smart TV Platform

- Stream high quality entertainment.
- Launch top tier apps directly from the home screen.
- Access free channels to watch without a subscription through WatchFree+.
- Rearrange apps on your home screen to make it just the way you like it.
- Mirror your laptop or mobile device onto your TV through Apple Airplay or Chromecast built-in.



- Use Google Assistant, Siri, and Alexa-enabled devices for hands-free voice control.

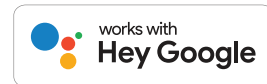

Controlling your TV with the VIZIO Mobile App

Download the VIZIO Mobile App and turn your smartphone into a remote to control and configure your TV.

With the VIZIO Mobile App, you can:

- Power on/off devices, play/pause content, and modify advanced settings, all from the palm of your hand.
- Easily enter text onto your TV/display from your mobile device using a full keyboard.
- Browse and discover movies, TV shows, music, live streams, and more, across multiple apps at once.
- Access a quick look at show ratings, synopsis, cast, crew, clips, and other details.

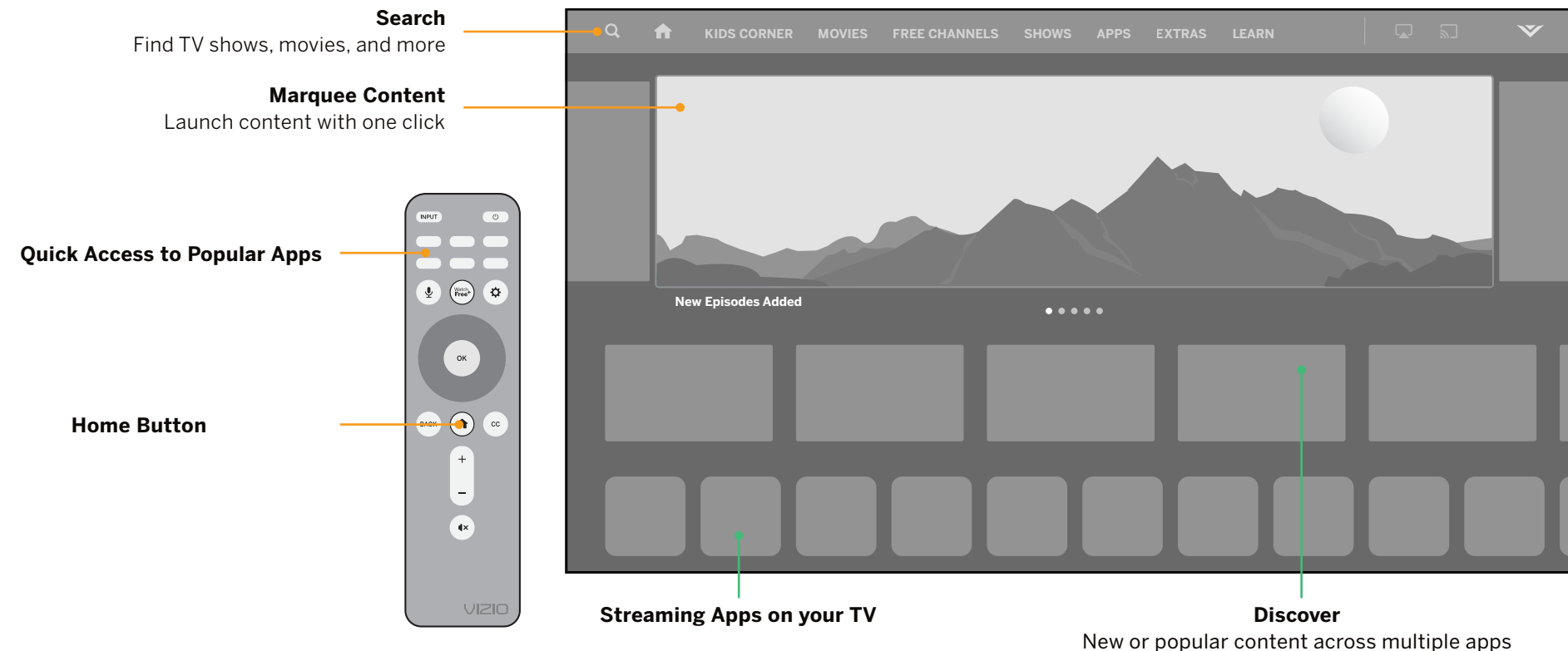

Scan to download.
Scan with your phone camera or QR reader.

vizio.com/smartcastapp



Visit www.vizio.com/smartcastapp for minimum requirements.

What is WatchFree+?

VIZIO WatchFree+ takes your cord-cutting entertainment experience one step further! With the simple press of a button, enjoy free streaming TV with hundreds of live TV channels to choose from – news, movies, sports, comedy, music and more. A built-in on-screen guide makes finding something to watch easier than ever.

And it's all FREE—no fees, no subscriptions, or logins.

What you can do with WatchFree+

- Stream hundreds of live TV channels absolutely free – news, movies, sports, comedy, music and more.
- Navigate through channels, organized by genre, with an intuitive on-screen guide.
- Watch the best of internet TV.
- No logins, subscriptions or transactions fees.

How to Launch WatchFree+

To launch and begin watching entertainment offered on WatchFree+:

- Press the **WatchFree+**  button on your remote.
- or—
- Select **WatchFree+** from the list of inputs or app row.

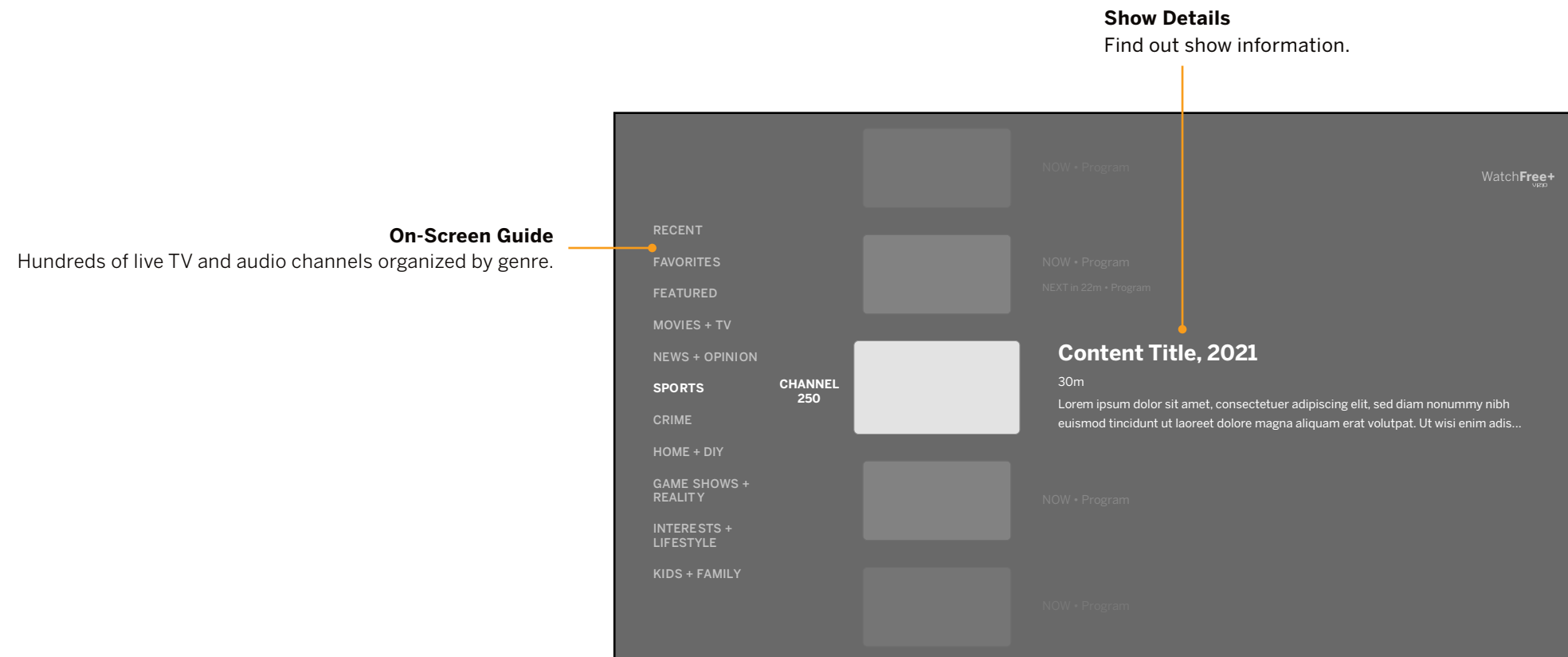

WatchFree+ Button

OK Button

Press the **OK** button to return to the WatchFree+ on-screen guide. Use the up/down Navigation buttons to scroll through the guide.

Playing USB Media

The USB Media Player allows you to connect a USB flash drive to your TV and play music, video, or photos.



Preparing Your USB Drive to Play USB Media

To display USB media, you must first save your videos onto a USB flash drive:

- The USB flash drive must be formatted as FAT32.
- Files on the USB flash drive must end in a supported file extension (.mp3, .jpg, etc).
- The player is not designed to play media from external hard drives, MP3 players, cameras, or smartphones.

Displaying USB Media

To display your USB media:

1. Connect your USB flash drive to the USB port on the side of the TV.
2. The TV will recognize the USB. Use the **Navigation** Keys on the remote to select the content you want to play.

—or—

3. Select **USB** from the bottom streaming icons on the SmartCast Home page.



TIP: You can display your photos in Fullscreen. Select the photo, press **OK**, then highlight **Fullscreen** and press **OK**.

Removing the USB Drive from the TV

To safely remove your USB flash drive from the TV:

1. Turn the TV **off**.
2. Disconnect your USB flash drive from the USB port on the side of the TV.



WARNING: Do not remove the USB drive while the TV is on. Doing so may damage the drive.

Note: The image shown here is for illustrative purposes only and may be subject to change. The actual number of ports and their locations may vary, depending on the model.

Playing USB Media: Music

Back Button
Highlight this button and press **OK** to return to the previous screen.

Connected Sources
Displays connected USB devices.

Current Folder

Playback Control

Toggle Music/Photos

Sort by Album/Artist/Track

View All or View Folders
Toggle between viewing all content and only viewing folders.

Now Playing Information
Displays song title, album title, and other information.

Progress Bar
Displays the duration of the currently-playing song. The bar will lengthen as the song progresses.

Album Art
If included on the USB thumb drive and associated with your music, the album art will display here.

Folder Contents/Playlist
This area displays the contents of the currently selected folder. You can browse among files using the **Arrow** and **OK** buttons on the remote.

Page Information
If your USB thumb drive has more files than can be displayed on a single screen, the page number is displayed here.

VIZIO

Music

USB1: MyFlashDrive

My Music

MyFlashDrive\Audio\root\My Music

#	Track	Album	Artist	Duration
1	Starry Summer	Summer	JCheesy	2:42
2	Summer Nights	Summer	DJ Sunset	3:11
3	Mango Dream	Beach Mix	Ana Banana	8:46
4	Crystal Waters	Beach Mix	The Dash	4:21
5	Smooth Waves	Breezy Mix	Rio Steve	7:58

Page 1 of 1

Playing USB Media: Video

Back Button
Highlight this button and press **OK** to return to the previous screen.

Connected Sources
Displays connected USB devices.

Current Folder

Preview Window

Folder Contents/Playlist
This area displays the contents of the currently selected folder. You can browse among files using the **Arrow** and **OK** buttons on the remote.

Sort by Date or File Name

View All or View Folders
Toggle between viewing all content and only viewing folders.

Play once or continuously

Page Information
If your USB thumb drive has more files than can be displayed on a single screen, the page number is displayed here.

VIZIO
Video
USB1: MyFlashDrive
My Videos
File Name: Family Vacation - California
Resolution: 3840 x 2160
Audio: AAC
Press OK for full screen.
00:03:22 00:23:43
MyFlashDrive\Video\root\My Videos
File Date Duration
1 Family Vacation - California - 00:23:43
2 28th Birthday Party - 00:38:18
3 Korea 2019 - 00:41:08
4 Sunny's Graduation - 00:25:32
Sort: Date New-Old
View: Folders
Play Once
Page 1 of 1

Playing USB Media: Photo

Back Button
Highlight this button and press **OK** to return to the previous screen.

Back Button
Highlight and press **OK** to return to left column.

Current Folder
Displays the folder path.

Connected Sources
Displays connected USB devices.

Current Folder

Start Fullscreen Slideshow

Sort by Date or File Name

View Thumbnails/Folders

Adjust Slideshow Settings

View Music Files

Folder Contents/Playlist
This area displays the contents of the currently selected folder. You can browse among files using the **Arrow** and **OK** buttons on the remote.

Photo Information
Displays the name, resolution, and file size of the selected photo.

Page Information
If your USB thumb drive has more files than can be displayed on a single screen, the page number is displayed here.

The screenshot shows the VIZIO interface with the following elements:

- Top bar: VIZIO logo, navigation arrows, and breadcrumb path: Photo > VIZIO_2GB\Photo\root
- Left sidebar: Connected Sources (USB1: MyFlashDrive), Current Folder (root), Start Slideshow, Sort: Name A-Z, View: Thumbnails, Settings, Browse Music.
- Main area: A 3x3 grid of photo thumbnails labeled A.jpg through I.jpg.
- Bottom left: Photo information for 'D 1920x1080' (Resolution: 1920x1080, Size: 1607270KB).
- Bottom center: Page 1 of 1.

Help Topics

The remote is not responding.

- Make sure the batteries are properly inserted matching the - and + symbols.
- Replace the batteries with fresh ones.

The TV displays “No Signal.”

- Look behind your TV to see where your device is connected. There will be a name next to the port you are using.
 - Make sure your device is powered on.
 - Press the **INPUT** button on the TV remote control and choose the port your device is connected to.
- If you are using cable TV or antenna connected directly to the TV, scan for channels. See *Scanning for TV Channels on page 23*.

There is no power..

- Ensure the power cable is securely attached to the TV and outlet. (Some models do not have a detachable power cable).
- Ensure the outlet the TV is connected to is working. You may want to connect another device to the outlet to ensure the devices are receiving power.
- Press the **Power/Standby** button on the remote or on the bottom of the TV to turn the TV on.

The power is on, but there is no image on the screen.

- Ensure all devices are connected securely and correctly. See your device's user manual for details.
- Ensure your TV is powering on. When your TV powers on, a light on the remote sensor will turn on. See *Front Panel on page 7*.
- Press the **MENU** key on your remote control. If you can see the menu, try to adjust Brightness, Contrast, or Backlight. See *Adjusting the Picture Settings on page 15*.
- Press the **INPUT** button on the remote to select a different input source.

The sound is flat or dialog is not audible.

- Turn off Volume Leveling. See *Adjusting the Audio Settings on page 21*.

How do I stream apps like Netflix to my VIZIO SmartCast TV?

- Popular apps are located on the SmartCast Home screen, so you can simply navigate to the app row on your SmartCast TV to start streaming.
- You can also use Apple AirPlay 2 or Chromecast built-in™ to stream content from your device directly to your SmartCast TV. For more information, please visit:
 - VIZIO.com/Apple
 - VIZIO.com/Google

The colors on the TV don't look right.

- Adjust the Color and Tint settings in the Picture menu. See *Adjusting the Picture Settings on page 15*.
- Select a pre-set picture mode. VIZIO recommends selecting Calibrated.
- Check all cables to ensure they are securely attached.

The image quality is not good.

- Image quality can vary depending on personal preference and environmental factors like how much light is in a room. Your TV includes a variety of picture settings and preset picture modes that can be adjusted to calibrate this TV to your preference. See *Adjusting the Picture Settings on page 15*.

- Image quality can vary depending on what program you are watching, and what device or app you are using to watch it. For the best picture quality, VIZIO recommends watching HD or UHD content. You can contact your device manufacturer or app provider for more information about their video playback quality.
- For the best image quality, view high-definition programs using digital sources. Connect your devices with HDMI cables.
- If you are using an antenna, the signal strength of the channel may be low. Ensure your antenna is connected securely to the TV and move the antenna around the room or close to a window for the best signal.

The picture is distorted.

- Move the TV away from electrical appliances, cars, and fluorescent lights.
- Ensure all cables are securely attached.

The TV image does not cover the entire screen.

- If you are using TV, AV, or Component with 480i input, go to **Menu > Picture > Picture Aspect** to adjust the Aspect Ratio.

The TV has pixels (dots) that are always dark.

- Your HD TV is precision-manufactured using an extremely high level of technology. However, sometimes pixels may not display correctly. These types of occurrences are inherent to this type of product and do not constitute a defective product.

The buttons on the remote aren't working.

- Ensure you are only pressing one button at a time.
- Point the remote directly at the TV when pressing a button.
- Replace the remote batteries with new ones. See *Replacing the Batteries on page 11*. (Batteries not supplied)
- Remove any obstacles that may be blocking the remote sensor on the TV.

There is no sound.

- Press Volume Up on the remote control.
- Press the **MUTE** button on the remote to ensure mute is off.
- Check the audio settings to ensure your TV speakers are set to On. See *Adjusting the Audio Settings on page 21*.
- Check the audio connections of external devices (Blu-ray player, game console, cable/satellite box) that are connected to the TV.
- If you are using an antenna, the signal strength of the channel may be low. Ensure your antenna is connected securely to the TV and move the antenna around the room or close to a window for the best signal.
- Set eARC to Off and use ARC mode.

How do I download the VIZIO SmartCast Mobile App?

- Make sure your phone or tablet is connected to a Wi-Fi network. Open a browser on your phone or tablet.
- Navigate to vizio.com/smartcastapp and follow the on-screen instructions to download the VIZIO SmartCast Mobile App.

How do I change the Inputs?

- Press the **INPUT** button on the back of the TV to cycle through the Inputs.
- Press the **INPUT** button on the basic remote to cycle through the Inputs.
- Make sure the VIZIO SmartCast Mobile app is installed on your phone or tablet. Open the VIZIO SmartCast Mobile app. Tap on the Device list and select your TV. Tap on the Input key and select the Input of your choice.

How do I connect to my Wi-Fi network?

- On your TV remote, press the **MENU** button then go to Network > Select your Wi-Fi name > Enter password

How do I exit Demo Mode?

- Press and hold the **INPUT** button on the back of the TV to exit the demo mode.

How do I watch Cable/Antenna TV channels?

- If you subscribe to cable or satellite, simply connect an HDMI cable (not included) to the receiver.
- If you use external antennas to watch local broadcast channels, use a coaxial cable to connect.

Some of my Channels are missing.

- Press the **MENU** button on your TV remote and select the channels option. Then select Find Channels.
- Open the VIZIO SmartCast Mobile app on your phone or tablet.
- **Click on:** Menu Tab > SmartCast Devices > Your TV/Device Name > Channels > Find Channels.

How do I disable/enable Viewing Data?

- Press the **MENU** button on your remote and select ADMIN & PRIVACY. Then select Viewing Data to turn the feature on or off.

The television will not turn on using Alexa or Google Assistant.

- Ensure the television is in Quick Start Mode.
- Tap on Menu > System > Power Mode > Quick Start.

How do I know I am getting 4K resolution or HDR content such as Dolby Vision?

- As you are watching content on the television, press the **INFO** button on the remote or VIZIO SmartCast Mobile app. You will see the current resolution being displayed along with the version of video.
- HDR will show as a Dolby Vision icon, HDR10 or HLG.

Specifications

	V435M-K04	V505M-K09	V555M-K01	V585M-K01
Size	43"	50"	55"	58"
Viewable Area	42.5"	49.5"	54.5"	57.5"
PRODUCT DIMENSIONS				
Dimensions w/ Stand	37.7" W x 24.2" H x 9.4" D 957.58 x 620.26 x 238.76 mm	43.7" W 27.6" H x 9.7" D 1109.98 x 701.04 x 246.38 mm	48.35" W x 30.48" H x 10.9" D 1228 x 774.1 x 277 mm	50.66" W x 32.03" H x 10.9" D 1286.72 x 813.44 x 277 mm
Dimensions w/o Stand	37.7" W x 21.9" H x 2.6" D 957.58 x 556.26 x 66.04 mm	43.7" W x 25.2" H x 2.6" D 1109.98 x 640.08 x 66.04 mm	48.35" W x 28.07" H x 3.19" D 1228 x 713.1 x 80.9 mm	50.66" W x 29.68" H x 3.20" D 1286.72 x 753.76 x 81.4 mm
Weight w/ Stand	15.6 lb (7.07 kg)	19.1 lb (8.66 kg)	28.88 lb (13.1 kg)	31.35 lb (14.22 kg)
Weight w/o Stand	15.4 lb (6.99 kg)	18.81 lb (8.53 kg)	28.53 lb (12.94 kg)	31.02 lb (14.07 kg)
Mounting Screw Size	M4	M6	M6 x 14 mm	M6 x 14 mm
Hole Pattern	200 mm x 100 mm	200 mm x 200 mm	300 mm x 200 mm	300 mm x 200 mm
# of Screws (not included)	4	4	4	4
PICTURE QUALITY				
Maximum Resolution	3840 x 2160 (UHD)	3840 x 2160 (UHD)	3840 x 2160 (UHD)	3840 x 2160 (UHD)
LCD Backlight	Full Array LED	Full Array LED	Full Array LED	Full Array LED
Dynamic Motion Rate	DMR120	DMR120	DMR120	DMR120
VRR	40-60 Hz FreeSync	40-60 Hz FreeSync	40-60 Hz FreeSync	40-60 Hz FreeSync
INPUTS / OUTPUTS				
HDMI Inputs	3	3	3	3
Ethernet Input	1	1	1	1
RF Antenna Input	1	1	1	1
USB	1	1	1	1
Audio Output	HDMI eARC, Analog Stereo Out, Digital Optical	HDMI eARC, Analog Stereo Out, Digital Optical	HDMI eARC, Analog Stereo Out, Digital Optical	HDMI eARC, Analog Stereo Out, Digital Optical
OTHER				
Remote Control Type	Voice Remote	Voice Remote	Voice Remote	Voice Remote
Power Consumption	88 W	98 W	109.90 W	94.14 W
Standby Power	< 0.5 W	< 0.5 W	< 0.5 W	< 0.5 W
Voltage	120V	120V	120V	120V
Wi-Fi	Wi-Fi 6E Tri-Band	Wi-Fi 6E Tri-Band	Wi-Fi 6E Tri-Band	Wi-Fi 6E Tri-Band
OSD Language	English, French, Spanish	English, French, Spanish	English, French, Spanish	English, French, Spanish
Certification	UL, FCC Class B, HDMI (CEC, ARC), DTS:X, DTS Virtual X, Dolby Audio, Dolby Vision	UL, FCC Class B, HDMI (CEC, ARC), DTS:X, DTS Virtual X, Dolby Audio, Dolby Vision	UL, FCC Class B, HDMI (CEC, ARC), DTS:X, DTS Virtual X, Dolby Audio, Dolby Vision	UL, FCC Class B, HDMI (CEC, ARC), DTS:X, DTS Virtual X, Dolby Audio, Dolby Vision

Specifications

	V655M-K03	V655M-K04	V705M-K03	V755M-K03
Size	65"	65"	70"	75"
Viewable Area	64.5"	64.5"	69.5"	74.5"
PRODUCT DIMENSIONS				
Dimensions w/ Stand	56.9" W x 35.5" H x 12.0" D 1446.3 x 902.4 x 304.8 mm	56.9" W x 35.4" H x 12.6" D 1445.26 x 899.16 x 320.04 mm	61.1" W x 38.2" H x 13.1" D 1552.0 x 969.5 x 332.1 mm	65.7" W x 40.5" H x 13.3" D 1669.0 x 1027.7 x 336.7 mm
Dimensions w/o Stand	56.9" W x 32.7" H x 2.9" D 1446.3 x 831.2 x 73.3 mm	56.9" W x 32.6" H x 3.3" D 1445.26 x 828.04 x 83.82 mm	61.1" W x 35.4" H x 2.9" D 1552.0 x 898.5 x 73.9 mm	65.7" W x 37.7" H x 2.9" D 1669.0 x 956.4 x 73.9 mm
Weight w/ Stand	41.2 lb (18.7 kg)	37.6 lb (17.05 kg)	52.6 lb (23.9 kg)	61.7 lb (27.96 kg)
Weight w/o Stand	40.2 lb (18.2 kg)	36.78 lb (17.59 kg)	51.6 lb (23.4 kg)	60.4 lb (27.4 kg)
Mounting Screw Size	M6	M6	M6	M6
Hole Pattern	400 mm x 200 mm	400 mm x 200 mm	400 mm x 200 mm	400 mm x 200 mm
# of Screws (not included)	4	4	4	4
PICTURE QUALITY				
Maximum Resolution	3840 x 2160 (UHD)	3840 x 2160 (UHD)	3840 x 2160 (UHD)	3840 x 2160 (UHD)
LCD Backlight	Full Array LED	Full Array LED	Full Array LED	Full Array LED
Dynamic Motion Rate	DMR120	DMR120	DMR120	DMR120
VRR	40-60 Hz FreeSync	40-60 Hz FreeSync	40-60 Hz FreeSync	40-60 Hz FreeSync
INPUTS / OUTPUTS				
HDMI Inputs	3	3	3	3
Ethernet Input	1	1	1	1
RF Antenna Input	1	1	1	1
USB	1	1	1	1
Audio Output	HDMI eARC, Analog Stereo Out, Digital Optical	HDMI eARC, Analog Stereo Out, Digital Optical	HDMI eARC, Analog Stereo Out, Digital Optical	HDMI eARC, Analog Stereo Out, Digital Optical
OTHER				
Remote Control Type	Voice Remote	Voice Remote	Voice Remote	Voice Remote
Power Consumption	158 W	139.5 W	185 W	205 W
Standby Power	< 0.5 W	< 0.5 W	< 0.5 W	< 0.5 W
Voltage	120V	120V	120V	120V
Wi-Fi	Wi-Fi 6E Tri-Band	Wi-Fi 6E Tri-Band	Wi-Fi 6E Tri-Band	Wi-Fi 6E Tri-Band
OSD Language	English, French, Spanish	English, French, Spanish	English, French, Spanish	English, French, Spanish
Certification	UL, FCC Class B, HDMI (CEC, ARC), DTS:X, DTS Virtual X, Dolby Audio, Dolby Vision	UL, FCC Class B, HDMI (CEC, ARC), DTS:X, DTS Virtual X, Dolby Audio, Dolby Vision	UL, FCC Class B, HDMI (CEC, ARC), DTS:X, DTS Virtual X, Dolby Audio, Dolby Vision	UL, FCC Class B, HDMI (CEC, ARC), DTS:X, DTS Virtual X, Dolby Audio, Dolby Vision

Regulatory Information

FCC Class B Radio Interference Statement

This device complies with Part 15 of the FCC Rules. Operation is subject to the following two conditions: (1) this device may not cause harmful interference, and (2) this device must accept any interference received, including interference that may cause undesired operation.

NOTE: This equipment has been tested and found to comply with the limits for a Class B digital device, pursuant to Part 15 of the FCC Rules. These limits are designed to provide reasonable protection against harmful interference in a residential installation. This equipment generates, uses and can radiate radio frequency energy, and if not installed and used in accordance with the instructions, may cause harmful interference to radio communications. However, there is no guarantee that interference will not occur in a particular installation. If this equipment does cause harmful interference to radio or television reception, which can be determined by turning the equipment off and on, the user is encouraged to try to correct the interference by one or more of the following measures:

- Reorient or relocate the receiving antenna.
- Increase the separation between the equipment and receiver.
- Connect the equipment into an outlet on a circuit different from that to which the receiver is connected.
- Consult the dealer or an experienced radio/TV technician for help.

FCC Caution

Changes or modifications not expressly approved by the party responsible for compliance could void the user's authority to operate this equipment.

Notice

The changes or modifications not expressly approved by the party responsible for compliance could void the user's authority to operate the equipment.

Shielded interface cables and AC power cord, if any, must be used in order to comply with the emission limits.

The manufacturer is not responsible for any radio or TV interference caused by unauthorized modification to this equipment. It is the responsibilities of the user to correct such interference.

This transmitter must not be co-located or operating in conjunction with any other antenna or transmitter.

Operations in the 5GHz products are restricted to indoor usage only.

This equipment complies with FCC/ISED radiation exposure limits set forth for an uncontrolled environment. This equipment should be installed and operated with minimum distance 20cm between the radiator & your body.

Canada Notice for License-Exempt Radio Apparatus

This device complies with Industry Canada's license-exempt RSSs. Operation is subject to the following two conditions: (1) This device may not cause harmful interference, and (2) this device must accept any interference received, including interference that may cause undesired operation.

This device operates on a no-protection no-interference basis. Should the user seek to obtain protection from other radio services operating in the same TV bands, a radio license is required. Please consult Industry Canada's document CPC-2-1-28, Optional Licensing for Low-Power Radio Apparatus in the TV Bands, for details.

Cet appareil est conforme aux CNR exempts de licence d'Industrie Canada. Son fonctionnement est sujet aux deux conditions suivantes:

1. le dispositif ne doit pas produire de brouillage préjudiciable, et
2. ce dispositif doit accepter tout brouillage reçu, y compris un brouillage susceptible de provoquer un fonctionnement indésirable

Cet appareil fonctionne sur une base sans protection et sans interférence. Dans le cas où l'utilisateur cherche à obtenir de la protection des autres services de radio fonctionnant sur les mêmes bandes TV, aucune licence est requise. Veuillez consulter le document CPC-2-1-28 d'Industrie Canada, License optionnelle pour les appareils radio de faible puissance, pour plus de détails.

Industry Canada Class B emission compliance statement

This Class B digital apparatus complies with Canadian ICES-003. Cet appareil numérique de la classe B est conforme à la norme NMB-003 du Canada.

Legal Information

Software Licenses

All software is provided subject to a software license agreement(s) and you agree that you will be bound by such license agreement(s) in addition to these terms. Your use of this product is subject to VIZIO's privacy policy, which may be updated from time to time, and is available to view at vizio.com/privacy.

Export Regulations

Customer acknowledges that the VIZIO products, which include technology and software, are subject to customs and export control laws in the United States ("US"). The products may also be subject to the customs and export control laws and regulations of the country in which the products are manufactured and/or received.

Internet Connectivity and App Availability

Network conditions, environmental and other factors may negatively affect connectivity and the resulting video quality, if any. The applications and content of the applications pictured herein or described in accompanying documentation may only be available in certain countries or languages, may require additional fees or subscription charges, and may be subject to future updates, modifications or discontinuation without notice. VIZIO has no control over third party applications or content and assumes no responsibility for the availability or interruption of such applications or content. Additional third party terms, conditions and restrictions apply.

© 2022 VIZIO, Inc. All Rights Reserved.

This User Manual may not be copied in whole or in part without the written permission of VIZIO, Inc. VIZIO, Inc. has made reasonable efforts to ensure the accuracy of the information provided herein. All product specifications, functionality, features, configurations, performance, design and other product information described herein are subject to change without notice. VIZIO, Inc. is not responsible for typographical, technical, or descriptive errors. To review the most updated version of this User Manual and the associated Quick Start Guide, go to vizio.com.

VIZIO, the VIZIO logo, the V logo, VIZIO SmartCast, and other terms and phrases are trademarks or registered trademarks of VIZIO, Inc.

The terms HDMI, HDMI High-Definition Multimedia Interface, and the HDMI Logo are trademarks or registered trademarks of HDMI Licensing Administrator, Inc.

For DTS patents, see <http://patents.dts.com>. Manufactured under license from DTS, Inc. DTS, DTS:X, Virtual:X, the DTS:X logo are registered trademarks or trademarks of DTS, Inc. in the United States and other countries. © 2021 DTS, Inc. ALL RIGHTS RESERVED.

Dolby, Dolby Vision, Dolby Audio, and the double-D symbol are trademarks of Dolby Laboratories Licensing Corporation. Manufactured under license from Dolby Laboratories. Confidential unpublished works. Copyright © 1992-2021 Dolby Laboratories. All rights reserved.

Google, Google Play, and Chromecast Built-in are trademarks of Google LLC.

Amazon, Alexa and all related logos are trademarks of Amazon.com, Inc. or its affiliates.

Other names of companies, products, and services used in this User Manual may be trademarks, trade names or service marks of others and VIZIO, Inc. disclaims any interest in trademarks, trade names or service marks other than its own. Mention of non-VIZIO products is for informational purposes only.

App services featured on the included IR remote may vary and may not be available in all regions.

4K or HDR availability varies by app and may be subject to subscription fees, internet service, and device capabilities.

Battery Disposal



Caution: This product may be shipped with batteries. Do not dispose of batteries in a fire or with ordinary household waste. Batteries may explode and can cause damage. Replace batteries only with the same or equivalent type of battery recommended by VIZIO. The disposal of batteries may be regulated by your state. For more information on recycling or properly disposing of your batteries, please check with your state or go to vizio.com/environment.

Product Recycling

The disposal and recycling of consumer electronic products may be regulated by your state. Always properly dispose of your VIZIO products in accordance with local laws and regulations. VIZIO supports the proper recycling of our products. For information on how to properly recycle your VIZIO products and to learn more about consumer electronics recycling laws, please go to vizio.com/environment or call (800) 374-3473.

Packaging Disposal

VIZIO encourages the recycling of the packaging used for this product. Please break-down all boxes and recycle eligible materials according to local laws and regulations. For more information please go to vizio.com/environment or call (800) 374-3473.