

NINJA

“Recipe book is not included”



**AIR FRYER
OWNER'S GUIDE**
804109284A

IMPORTANT SAFEGUARDS

HOUSEHOLD USE ONLY • READ ALL INSTRUCTIONS BEFORE USE

Read all instructions before using your Ninja® Air Fryer.

When using electrical appliances, basic safety precautions should always be followed, including the following:

⚠ WARNING

- DO NOT** use an extension cord. A short power-supply cord is used to reduce the risk of children grabbing the cord or becoming entangled and to reduce the risk of people tripping over a longer cord.
- This appliance has a polarized plug (one blade is wider than the other). To reduce the risk of electric shock, this plug is intended to fit into a polarized outlet only one way. If the plug does not fit fully into the outlet, reverse the plug. If it still does not fit, contact a qualified electrician. **DO NOT** attempt to modify the plug in any way.
- To eliminate a choking hazard for young children, remove and discard the protective cover fitted on the power plug of this appliance.
- ALWAYS** ensure the appliance is properly assembled before use.
- DO NOT** touch hot surfaces. Appliance surfaces are hot during and after operation. To prevent burns or personal injury, **ALWAYS** use protective hot pads or insulated oven mitts and use available handles and knobs.
- Intended for countertop use only. **DO NOT** place the appliance near the edge of a countertop during operation. Ensure the surface is level, clean, and dry.
- DO NOT** place on or near a hot gas or electric burner or in a heated oven.
- Extreme caution must be used when moving an appliance containing hot oil or other hot liquids.
- To protect against electrical shock **DO NOT** immerse cord, plugs, or main unit housing in water or other liquid.
- Unplug from outlet when not in use and before cleaning. Allow to cool before putting on or taking off parts.
- Extreme caution must be used when the appliance contains hot food. Improper use may result in personal injury.
- Extreme caution must be used when moving an appliance containing hot oil or other hot liquids.
- DO NOT** use this appliance for deep-frying with oil.
- ALWAYS** ensure basket is properly closed before operating.
- DO NOT** allow young children to operate the appliance or use as a toy. Close supervision is necessary when any appliance is used near children.
- Regularly inspect the appliance and power cord. **DO NOT** use the appliance if there is damage to the power cord or plug. If the appliance malfunctions or has been damaged in any way, immediately stop use and call a Service Center.
- The use of accessory attachments not recommended or sold by SharkNinja may cause fire, electric shock, or injury.
- This appliance is for household use only. **DO NOT** use this appliance for anything other than its intended use. **DO NOT** use in moving vehicles or boats. **DO NOT** use outdoors. Misuse may cause injury.
- DO NOT** clean with abrasive cleaners, steel wool, or scouring pads.
- Spilled food can cause serious burns. Keep appliance and cord away from children. **DO NOT** let cord hang over edges of tables or counters or touch hot surfaces. **NEVER** use an outlet below counter, and **NEVER** use with an extension cord.
- To prevent food contact with the heating elements, **DO NOT** overfill the basket.
- DO NOT** cover the air intake vent or air outlet vent while unit is operating. Doing so will prevent even cooking and may damage the unit or cause it to overheat.
- The crisper plate becomes extremely hot during the cooking process. Avoid hot steam and air while removing the basket from the appliance. **ALWAYS** place plate on a heat-resistant surface after removing. **DO NOT** touch accessories during or immediately after cooking.
- NEVER** connect this appliance to an external timer switch or separate remote-control system.
- Should the unit emit black smoke, unplug immediately and wait for smoking to stop before removing the cooking basket.
- Let the appliance cool for approximately 30 minutes before handling, cleaning, or storing.
- When using this appliance, provide adequate space above and on all sides for air circulation.
- Make sure the unit is clean before using.
- Please refer to the Cleaning & Maintenance section for regular maintenance of the appliance.
- Outlet voltages can vary, affecting the performance of your product. To prevent possible illness, use a thermometer to check that your food is cooked to the temperatures recommended by the Food and Drug Administration.
- To disconnect, turn any control to “off”, then remove plug from wall outlet.

SAVE THESE INSTRUCTIONS

TECHNICAL SPECIFICATIONS

Voltage: 120V, 60Hz

PARTS & ACCESSORIES

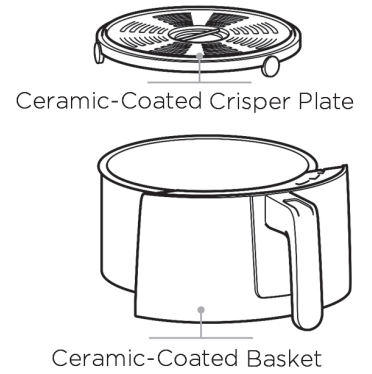

The image shown here is for illustrative purposes only and may be subject to change.

GETTING TO KNOW YOUR AIR FRYER

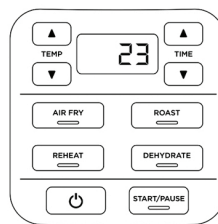

When setting time, the digital display shows HH:MM. Display currently reads 23 minutes.

FUNCTION BUTTONS

AIR FRY: Use this function to give your food crispiness and crunch with little to no oil.

ROAST: Use the unit as a roaster oven for tender meats, baked treats, and more.

DEHYDRATE: Dehydrate meats, fruits, and vegetables for healthy snacks.

REHEAT: Revive leftovers by gently warming them, leaving you with crispy results.

OPERATING BUTTONS

TEMP arrows: Use the up (▲) and down (▼) TEMP arrows to adjust the cook temperature before or during cooking.

TIME arrows: Use the up (▲) and down (▼) TIME arrows to adjust the cook time in any function.

START/PAUSE button: After selecting the time and temperature, start cooking by pressing the START/PAUSE button. You can stop cooking at any time by pressing this button again.

Power button: The Power button shuts off the unit and stops all cooking modes.

STANDBY MODE

After 10 minutes with no interaction with the control panel, the unit will enter standby mode. The Power button will be dimly lit.

BEFORE FIRST USE

- Remove and discard any packaging material.
- Remove all accessories from the package and read this manual carefully. Please pay particular attention to operational instructions, warnings, and important safeguards to avoid any injury or property damage.
- Wash the ceramic-coated basket and crisper plate in hot, soapy water, then rinse and dry thoroughly. **NEVER** clean the main unit in the dishwasher.

USING YOUR AIR FRYER

USING THE COOKING FUNCTIONS

To turn on the unit, first plug the power cord into a wall outlet. Press the power button.

Air Fry

- Ensure the crisper plate is in the basket.



- Press Air Fry button. The default temperature setting will display. Use the TEMP up and down arrows to set your desired temperature.



NOTE: It is recommended to let the unit preheat for 3 minutes before adding ingredients. If preheating, skip step 4, insert the basket, and press the START/PAUSE button to begin.

- Press the TIME up and down arrow buttons to set your desired cook time.



- Place ingredients on the crisper plate that is assembled in the basket. Insert the basket in the unit.



- Press START/PAUSE to begin cooking.



NOTE: To shake or toss ingredients during cooking, press START/PAUSE to pause cooking. Remove basket and shake it back and forth to toss ingredients. Reinsert basket and press START/PAUSE to resume cooking.



- When cooking is complete, the unit will beep and END will appear on the control panel display.

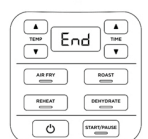

- Remove ingredients by dumping them out or by using oven mitts or silicone-tipped tongs/utensils.

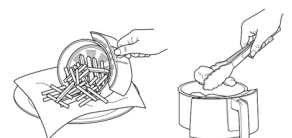

SharkNinja Operating LLC
US: Needham, MA 02494

Illustrations may differ from actual product. We are constantly striving to improve our products, therefore the specifications contained herein are subject to change without notice.

NINJA is a registered trademark of SharkNinja Operating LLC.

For SharkNinja U.S. Patent information, visit sharkninja.com/uspatents.

© 2018 SharkNinja Operating LLC
AF100Series_IB_MP_180619

USING YOUR AIR FRYER – CONT.

Roast

- 1 Ensure the crisper plate is in place if needed. If you are using a baking dish, the crisper plate is not needed.

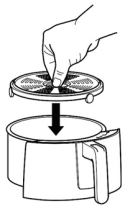

- 2 Press the ROAST button. The default temperature setting will display. Use the TEMP up and down arrow buttons to set your desired temperature.



NOTE: It is recommended to let the unit preheat for 3 minutes before adding ingredients. If preheating, skip step 4, insert the basket, and press the START/PAUSE button to begin.

- 3 Press the TIME up and down arrows to set your desired cook time.



Reheat

- 1 Ensure the crisper plate is in the basket.



- 2 Press the REHEAT button. The default temperature setting will display. Use the TEMP up and down arrow buttons set your desired temperature.



NOTE: It is recommended to let the unit preheat for 3 minutes before adding ingredients. If preheating, skip step 4, insert the basket, and press the START/PAUSE button to begin.

- 3 Press the TIME up and down arrows to set your desired cook time.



Dehydrate

- 1 Place your first layer of ingredients in the bottom of the basket. Then install the crisper plate inside the basket and set a second layer of ingredients on the crisper plate.

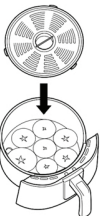

- 2 Insert the basket in the unit.
- 3 Press the DEHYDRATE button. The default temperature will display. Use the TEMP up and down arrow buttons to set your desired temperature.

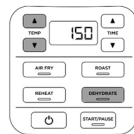

- 4 Add ingredients to the basket. Insert the basket in the unit.



- 5 Press START/PAUSE to begin cooking.



- 6 When cooking is complete, the unit will beep and END will appear on the control panel display.

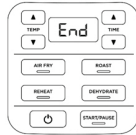

- 7 Remove ingredients by dumping them out or by using oven mitts or silicone-tipped tongs/utensils.

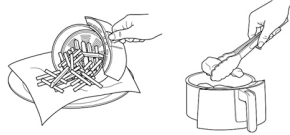

- 4 Add ingredients to the basket. Insert the basket in the unit.



- 5 Press the START/PAUSE button to begin cooking.



- 6 When cooking is complete, the unit will beep and END will appear on the control panel display.

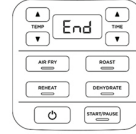

- 7 Remove ingredients by dumping them out or by using oven mitts or silicone-tipped tongs/utensils.

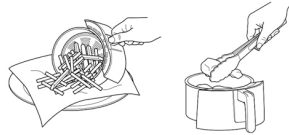

- 4 Press the TIME up and down arrow buttons to set your desired cook time.



- 5 Press the START/PAUSE button to start dehydrating.



- 6 When dehydrating is complete, the unit will make a beep sound and END will appear on the control panel display.

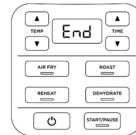

HELPFUL TIPS

- 1 For consistent browning, make sure ingredients are arranged in an even layer on the bottom of the basket with no overlapping. If ingredients are overlapping, make sure to shake them halfway through the set cook time.
- 2 Cook time and temperature can be adjusted at any time during cooking. Simply press the up and down TIME or TEMP arrows to adjust the time or temperature.
- 3 To convert recipes from your conventional oven, reduce the temperature of the Air Fryer by 25°F. Check food frequently to avoid overcooking.
- 4 We recommend 3 minutes of preheating. You can use the built-in timer to set a 3-minute countdown.
- 5 Occasionally, the fan from the air fryer will blow lightweight foods around. To alleviate this, secure foods (like the top slice of bread on a sandwich) with toothpicks.
- 6 The crisper plate elevates ingredients in the basket so air can circulate under and around them for even, crisp results.
- 7 After a cooking function is selected, you can press the START/PAUSE button to begin cooking immediately. The unit will run at the default temperature and time.
- 8 For best results, remove food immediately after the cook time is complete to avoid overcooking.
- 9 For best results with fresh vegetables and potatoes, use at least 1 tablespoon of oil. Add more oil as desired to achieve the preferred level of crispiness.
- 10 For best results, check progress throughout cooking, and remove food when desired level of brownness has been achieved. We recommend using an instant-read thermometer to monitor internal temp of proteins. After the cook time is complete remove food immediately to avoid overcooking.

TROUBLESHOOTING GUIDE

- **Why won't my temperature go any higher?**
The max temperature is 400°F.
- **How long does it take to preheat, and how will I know when it's done?**
We recommend 3 minutes of preheating. You can use the built-in timer to set a 3-minute countdown.
- **Should I add my ingredients before or after preheating?**
It is recommended to let the unit preheat for 3 minutes before adding ingredients.
- **Do I need to defrost frozen foods before air frying?**
It depends on the food! Follow package instructions.
- **How do I make the countdown pause?**
Press START/PAUSE.
- **Is the basket safe to put on my countertop?**
The basket will heat during cooking. Use caution when handling, and place on heat-safe surfaces only.
- **How do I know when to use the crisper plate?**
Use the crisper plate when you want food to come out crispy. The crisper plate allows for food to be elevated in the basket allowing for air to go under the plate and evenly crisp ingredients.
- **My food didn't cook.**
Make sure the basket is fully inserted during cooking. For consistent browning, make sure ingredients are arranged in an even layer on the bottom of the basket with no overlapping. Shake loose ingredients for even crispiness. Cook time and temperature can be adjusted at any time during cooking. Simply press the up and down TIME or TEMP arrows to adjust the time or temperature.
- **My food is burned.**
For best results, check progress throughout cooking, and remove food when desired level of brownness has been achieved. Remove food immediately after the cook time is complete to avoid overcooking.
- **Why is my food blowing around when air frying?**
Occasionally, the fan from the air fryer will blow lightweight foods around. To alleviate this, secure foods (like the top slice of bread on a sandwich) with toothpicks.
- **Can I air fry wet battered ingredients?**
Yes, but use the proper breading technique. It is important to coat foods first with flour, then with egg, and then with bread crumbs. Be sure to press the bread crumbs onto the food with your hands. Because the air fryer has a powerful fan as part of its mechanism, breading can sometimes be blown off. Pressing the bread crumbs firmly on will help them adhere.
- **The unit is beeping.**
Your food is done cooking.
- **The screen went black.**
The unit is in standby mode. Press the power button to turn it back on.
- **An "E" message appears on display screen.**
The unit is not functioning properly. Please call a service center.

REFURBISHED PRODUCT LIMITED NINETY DAYS WARRANTY

The **Refurbished Product Service Center** offers the following WARRANTY to the ORIGINAL purchaser of a product which we have refurbished.

This product that has been refurbished is warranted against any electronic or mechanical defects for a period of NINETY DAYS from the date of the original purchase by the consumer. Since this unit was sold as a refurbished item, the warranty does not apply to any cosmetic appearance items such as scratches. Should a defect occur, the **Refurbished Product Service Center** will repair or, at its option, replace defective unit/parts with new or rebuilt materials without charge for either parts or labor. Replacement unit/parts will be warranted for the remaining portion of the original warranty period.

This warranty does not cover installation or damage from accident, misuse, abuse, improper wiring, incorrect voltage, operating the unit against the instructions in the owner's manual or any product which has been opened, altered, or tampered with.

This warranty does not cover costs for removal and or installation of the unit for repair. Under no circumstances shall the service center be liable for any special, incidental or consequential damages or for any other expenses incurred by reason of use or sale of this product. This warranty is in lieu of any other warranties expressed or implied warranty of merchantability of fitness for particular use or otherwise.

This warranty gives the consumer specific legal rights and they may also have other rights which vary from State to State. Some States do not follow the exclusion or limitation of incidental or consequential damages, hence the above exclusion and limitations may not apply.

Refurbished Product Service Center
13225 Marquardt Avenue Santa Fe Springs, CA 90670.

WARRANTY REPAIR INFORMATION

If you need service on your unit and this product requires repair during the 90 days warranty period; please go to www.ConsumerServiceRefurbish.com or call the **Refurbished Product Service Center** at 562-946-3531 to obtain the required return authorization (RA) number. Pack the unit properly (the original carton is ideal for this purpose) along with a copy of your purchase receipt and a letter describing the problem. Send the unit freight prepaid and insured to:

Refurbished Product Service Center,
Att: Customer Service Department 13225 Marquardt Avenue Santa Fe Springs, CA 90670

Your unit will be promptly repaired and returned to you. We will refuse to accept delivery of the returned unit unless the assigned RA number appears on the outside of the shipping carton.

Owner's Information
(Keep for your permanent records)

NAME: _____

ADDRESS: _____

CITY: _____ STATE: _____ ZIP CODE: _____

PHONE: _____ E-MAIL: _____

MODEL: _____ SERIAL NO.: _____

CLEANING & MAINTENANCE

Cleaning Your Air Fryer

The unit should be cleaned thoroughly after every use.

- 1 Unplug the unit from the wall outlet before cleaning.

NOTE: NEVER immerse the main unit in water or any other liquid. **NEVER** clean the main unit in a dishwasher.

- 2 To clean the main unit and the control panel, wipe them clean with a damp cloth.

- 3 The basket, crisper plate, and any accessories can be washed in the dishwasher.

- 4 If food residue is stuck on the crisper plate or basket, place them in a sink filled with warm, soapy water and allow to soak.

- 5 Air-dry or towel-dry all parts after use.

- 6 Clean the heating element with a cleaning brush to remove any food residues.

