



ESPRESSO & COFFEE BARISTA SYSTEM

Recipe book is not included.

814100063

IMPORTANT SAFEGUARDS

READ ALL INSTRUCTIONS BEFORE USE • HOUSEHOLD USE ONLY

Read all instructions before using your NINJA ESPRESSO & COFFEE BARISTA SYSTEM

When using electrical appliances, basic safety precautions should always be followed, including the following:

WARNING

To reduce the risk of fire, electric shock, serious injury, death, or damage when using this appliance, follow these basic safety precautions.

General Precautions

- To eliminate a choking hazard for young children, discard all packaging materials immediately upon unpacking.
 - This appliance can be used by persons with reduced physical, sensory or mental capabilities or lack of experience and knowledge if they have been given supervision or instruction concerning use of the appliance in a safe way and understand the hazards involved.
 - To reduce the risk of electric shock, this appliance has a polarized plug (one blade is wider than the other). As a safety feature, this plug will fit into a polarized outlet only one way. If the plug does not fit fully into the outlet, reverse the plug. If it still does not fit, contact a qualified electrician. **DO NOT** force into outlet or try to modify to fit.
 - Keep the appliance and its cord out of reach of children. **DO NOT** allow the appliance to play or be used by children. Close supervision is necessary when used near children.
 - To protect against fire, electric shock, and injury to persons, **DO NOT** immerse cord, plugs, or body of machine in water or other liquid.
 - NEVER** carry the appliance by the power cord or pull it to disconnect from electrical socket; instead grasp the plug and pull to disconnect.
 - DO NOT** operate any appliance with a damaged cord or plug, or after the appliance malfunctions, or has been dropped or damaged in any manner. Contact SharkNinja Operating LLC for service.
 - For household and countertop use only. **DO NOT** let the power cord hang over the edge or touch hot surfaces such as the stove.
 - NEVER** use socket below counter.
 - To avoid risk of fire, electrical shock, or damage to the brewer, **DO NOT** use brewer in an appliance garage or under a wall cabinet.
 - Unplug from outlet when either the appliance or display clock is not in use, and before cleaning.
 - Turn off and allow to cool before putting on or taking off parts, and before cleaning the appliance.
- Operating Notice**
To disconnect, turn any control to "off", then remove plug from wall outlet.
- The use of an accessory not recommended by the manufacturer may create an overflow condition and scalding hazard, or result in fire, electric shock, or personal injury.
 - ALWAYS** use appliance on a clean, dry, level surface.
 - DO NOT** place on or near a hot gas or electric burner or in a heated oven.
 - DO NOT** use this appliance for anything other than its intended use.
 - DO NOT** use outdoors.
 - DO NOT** touch hot surfaces. Use handles or knobs.
 - To avoid contact with steam and hot surfaces, **DO NOT** reach across top of brewer to froth.
 - ALWAYS** place a vessel, carafe or cup beneath the brew basket to receive the brewed coffee.

- DO NOT** open brew chambers during brew cycle and cleaning cycle. Scalding may occur.
 - DO NOT** remove the vessel, carafe or cup while the appliance is running without the Drip Stop in the closed position. Return the vessel, carafe or cup quickly and open the Drip Stop to continue the brew.
 - DO NOT** fill water reservoir with anything other than water, as other liquids may damage your brewer.
 - DO NOT** overfill the water reservoir. Fill water only to the Full line.
 - Keep lid on water reservoir when brewing.
 - DO NOT** run the appliance without water.
 - DO NOT** brew ground coffee without a #4 paper cone filter or a permanent filter installed in the brew basket.
 - Exceeding maximum Coffee Measurement Chart capacity may cause overflow. **DO NOT** use fine or espresso ground coffee.
 - DO NOT** put fingers under coffee outlet, risk of scalding. **DO NOT** put fingers into capsule compartment or the capsule shaft. Danger of injury.
 - Only use capsules/pods intended for this appliance. If the capsule/pod does not fit, do not force it into the appliance.
- Carafe**
- The carafe is designed for use with this appliance only. **DO NOT** place carafe on or near a hot gas or electrical burner, or in a heated oven.
 - DO NOT** use a cracked or scratched carafe or a carafe that has a loose or weakened handle.
 - DO NOT** place carafe in microwave.
 - DO NOT** drink directly from the carafe. Liquid from the carafe may be very hot.
 - DO NOT** use the carafe to store food when not in use.
 - Ensure the carafe is completely empty before starting a cleaning or brewing cycle. Starting a cycle with water, coffee, or tea in the carafe will cause an overflow.
 - DO NOT** clean carafe with abrasive cleaners, steel wool pads, or other abrasive materials.
 - DO NOT** set a hot carafe on a wet or cold surface.
 - DO NOT** expose carafe to extreme temperature changes.
- Care & Maintenance**
- Allow the appliance to cool before removing any parts and before cleaning.
 - To prevent illness from bacterial growth in the appliance, follow all cleaning instructions in the Care & Maintenance section of this Owner's Guide.
 - Clean the system on a weekly basis.
 - If the product is not operating properly, visit ninjakitchen.com or contact SharkNinja Operating LLC for examination, repair, or adjustment.
 - Cleaning and user maintenance shall not be made by children.
- Cord Statement**
- A short power-supply cord is provided to reduce the risks resulting from becoming entangled in or tripping over a longer cord.
 - DO NOT** use extension cords with this product.

WARNING
Risk of fire or electric shock
Do not remove bottom cover.

- Indicates to read and review instructions to understand operation and use of product.
- Indicates the presence of a hazard that can cause personal injury, death or substantial property damage if the warning included with this symbol is ignored.
- Take care to avoid contact with hot surface. Always use hand protection to avoid burns.
- For indoor and household use only.

READ AND SAVE THESE INSTRUCTIONS

PARTS

- | | | |
|---|------------------------------------|---------------------------------------|
| A Brewer (Power cord not shown) | G Adjustable Cup Tray | M Brew-Through Lid |
| B 60 oz. Removable Water Reservoir | H Capsule Bin | N Ninja® Glass Carafe |
| C Removable Water Reservoir Lid | I Brew Basket | O Ninja Smart Scoop™ |
| D Lever | J Single-Serve Cup Platform | P Intelligent Warming Plate |
| E Flip Top Lid | K Control Panel | S Drip Stop |
| F Cup Tray Base | L Frother Whisk | T Capsule Clean Cycle Platform |

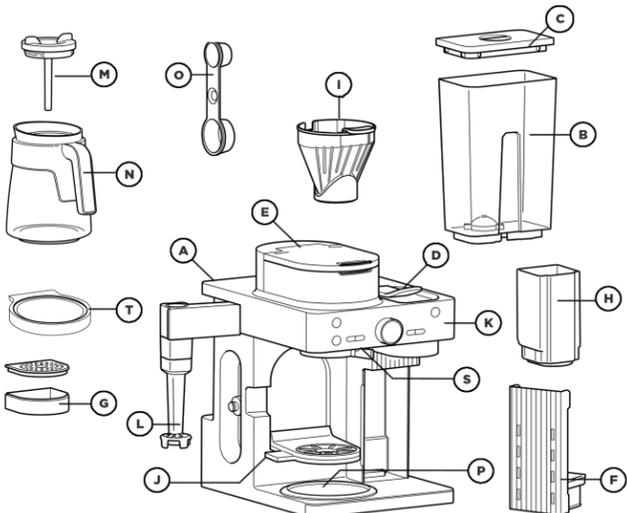

NOTE: Accessories may vary depending on the model. The images shown here are for illustrative purposes only and may be subject to change.

USING THE CONTROL PANEL

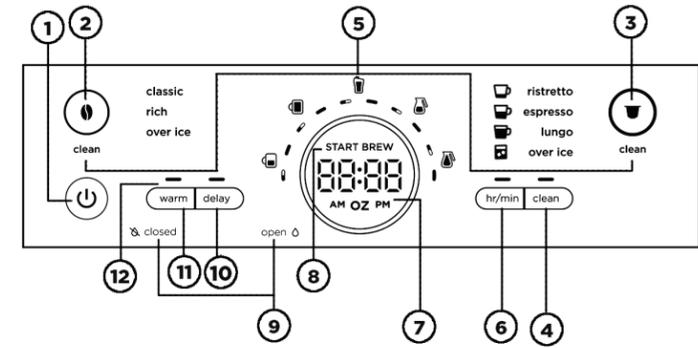

- Power Button
- Grounds Button
- Capsule Button
- Intelligent Clean Cycle Button
- Intelligent Clean Cycle Indicator
- Hour/Minute Button
- Programmable Digital Clock and ounce Display
- Dial/Start Brew Button
- Drip Stop Indicator
- Delay Brew Button
- Keep Warm Button
- Keep Warm Indicator

NOTE: Functions vary by model.

The actual descriptions of control panel and their locations may vary, depending on the model.

PREPARING FOR USE

SETTING THE CLOCK

- When the brewer is plugged in, the clock display and HR/MIN will begin to flash.
- Use the Dial to select the correct hour. Then, press the HR/MIN button to toggle to minutes.
- Use the dial again to select the correct minute, and press the HR/MIN button to set the clock at the displayed time.

NOTE: At any time, you can set the clock by pressing the HR/MIN button and following steps 2-3.

NOTE: If you unplug the brewer or in the event of a power loss, you will need to reset the clock the next time the brewer is plugged in.

HIGH-ALTITUDE CALIBRATION BREW

Required for users in high-altitude areas. Not running the high-altitude calibration brew in a high-altitude area will result in excessive steaming during brewing.

Because water boils at a lower temperature at higher altitudes, running a calibration cycle before your first brew allows the brewer to detect the boiling point of water at your location. Running a calibration cycle will help deliver a consistent brew each time.

- Fill the water reservoir up to, but not exceeding, the Full line.
- Insert the brew basket and close the flip-top lid, then place an empty carafe on the base.
- Power on the unit and press the Grounds Button. Ensure the Drip Stop is set to the open position. Next, press and hold both Grounds Button and HR/MIN until you hear a confirmation sound.
- A calibration cycle will begin, and the display will count down until the altitude calibration is complete. When complete, the brewer will beep and display "End" on the dial. Discard the water in the carafe.

NOTE: This calibration is permanently saved and will not be lost if power is lost or brew is unplugged. Brewer can be recalibrated at any time if the altitude where it is being used changes.

BEFORE THE FIRST BREW

- Clean all accessories before your first brew.
- Plug the brewer in and turn it on by pressing the power button.
- Lift the water reservoir off of its base. Remove the reservoir lid. Add water up to, but not exceeding, the Full line. Return the water reservoir to the brewer. **DO NOT** fill the water reservoir with anything other than water, as other liquids may damage your brewer.

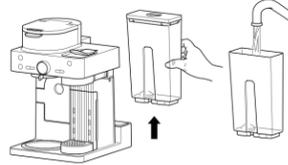

NOTE: We recommend using cool or room temperature water in the reservoir. **DO NOT** fill with hot or boiling water.

PRIMING THE CAPSULE SIDE

- Ensure the lever is closed. Do not insert a capsule.
- Center a vessel under the capsule brew outlet. Press the Capsule Button to select Lungo.
- To start, press START. When the cycle is complete, discard the water and rinse the vessel. Repeat this process 3 times. You are now ready to brew capsules.



PRIMING THE GROUND COFFEE SIDE

- Ensure the brew basket is fully installed in the unit and close the flip-top lid. Do not add coffee.
- Center the carafe with the brew-through lid installed below the grounds brew outlet. Press the Grounds Button to select Classic and turn the dial to select the Full Carafe size.
- To start, press START BREW. When the cycle is complete, discard the water and rinse the carafe. You are now ready to brew ground coffee.



USING THE NINJA® ESPRESSO & COFFEE BARISTA SYSTEM

IMPORTANT: This brewer is only compatible with Nespresso Original Capsules.

BREWING CAPSULES

- Fill reservoir to at least the Cup line.
- Lift lever completely and insert capsule. Close the lever.
- Place the vessel centered on the cup tray below the spout.

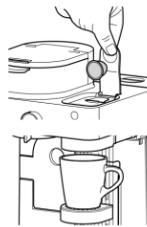

NOTE: Set the Adjustable Cup Tray height and set the vessel in the center of it to help prevent splashing. The cup tray may be removed for brewing into taller and wider vessels.

- Press the Capsule Button and select either Ristretto (not available on all models), Espresso, Lungo, or Over Ice Brew.

ristretto 25mL
Smaller, more concentrated serving with a sweeter, richer flavor.

espresso 40mL
Concentrated, flavorful serving of coffee.

TECHNICAL SPECIFICATIONS
Voltage: 120V~, 60Hz

lungo 110mL
A larger, less concentrated serving with a sharper flavor.

over ice 30mL
Specially designed to brew straight over ice and stand up to milk-based beverages.

Always fill your vessel to the top with ice cubes before brewing Over Ice.

- To start, press START BREW. The brewer will beep to signal the brew has started. The clock display may show "pre" indicating the brewer is preheating and will automatically start brewing once up to temperature. The progress bar around the dial will illuminate to indicate the status of the brew. When finished, the brewer will beep again, and End will appear on the display.
- To cancel the brew at any time, press the START BREW again or press the Power Button.

BREWING GROUND COFFEE

- To prepare for brewing, open the flip-top lid and ensure the brew basket is installed.
- Place a #4 paper cone filter or permanent filter (not included on all models, sold separately) in the brew basket. Use only a paper filter OR the permanent filter--not both.



NOTE: Fold the paper filter along the seams, open the top fully, and firmly press it into the brew basket, making sure it is fully seated.

NOTE: Paper filter not included

- Use the Ninja Smart Scoop and follow the measurements on the scoop or on the Coffee Measurement Chart to fill the filter. Close the flip-top lid.
- Place the empty vessel under the brew basket.

NOTE: If making a single cup, lower the Single-Serve Cup Platform and set your vessel in the center of it to help prevent splashing.

- Press the Grounds Button and select either Classic, Rich, or Over Ice Brew. Turn the dial to select the desired brew size.

BREW STYLES	
CLASSIC	Smooth, well-balanced flavor.
RICH	Richer than classic, with more intense flavor that stands up to milk, cream, or flavoring.
OVER ICE	Specially designed to brew hot over ice for freshly brewed iced coffee that is not watered down. Always fill your vessel to the top with ice cubes before brewing Over Ice.

NOTE: Rich Brew will use slightly less water and yield slightly less brewed coffee than Classic Brew. See Approximate Brew Volume chart for additional information.

- To start, press START BREW. The brewer will beep to signal the brew has started. The progress bar around the dial will illuminate to indicate the status of the brew. When finished, the brewer will beep again, and End will appear on the display.

NOTE: The brew cycle will begin, then pause for a short period before resuming. This process is used to evenly saturate the coffee grounds. This applies to all brew styles.

- To cancel the brew at any time, press START BREW again or press the Power Button.

BREW VOLUMES AND MEASUREMENTS

Each size and brew style produces a different amount of coffee to optimize strength and flavor.

NOTE: The coffee grounds will absorb some of the water that is brewed; this will cause slight variability in brew volumes than what is stated below.

APPROXIMATE BREW VOLUMES

Size	GROUNDS		
	Classic	Rich	Over Ice (filled with ice)
Sm Cup	8 oz.	7 oz.	8 oz.
Cup	10 oz.	8oz.	10 oz.
XL Cup	12 oz.	10 oz.	12 oz.
Travel	15 oz.	12 oz.	15 oz.
XL Travel	18 oz.	16 oz.	18 oz.
1/4 Carafe	28 oz.	26 oz.	28 oz.
1/2 Carafe	37 oz.	33 oz.	37 oz.
3/4 Carafe	46 oz.	41 oz.	46 oz.
Full Carafe	55 oz.	47 oz.	55 oz.

NOTE: There may be some water left in the reservoir after your brew. This is normal to keep the brewer from running out of water.

CAPSULES

Ristretto	Espresso	Lungo	Over Ice
25 mL	40 mL	110 mL	30 mL

MEASURING YOUR COFFEE GROUND

For best results, use the measurements on the Ninja Smart Scoop™ or in the chart to determine how much ground coffee to use for each brew size. Always use level scoops when measuring ground coffee. The amount of ground coffee for each size will remain the same for any brew type you select. For example, if you select **Cup** and **Classic**, you will use the same amount of coffee grounds as if you were to select **Cup** and **Over Ice**.

NOTE: Adjust to your preferred taste. More scoops result in stronger coffee but slightly lower volumes, fewer scoops result in weaker coffee and slightly higher volumes. Use fewer scoops of decaffeinated coffee to prevent overflow. Use a medium-sized grind if grinding whole beans. Grinding beans too finely may cause the brew basket to overflow.

COFFEE MEASUREMENT CHART

Serving Size	Ninja Smart Scoop	Tablespoons
Sm Cup	2-3 small scoops	2-3 tablespoons
Cup		
XL Cup	3-5 small scoops	3-5 tablespoons
Travel		
XL Travel	3-5 big scoops	6-10 tablespoons
1/4 Carafe		
1/2 Carafe	4-7 big scoops	8-14 tablespoons
3/4 Carafe		
Full Carafe		

INTELLIGENT WARMING PLATE

The Intelligent Warming Plate will automatically turn on during Classic or Rich brews when any carafe size is selected. The Intelligent Warming Plate is set to a specific temperature setpoint to avoid burning the coffee over time. To turn the warming plate on at any time, press the Grounds Button to select either Classic or Rich, turn the dial to one of the carafe sizes, and press the WARM button.



IMPORTANT: The  light on the base of the brewer will illuminate only when the warming plate is hot and will remain illuminated until the plate has cooled down.

TIME & TEMPERATURE ADJUSTMENT

You can adjust how long the Intelligent Warming Plate remains on (up to 4 hours) and/or set the temperature to Low, Medium, or High.

By default, the Intelligent Warming Plate is set to remain on for 2 hours and is set to medium. To change the time/temperature settings of the warming plate, follow these instructions:

- 1 Press and hold WARM until the clock begins to flash the current warming time.
- 2 Turn the dial to increase the time in 15-minute increments up to 4 hours or decrease the time to 0 hours. Press WARM or START BREW to set the new time.
- 3 Next, the clock will display the current warming plate temperature. To keep the same temperature, press WARM or START BREW. To change the temperature, turn the dial and press WARM or START BREW for the temperature to lock in. The unit will beep signifying that the time and temperature has been set.

NOTE: If you set the warming time to 0 hours, Keep Warm will not automatically activate during or after a carafe brew cycle, but you can still turn it on manually by pressing the WARM button.

NOTE: The time adjustment setting will be saved and will not reset when the brewer is unplugged or loses power.

SETTING THE DELAY BREW (Grounds Mode Only)

- 1 Plug the brewer in and turn it on by pressing the Power button.

NOTE: The clock will remain on even if the brewer is turned off. Ensure the brewer is powered on to set Delay Brew.

- 2 After filling the water reservoir and adding ground coffee to the filter, place the appropriate-size vessel under the brew basket.
- 3 Press the Grounds Button to enter grounds mode. Press DELAY. The clock will begin to flash "12:00" or the previous time set.

 delay

- 4 While the clock is flashing, turn the dial to adjust the hour. The AM or PM indicator will illuminate under the clock display as you are setting the desired time. Press START BREW to lock in the hour. Now, turn the dial to adjust the minute. Press START BREW to lock in your time.
- 5 Next, turn the dial to select the size that you would like to brew.
- 6 Press the Grounds button to choose your brew style.
- 7 Once the time, brew size, and brew style have been set, press the dial to activate. When activated, the brewer will beep and DELAY and your selected options will remain illuminated. To view your set delay brew time, press and hold the DELAY button. To cancel, press the DELAY button or power off the unit.

NOTE: The brewer must remain on for the Delay Brew function to work. **DO NOT** power off or unplug after setting Delay Brew. If the brewer is turned off or unplugged, delay brew will need to be reset.

NOTE: When delay brew is set, a grounds brew cannot be run until the delay brew has finished or has been canceled. A capsule brew may be run at any time up until 5 minutes before the preset brew time.

IMPORTANT: If you cancel the clean cycle, your brewer will not be properly descaled.

- 5 The clock will count down the remaining clean cycle time, which takes approximately 75 minutes to complete. The brewer will deliver a small amount of cleaning solution to distribute it through the system. It will then pause, deliver additional cleaning solution, and repeat this process for 75 minutes. The extended pauses allow for maximum cleaning and descaling.
- 6 Upon completion, the brewer will beep, the clock will display End, and the Intelligent Clean Cycle Indicator will turn off.

IMPORTANT: DO NOT remove the carafe at any time during the clean cycle.

- 7 Empty the contents of the carafe and place it under the brew basket. Clean the water reservoir with warm, soapy water to remove any cleaning solution that could affect the flavor of your coffee.
- 8 Fill the reservoir with fresh water up to, but not exceeding the Full line.
- 9 Flush the system by running a water-only Full Carafe Classic brew cycle. After the cycle is complete, discard the water and thoroughly clean the carafe and brew basket.

Descaling Capsules Side:

If typical capsules you brew are taking significantly longer time to brew, run a capsule clean cycle. If the clock is displaying "Add Wtr", ensure the water tank is filled and fully seated, then try again. If "Add Wtr" persists, try running a water-only brew with the lever closed. If "Add Wtr" still persists, run a capsule clean cycle.

- 1 Ensure the lever is closed and no capsule is inserted.



- 2 Remove the Adjustable Cup Tray.

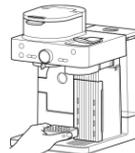

- 3 Place the Capsule Clean Cycle Platform on the front right base of the brewer.

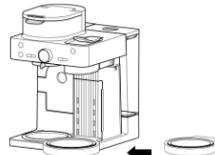

TROUBLESHOOTING GUIDE

Can't select Keep Warm.

- Keep Warm can be turned on manually by pressing WARM while in Grounds mode with Classic or Rich, and any Carafe size selected. If brewing a smaller size into the carafe, after the brew has finished select Classic or Rich and turn the dial to any carafe size, then press WARM.

There's sediment in my coffee.

- If using a permanent filter, this may be due to using finely ground coffee.
 - To reduce the amount of sediment in the brewed coffee, use a slightly coarser grind or use a paper filter.
- NOTE: DO NOT** use a paper filter in conjunction with a permanent filter, as water and/or coffee can back up and clog the filter basket.

Over Ice Brew is not cold.

- Ensure your cup, travel mug, or carafe is filled all the way to the top with ice cubes before brewing. Brewer will brew at elevated temperatures to lock in the best flavor, then the ice will cool the brewed coffee to the perfect temperature. Lower volumes of coffee will be brewed to account for some ice melt.

Coffee is too weak.

- For stronger coffee, use the Rich brew setting. For an even bolder flavor, you can add more coffee grounds to the filter.

Brew cycle is too slow.

- The brew time will vary based on size and brew style. Full carafe sizes and Rich brews will take longer to brew than single-serve and classic brews. The progress bar on the control panel will indicate brew status.

Cup or travel mug overflowed.

- Refer to the Approximate Brew Volumes chart.

Brew basket overflowed.

- The bottom of the brew basket may be clogged. This can happen with finely ground coffee or too many coffee grounds in the filter. Medium-grind coffee is recommended.
- Using both the permanent filter and a paper filter can cause grounds to clog and water to back up in the brew basket. Use only the permanent filter or a paper filter.
- Decaf coffee grounds absorb water differently, so use fewer scoops when using decaf.

There is water left in the reservoir.

- When the reservoir is filled to a specific size and then that size is brewed, there will be some water left in the reservoir. This is normal to ensure the reservoir does not run dry for the best performance of the pump and brew system.

Brewer is leaking.

- After removing the water reservoir, there may be a small amount of water in the reservoir valve. This can be easily removed with a dry cloth.
- If the leak is coming from above the brew basket, refer to "Brew basket overflowed."
- above. If the leaking is coming from below the brew basket, close the drip stop.
- If the leaking is coming from the capsule side, ensure the adjustable cup tray is in place to catch any excess drips.
- If the leak is coming from the bottom of the brewer, call a Service center.

Intelligent Clean Cycle Indicator is illuminating orange.

- Run a clean cycle. If you have recently completed a clean cycle, you may need to run another cycle to remove additional mineral buildup that occurs naturally over time and is common in hard-water areas. Make sure you are using vinegar or a descaling solution and follow the cleaning instructions.

Coffee is not hot enough.

- If brewing into the carafe, ensure Keep Warm is on. The Intelligent Warming Plate temperature can be adjusted between Low, Medium, and High (see Time & Temperature Adjustment.)
- Adding cold milk or creamer to coffee will effect the temperature.
- We recommend prewarming the cup with hot water before brewing.

Capsule doesn't fit / Capsule is getting crushed

- This brewer is only compatible with Original Capsules.
- Ensure the capsule is being inserted in the correct orientation as shown on the unit
- The Capsule Bin may be full. See how to remove Capsule Bin.

Brewer is loud

- This brewer uses a high pressure pump in order to evenly saturate and extract flavor of the capsules.

Lever not closing completely

- Empty the Capsule Bin. Ensure all used capsules are removed and no capsule is blocked.

Coffee is splattering.

- Some splatter is normal. Use the cup tray when possible to reduce the distance between the cup and the coffee outlet.

Water reservoir is unstable.

- Ensure the water reservoir is installed securely on the hook.

CLOCK DISPLAY MESSAGES:

End

- The brew cycle is complete.

PrE

- While brewing capsules, once START BREW has been pressed the clock display may show "PrE". This indicates the brewer is preheating and the brew will automatically start once the brewer is up to temperature.

Add Wtr

- Ensure water is in the reservoir. If the reservoir is empty, add fresh water to the reservoir and then press START BREW to resume the brew.

- If the reservoir is filled with water, remove and reseal the reservoir and then press START BREW to resume the brew.

- If brewing capsules, try removing the capsule and brewing again. If the issue persists, run a clean cycle on the capsule side following the instructions.

- If brewing grounds and the issue persists, contact a Service center.

CLn

- The system has detected that a clean cycle needs to be run immediately to remove calcium scale buildup in the heater. See 'Cleaning & Descaling Your Brewing System' for instructions.

STOP

- A brew cycle was cancelled.

ERROR MESSAGES:

Er

- If the clock displays "Er" and then a number (ex. "Er 03"), contact a Service center.

REFURBISHED PRODUCT LIMITED NINETY DAYS WARRANTY

The **Refurbished Product Service Center** offers the following WARRANTY to the ORIGINAL purchaser of a product which we have refurbished.

This product that has been refurbished is warranted against any electronic or mechanical defects for a period of NINETY DAYS from the date of the original purchase by the consumer. Since this unit was sold as a refurbished item, the warranty does not apply to any cosmetic appearance items such as scratches. Should a defect occur, the **Refurbished Product Service Center** will repair or, at its option, replace defective unit/parts with new or rebuilt materials without charge for either parts or labor. Replacement unit/parts will be warranted for the remaining portion of the original warranty period.

This warranty does not cover installation or damage from accident, misuse, abuse, improper wiring, incorrect voltage, operating the unit against the instructions in the owner's manual or any product which has been opened, altered, or tampered with.

This warranty does not cover costs for removal and or installation of the unit for repair. Under no circumstances shall the service center be liable for any special, incidental or consequential damages or for any other expenses incurred by reason of use or sale of this product. This warranty is in lieu of any other warranties expressed or implied warranty of merchantability of fitness for particular use or otherwise.

This warranty gives the consumer specific legal rights and they may also have other rights which vary from State to State. Some States do not follow the exclusion or limitation of incidental or consequential damages, hence the above exclusion and limitations may not apply.

Refurbished Product Service Center
13225 Marquardt Avenue Santa Fe Springs, CA 90670.

WARRANTY REPAIR INFORMATION

If you need service for your unit and this product requires repair during the 90 days warranty period; please go to www.ConsumerServiceRefurbish.com or call the **Refurbished Product Service Center** at 562-946-3531 to obtain the required return authorization (RA) number. Pack the unit properly (the original carton is ideal for this purpose) along with a copy of your purchase receipt and a letter describing the problem. Send the unit freight prepaid and insured to:

Refurbished Product Service Center,
Att: Customer Service Department 13225 Marquardt Avenue Santa Fe Springs, CA 90670

Your unit will be promptly repaired and returned to you. We will refuse to accept delivery of the returned unit unless the assigned RA number appears on the outside of the shipping carton.

Owner's Information (Keep for your permanent records)

NAME: _____

ADDRESS: _____

CITY: _____

STATE: _____

ZIP CODE: _____

PHONE: _____

E-MAIL: _____

MODEL: _____

SERIAL NO.: _____

NOTE:

In order to ensure the highest possible standard for refurbished items, all units are thoroughly inspected as part of the process. For this item, water may be used during the refurbishing process and so; you may notice some condensation in the water reservoir. It is recommended to rinse the water reservoir with fresh water prior to its first use.

USING THE DRIP STOP

The drip stop is used to close off the brew basket to prevent any coffee from dispensing. You will need to manually open and close the drip stop by moving the lever to your desired position. It can be closed and reopened at any point before, during, or after a brew.

If the Drip Stop is closed mid-brew the brewer will pause the brew, and after 30 seconds it will give you a friendly audible reminder to reopen the Drip Stop. After 5 minutes, the brew will be canceled.

NOTE: If the Drip Stop is closed before you begin a brew, the brewer will notify you with 3 beeps and the Drip Stop indicator will illuminate. Move the Drip Stop to the open position and press START BREW to begin your brew.

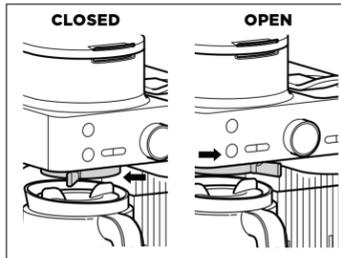

CLOSING THE DRIP STOP AFTER A BREW

When the brew cycle is complete, set the Drip Stop to the closed position to stop dripping from the brew basket.

NOTE: Remember to open the Drip Stop when you are ready to brew again. If you forget, your brewer will give you a friendly audible reminder.

INTEGRATED FROTHER

The Integrated Frother does not heat milk.

- 1 Add milk to your cup until it is about 1/3 full.
 - For cold froth, continue to Step 2.
 - For hot froth, microwave for 45-60 seconds.

NOTE: Frother does not heat liquid.



- 2 Swing the arm of the frother toward the front of the brewer. Install the frother whisk by twisting it to the right.

- 3 Hold the cup under the frother and submerge the whisk just below the surface of the milk. Press and hold the button on top of the frother and froth for 30-45 seconds.



- 4 Remove the frother whisk by twisting it to the left. Keep your cup below the whisk while you carry it to your sink or dishwasher for easy cleaning.



WARNING: To avoid contact with steam and hot surfaces. **DO NOT** reach across top of brewer to froth.

CLEANING & MAINTENANCE

CLEANING AFTER A BREW

Dishwasher Safe Parts:

Brew basket, glass carafe and brew-through lid, water reservoir and lid, frother whisk, Ninja smart scoop, capsule bin, adjustable cup tray, cup tray base, and permanent filter (not included, sold separately) are dishwasher safe.

CLEANING THE FROTHER

Clean the frother whisk after each use. Hand-wash thoroughly or place on top rack of dishwasher.

CLEANING THE WATER RESERVOIR

NOTE: For best results, we recommend rinsing the reservoir after brewing and refilling with fresh water prior to the next brew.

Empty the reservoir and hand-wash or place in dishwasher. For a better clean, we recommend placing it in the bottom rack of the dishwasher standing upright with the opening facing downward. We recommend doing this weekly.

CLEANING THE CARAFE

We recommend cleaning your carafe after each use with warm, soapy water.

To clean the carafe more thoroughly, we recommend using a soft foam brush. **DO NOT** use a wire brush.

CLEANING THE CAPSULE BIN

Remove the cup tray, cup tray base, and capsule bin from under the capsule outlet. Discard the used capsules from the capsule bin. Hand-wash the cup tray, cup tray base, and capsule bin or place on top rack of dishwasher.

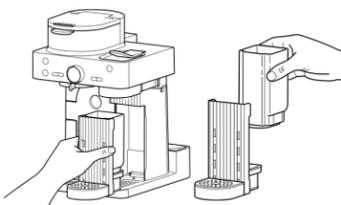

NOTE: Descaling solution not included

CLEANING THE BREW BASKET

If brewing grounds, allow the brewer to cool, then remove the brew basket by pinching the handle and lifting straight up. If using a paper filter, discard the filter by dumping the brew basket upside down into a waste-bin.

CLEANING & DESCALING YOUR BREWING SYSTEM

Your Ninja Espresso & Coffee Barista System offers two sides to choose from: Grounds and Capsules. Either side that you use will eventually need to be cleaned with a clean cycle. The clean cycle is used for descaling the brewer when calcium scale buildup is affecting the performance of the brewer and/or the flavor of your coffee.

When cleaning is needed in Grounds mode, the Intelligent Clean Cycle Indicator will automatically illuminate orange under the Grounds Button. If the indicator is ignored, your brewer may stop mid-brew and display "CLn," indicating it needs immediate cleaning.

Descaling Grounds Side:

- 1 Place the empty carafe beneath the brew basket.

- 2 Use a descaling solution specifically formulated for coffeemaker cleaning and follow the directions on the package. Fill the water reservoir up to, but not exceeding, the Full line.

OR

- Fill the water reservoir to the Travel Mug line (16 oz.) with white vinegar, then fill the rest of the reservoir with water up to, but not exceeding, the Full line.

IMPORTANT: Only use white vinegar.

NOTE: Running a water-only clean cycle will not descale the brewer properly.

- 3 Once the water reservoir is filled with the cleaning solution and water mixture, press the Grounds Button then press the CLEAN button.

- 4 Press START BREW to begin the cleaning cycle.

NOTE: To cancel the clean cycle, press the Power button or CLEAN button once. The brewer will beep and stop brewing through the cleaning mixture. Continue to follow the instructions starting at Step 6.

8 1 4 1 0 0 0 6 3



Printed in Mexico / Sc: 07-25-2023
Obpn:CFN600Series_IB_REV_Mv5_220715
Shnmdl: CFN601_B / TAB Elbrd: m. c