

# NINJA®

## SPECIALTY

### COFFEE MAKER

---

## OWNER'S GUIDE



# THANK YOU

for purchasing the Ninja® Specialty Coffee Maker.

## TECHNICAL SPECIFICATIONS

Voltage: 120V~ 60Hz.

### PLEASE READ CAREFULLY AND KEEP FOR FUTURE REFERENCE.

These instructions are designed to help you get a complete understanding of your new Ninja Specialty Coffee Maker.

## CONTENTS

<b>Parts</b> .....	<b>5</b>
<b>Preparing Your Ninja Specialty Coffee Maker for Use</b> .....	<b>8</b>
Setting the Clock .....	8
High-Altitude Calibration Brew .....	8
Priming Your Ninja Specialty Coffee Maker .....	9
<b>Brew Volumes &amp; Measurements</b> .....	<b>10</b>
How Much Do You Get in Your Cup? .....	10
Measuring Your Coffee Grounds .....	10
<b>Using the Brew Basket</b> .....	<b>11</b>
<b>Using the Drip Stop</b> .....	<b>12</b>
Can't Wait for the First Cup? .....	12
Closing the Drip Stop After a Brew .....	12
<b>Custom Brews</b> .....	<b>13</b>
Classic and Rich Brews .....	13
Over Ice Brew .....	13
<b>Specialty Brew and Frothing Milk</b> .....	<b>14</b>
Specialty Brew .....	14
Frothing Milk .....	14
<b>Intelligent Warming Plate &amp; Stay Warm Button</b> .....	<b>15</b>
Intelligent Warming Plate .....	15
Stay Warm Button .....	15
<b>Time &amp; Temperature Adjustment</b> .....	<b>16</b>
<b>Delay Brew</b> .....	<b>17</b>
<b>Care &amp; Maintenance</b> .....	<b>17</b>
After Each Brew .....	17
Cleaning the Water Reservoir .....	17
Cleaning the Carafe .....	17
<b>Cleaning &amp; Descaling</b> .....	<b>18</b>
<b>Troubleshooting</b> .....	<b>19</b>

# IMPORTANT SAFEGUARDS

READ ALL INSTRUCTIONS BEFORE USE • HOUSEHOLD USE ONLY

Read all instructions before using your NINJA® SPECIALTY COFFEE MAKER.

When using electrical appliances, basic safety precautions should always be followed, including the following:

## ⚠ WARNING

To reduce the risk of fire, electric shock, serious injury, death, or damage when using this appliance, follow these basic safety precautions.

### General Precautions

- 1 This appliance can be used by children aged from 8 years and above and persons with reduced physical, sensory or mental capabilities or lack of experience and knowledge if they have been given supervision or instruction concerning use of the appliance in a safe way and understand the hazards involved.
- 2 To reduce the risk of electric shock, this appliance has a polarized plug (one blade is wider than the other). As a safety feature, this plug will fit into a polarized outlet only one way. If the plug does not fit fully into the outlet, reverse the plug. If it still does not fit, contact a qualified electrician. **DO NOT** force into outlet or try to modify to fit.
- 3 Keep the appliance and its cord out of reach of children less than 8 years.
- 4 To eliminate a choking hazard for young children, remove and discard the protective cover fitted on the power plug of this appliance.
- 5 Children shall not play with the appliance.
- 6 To protect against fire, electric shock, and injury to persons, **DO NOT** immerse cord, plugs, or body of machine in water or other liquid.
- 7 **NEVER** carry the appliance by the power cord or pull it to disconnect from electrical socket; instead grasp the plug and pull to disconnect.

- 8 **DO NOT** operate any appliance with a damaged cord or plug, or after the appliance malfunctions, or has been dropped or damaged in any manner. Contact a Service center.
- 9 For household and work top use only. **DO NOT** let the power cord hang over the edge, or touch hot surfaces such as the stove.
- 10 **NEVER** use socket below counter.
- 11 To avoid risk of fire, electrical shock, or damage to the unit, **DO NOT** store or use unit in an appliance garage or under a wall cabinet.
- 12 Unplug from outlet when either the appliance or display clock is not in use, and before cleaning.
- 13 Turn off and allow to cool before putting on or taking off parts, and before cleaning the appliance.

### Operating Notice

- 14 The use of an accessory not recommended by the manufacturer may create an overflow condition and scalding hazard, or result in fire, electric shock, or personal injury.
- 15 **ALWAYS** use appliance on a clean, dry, level surface.
- 16 **DO NOT** place on or near a hot gas or electric burner or in a heated oven.
- 17 **DO NOT** use this appliance for anything other than its intended use.
- 18 **DO NOT** use outdoors.
- 19 **DO NOT** touch hot surfaces. Use handles or knobs.
- 20 To avoid contact with steam and hot surfaces, **DO NOT** reach across top of brewer to froth.

- 21 **ALWAYS** place a vessel beneath the brew basket to receive the brewed coffee.
- 22 Scalding may occur if brew basket is opened during a brew or clean cycle.
- 23 **DO NOT** remove the vessel while the appliance is running without the Drip Stop in the closed position. Return the vessel quickly and open the Drip Stop to continue the brew.
- 24 **DO NOT** fill water reservoir with anything other than water, as other liquids may damage your brewer.
- 25 **DO NOT** overfill the water reservoir. Fill water only to the Max Fill line.
- 26 **DO NOT** run the appliance without water.
- 27 Exceeding maximum brew basket capacity may cause overflow. **DO NOT** use fine or espresso ground coffee.

### Carafe





- 28 The carafe is designed for use with this appliance only. **DO NOT** place carafe on or near a hot gas or electrical burner, or in a heated oven.
- 29 **DO NOT** set a hot carafe on a wet or cold surface.
- 30 **DO NOT** use a cracked or scratched carafe or a carafe that has a loose or weakened handle.
- 31 **DO NOT** clean carafe with abrasive cleaners, steel wool pads, or other abrasive materials.
- 32 **DO NOT** place carafe in microwave.
- 33 **DO NOT** expose carafe to extreme temperature changes.
- 34 **DO NOT** drink directly from the carafe. Liquid from the carafe may be very hot.

- 35 **DO NOT** use the carafe to store food when not in use.
- 36 Ensure the carafe is completely empty before starting a cleaning or brewing cycle. Starting a cycle with water, coffee, or tea in the carafe will cause an overflow.
- 37 Do not place thermal carafe in dishwasher.

### Care & Maintenance

- 38 Allow the appliance to cool before removing any parts and before cleaning.
  - 39 To prevent illness from bacterial growth in the appliance, follow all cleaning instructions in the Care & Maintenance section of this Owner's Guide.
  - 40 Clean the system on a weekly basis.
  - 41 If the product is not operating properly, visit ninjakitchen.com or contact SharkNinja Operating LLC for examination, repair, or adjustment. Any servicing needs shall be performed by an authorized service provider.
  - 42 Cleaning and user maintenance shall not be made by children unless they are older than 8 and supervised.
- Cord Statement**
- 43 A short power-supply cord is provided to reduce the risks resulting from becoming entangled in or tripping over a longer cord.
  - 44 **DO NOT** use extension cords with this product.

**⚠ WARNING ⚠**  
Risk of fire or electric shock  
Do not remove bottom cover.

	Indicates to read and review instructions to understand operation and use of product.
	Indicates the presence of a hazard that can cause personal injury, death or substantial property damage if the warning included with this symbol is ignored.
	Take care to avoid contact with hot surface. Always use hand protection to avoid burns.
	For indoor and household use only.

## READ AND SAVE THESE INSTRUCTIONS

# PARTS

- A** Coffee Maker  
(power cord & storage not shown)
- B** Showerhead
- C** Integrated Frother
- D** Frother Whisk
- E** Swinging Brew Basket
- F** Control Panel
- G** Single-Serve Cup Platform
- H** Ninja Smart Scoop™
- I** Flip-Top Water Reservoir Lid
- J** Removable Water Reservoir
- K** Removable Filter Holder
- L** Permanent Filter  
(not included on all models,  
sold separately)
- M** Ninja Carafe
- N** Brew-Through Lid
- O** Intelligent Warming Plate  
(not available on all models)
- P** Drip stop

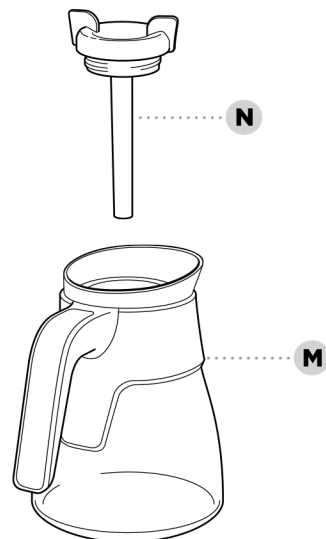

**NOTE:** Accessories may vary depending on the model.

**NOTE:** In order to ensure the highest possible standard for refurbished items, all units are thoroughly inspected as part of the process. For this item, water may be used during the refurbishing process and so; you may notice some condensation in the water reservoir. It is recommended to rinse the water reservoir with fresh water prior to its first use.

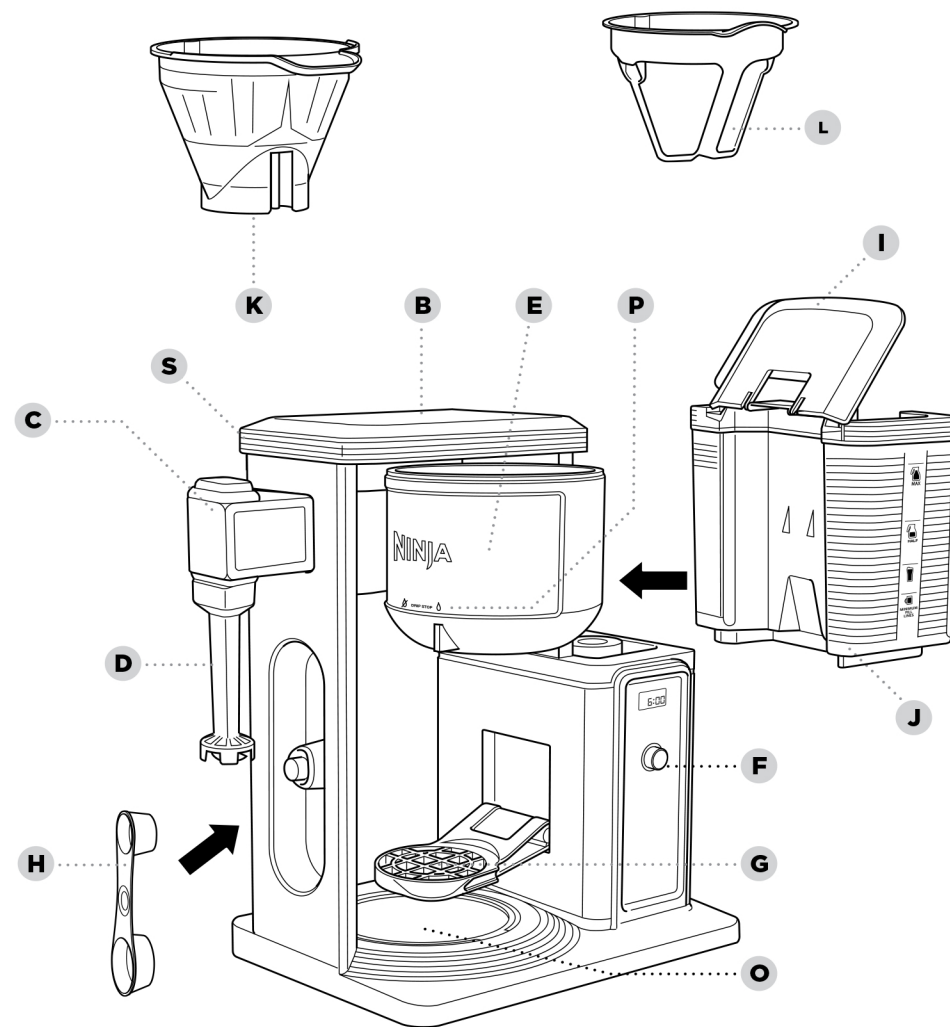

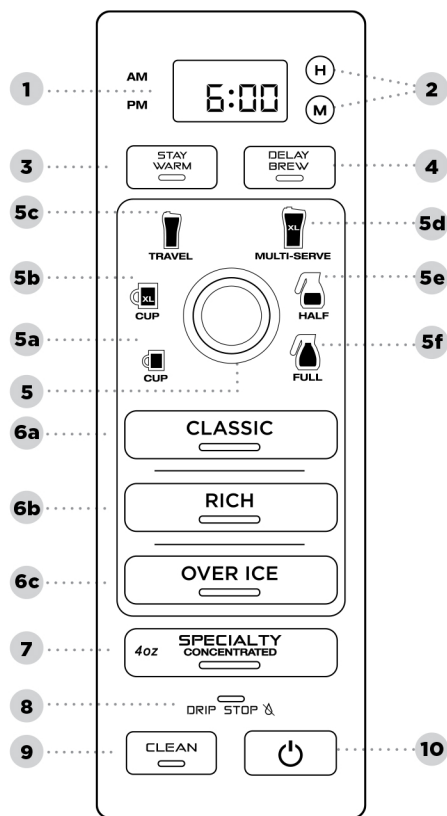

- 1 Programmable Digital Clock
- 2 Hour & Minute Buttons
- 3 Stay Warm Indicator/Button (not available on all models)
- 4 Delay Brew Button
- 5 Multi-Serve Dial
  - a Cup
  - b XL Cup
  - c Travel Mug
  - d XL Multi-Serve
  - e Half Carafe
  - f Full Carafe
- 6 Custom Brews
  - a Classic Brew
  - b Rich Brew
  - c Over Ice Brew
- 7 Signature Brew  
Specialty Brew
- 8 Drip Stop Indicator
- 9 Intelligent Clean Cycle Indicator/Button
- 10 Power Button

Remove all packaging material and stickers from the coffee maker. Wash the water reservoir, carafe, removable filter holder, and permanent filter (not included on all models) in warm, soapy water with a soft cloth. Rinse parts and dry thoroughly. Before first use, prime the system by running a Full Carafe, Classic brew cycle with water only. After the cycle is complete, discard the water. For detailed instructions, refer to the Priming Your Ninja Specialty Coffee Maker section.

**PLEASE KEEP THIS IMPORTANT SAFEGUARD IN MIND WHEN USING THE APPLIANCE:**  
DO NOT run the appliance without water.

## SETTING THE CLOCK

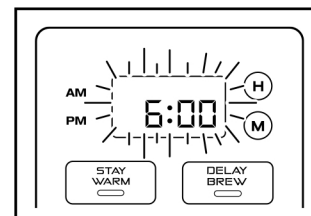

- 1 When the unit is plugged in, the clock will flash on the control panel to indicate that the time has not been set.
- 2 Press the hour (H) or minute (M) button until you reach the current time. The AM or PM indicator will illuminate on the left side of the display as you are setting the time.
- 3 After 5 seconds, the clock will stop flashing and the clock will be set.

**NOTE:** If the clock stops flashing and does not display the correct time of day, pressing the hour (H) or minute (M) button at any time will cause the clock to flash again. You can now reprogram the correct time by following the previous steps.

**NOTE:** If you unplug the coffee maker or in the event of a power loss, you will need to reset the clock the next time the coffee maker is plugged in.

## HIGH-ALTITUDE CALIBRATION BREW

Required for users in high-altitude areas. Not running the high-altitude calibration brew in a high-altitude area will result in excessive steaming during brewing.

Because water boils at lower temperatures at higher altitudes, running a calibration cycle before your first brew allows the unit to detect the boiling point of water at your location. Running a calibration cycle will help deliver a consistent brew each time.

- 1 Fill the water reservoir up to, but not exceeding, the Max Fill line.
- 2 Place the empty filter holder into the brew basket, and an empty vessel in the machine.
- 3 Press and hold both **CLASSIC** and **OVER ICE** until clock displays **CAL**.
- 4 A calibration cycle will begin. When complete, the unit will beep and **End** will appear on the clock display. Discard the water in the vessel.

**NOTE:** Pressing the CLASSIC, OVER ICE, or Power button will cancel the calibration cycle.

**NOTE:** This calibration is permanently saved and will not be lost if power is lost or brewer is unplugged. Brewer can be re-calibrated at any time if the altitude where it is being used changes.

# PRIMING YOUR NINJA SPECIALTY COFFEE MAKER

Clean all accessories before your first brew. Plug in unit and power it on.

**NOTE:** We recommend fresh, cool, filtered water. Well water is not recommended.

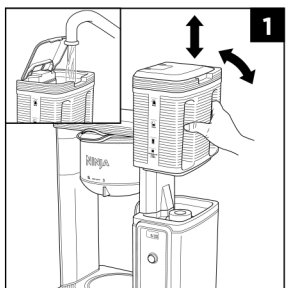

Lift the **Water Reservoir** to the right and up off the coffee maker. Flip the **Reservoir Lid** open or remove the entire lid. Add water up to, but not exceeding, the **Max Fill** line. Return the water reservoir to the coffee maker.

DO NOT fill water reservoir with anything other than water, as other liquids may damage your coffee maker.

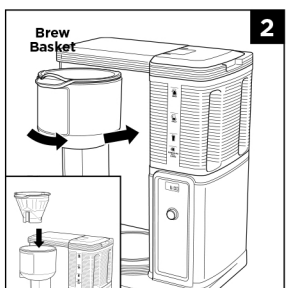

Insert the **Filter Holder** into the **Swinging Brew Basket**. Close the brew basket until you hear a slight click.

**NOTE:** DO NOT place any ground coffee in the brew basket during the priming brew.

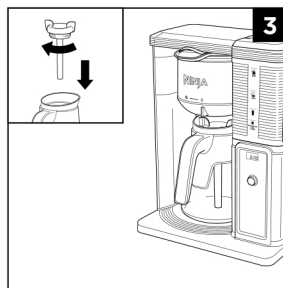

Twist the **Brew-Through Lid** clockwise onto the **Carafe** to lock into place and center the carafe below the brew basket.

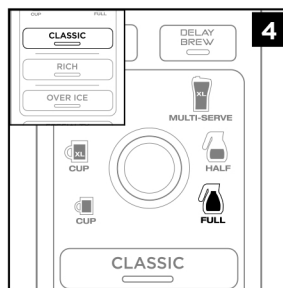

With everything securely in place and the unit powered on, select the **Full Carafe** size and press **CLASSIC**.

When the cycle is complete, discard the water in the carafe.

You are now ready to use your Ninja Specialty Coffee Maker.

# BREW VOLUMES & MEASUREMENTS

## HOW MUCH DO YOU GET IN YOUR CUP?

Each size and brew style produces a different amount of coffee to optimize strength and taste.

## APPROXIMATE BREW VOLUMES

Size	Classic	Rich	Over Ice	
			coffee	filled with ice
Cup	9.5 oz.	8.7 oz.	3.8 oz.	9.5 oz.
XL Cup	11.5 oz.	10.3 oz.	4.7 oz.	11.5 oz.
Travel Mug	14 oz.	13.2 oz.	5.8 oz.	14 oz.
XL Multi-Serve	18 oz.	16 oz.	7.3 oz.	18 oz.

**You don't need to adjust the size for Specialty Brew—it always yields approximately 4 oz.**

**NOTE:** The coffee grounds will absorb some of the water that is brewed, resulting in slightly less brewed coffee than water used.

**NOTE:** There may be some water left in the reservoir after your brew. This is normal to keep the brewer from running out of water.

**NOTE:** Brew volumes may be slightly larger or smaller than what is stated due to various factors in the system.

## MEASURING YOUR COFFEE GROUND

For best results, use the measurements on the Ninja Smart Scoop™ or in the chart to the right to determine how much ground coffee to use for each brew size. The amount of ground coffee for each size will remain the same for any brew type you select. For example, if you select **Cup** and **CLASSIC**, you will use the same amount of coffee grounds as if you select **Cup** and **OVER ICE**.

Serving Size	Ninja Smart Scoop™	Tablespoons
Cup/XL Cup	2-3 small scoops	2-3 Tbsp.
Travel Mug/XL Multi-Serve	3-5 small scoops	3-5 Tbsp.
Half Carafe	3-4 big scoops	6-8 Tbsp.
Full Carafe	4-6 big scoops	8-12 Tbsp.
Specialty (4 oz.)	2 big scoops	4 Tbsp.

**NOTE:** Measurements are based on level scoops—adjust to your preferred taste. More scoops result in stronger coffee but slightly lower volumes, fewer scoops result in weaker coffee and slightly higher volumes. Use a medium-sized grind if grinding whole beans. Grinding beans too finely may cause the brew basket to overflow.

**NOTE:** Decaffeinated coffee absorbs water differently than regular coffee grounds, use fewer scoops to prevent overflow.

## USING THE BREW BASKET

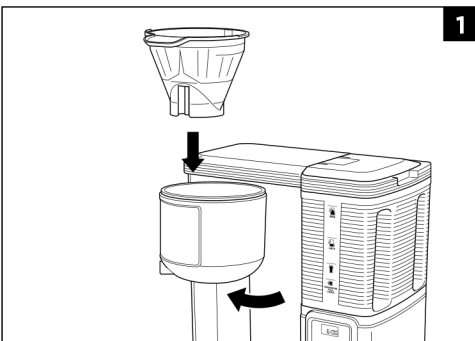

1

Open the brew basket by swinging it out of the coffee maker.  
Insert the **Filter Holder** in the brew basket.

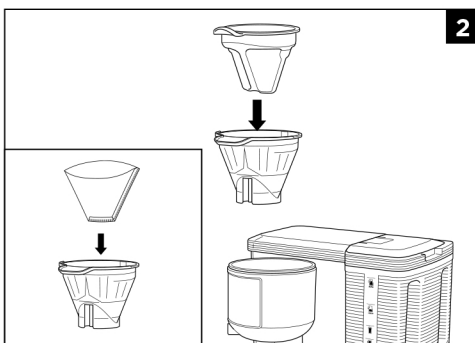

2

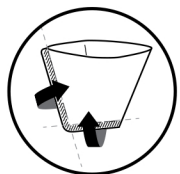

(Not supplied)

**NOTE:** If using a paper filter, first ensure the permanent filter is removed from the filter holder. Then fold the paper filter along the seams, open it fully, and firmly press it into the filter holder, making sure it is fully seated.

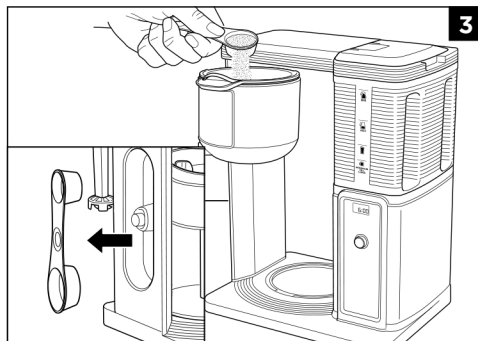

3

Use the **Ninja Smart Scoop™** and follow the measurements on the scoop to fill the filter.

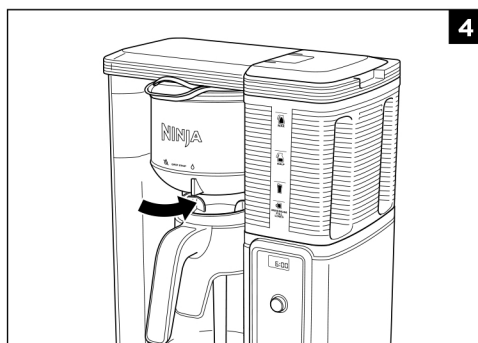

4

Slide the brew basket back into the coffee maker until it clicks into place.

## USING THE DRIP STOP

The drip stop is used to close off the brew basket to prevent any coffee from dispensing. You will need to manually open and close the drip stop by moving the lever to your desired position. It can be closed and reopened at any point before, during, or after a brew.

### CAN'T WAIT FOR THE FIRST CUP?

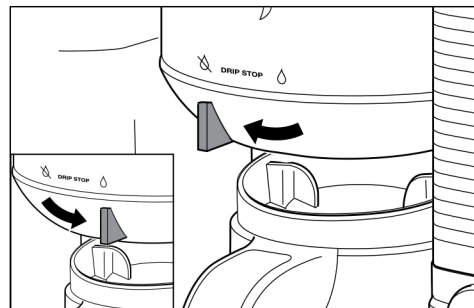

When brewing a carafe, close the **Drip Stop** to pause the brew cycle and pour a cup. Promptly replace the carafe and open the Drip Stop to complete the brew.

If you forget to open the Drip Stop, the coffee maker will pause the brew, and after 20 seconds it will give you a friendly audible reminder. After 6 minutes, the brew will be canceled.

**NOTE:** If the Drip Stop is closed before you begin a brew, the coffee maker will notify you with 5 beeps and the Drip Stop indicator will illuminate. Set the Drip Stop to the open position and select your brew type.

### CLOSING THE DRIP STOP AFTER A BREW

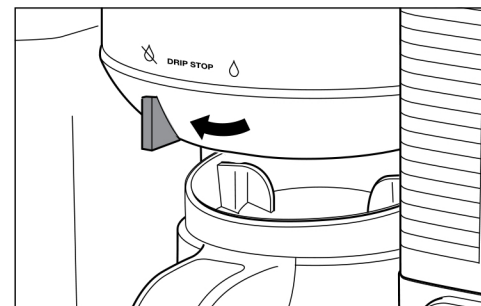

When the brew cycle is complete, set the Drip Stop to the closed position to stop dripping from the brew basket. While the Drip Stop is closed, the Drip Stop indicator will illuminate.

**NOTE:** Remember to open the Drip Stop when you are ready to brew again. If you forget, your coffee maker will give you a friendly audible reminder.

# CUSTOM BREWS

**NOTE:** For single cup, lower the Single-Serve Cup Platform and set your vessel in the center of it. Ensure you are using at least a 12 oz. cup for the Cup size, 14 oz. cup for the XL Cup size, 16 oz. travel mug for the Travel Mug size, and 20 oz. travel mug for the XL Multi-Serve size.

## CLASSIC AND RICH BREWS

**NOTE:** Rich brew will yield slightly less brewed coffee than Classic brew. See approximate brew volume chart for more information.

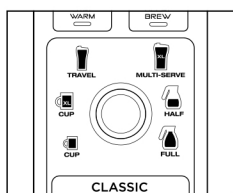

Use the **Multi-Serve Dial** to select the brew size. Place the empty vessel you would like to brew into under the brew basket.

### CLASSIC

### RICH

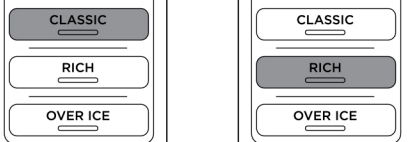

Press **CLASSIC** or **RICH** and the brew will begin. Press **CLASSIC** or **RICH** again to cancel the brew and the clock will display “StOP”.

The brew will begin, stop, and be quiet for a short period of time before it begins again. This process is used to evenly saturate the coffee grounds.

The unit will beep to signal a completed brew.

**NOTE:** The unit will not beep when the brew starts. If “StOP” displays on the clock, the brew has been canceled. Press **CLASSIC** or **RICH** to begin the brew again.

## OVER ICE BREW

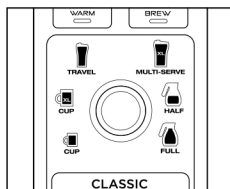

Use the **Multi-Serve Dial** to select the brew size. Fill your desired vessel to the top with ice cubes and place the vessel below the brew basket.

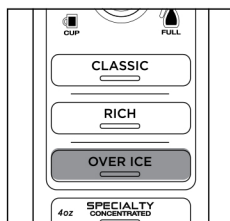

Press **OVER ICE** and the brew will begin. Press **OVER ICE** again to cancel the brew and the clock will display “StOP”.

The brew will begin, stop, and be quiet for a short period of time before it begins again. This process is used to evenly saturate the coffee grounds.

The unit will beep to signal a completed brew.

**NOTE:** DO NOT use glassware. However, the Ninja glass carafe is safe to use due to its specialized glass material.

**IMPORTANT:** Always fill the desired vessel to the top with ice before placing it below the brew basket. DO NOT add ice to the water reservoir.

**NOTE:** It is normal for some ice in the vessel to melt as the coffee is brewed, and this will produce a cold beverage with the ideal strength and flavor.

**NOTE:** The unit will not beep when the brew starts. If “StOP” displays on the screen, the brew has been canceled. Press **OVER ICE** to begin the brew again.

# SPECIALTY BREW & FROTHING MILK

## SPECIALTY BREW

**NOTE:** You don't need to adjust the size for Specialty Brew—it always yields approximately 4 oz.

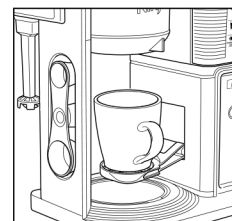

Place the empty vessel you would like to brew into under the brew basket.

**NOTE:** If brewing an iced blended drink, fill the desired vessel with the amount of ice recommended in the recipe before brewing.

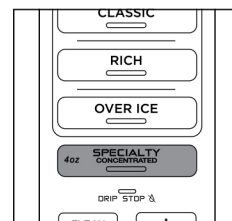

Press **SPECIALTY** and the brew will begin. Press **SPECIALTY** again to cancel the brew and the clock will display “StOP”.

The brew will begin, stop, and be quiet for a short period of time before it begins again. This process is used to evenly saturate the coffee grounds.

The unit will beep to signal a completed brew.

**NOTE:** The unit will not beep when the brew starts. If “StOP” displays on the screen, the brew has been canceled. Press **SPECIALTY** to begin the brew again.

## FROTHING MILK

**The integrated frother does not heat liquid.**

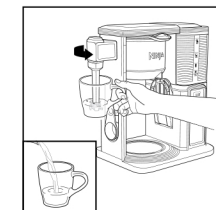

Pour milk into cup, until it is about  $\frac{1}{3}$  full. (Use more or less milk depending on your preference.) For hot froth, microwave 45 to 60 seconds.

Move the frother into the ready position by swinging the arm toward the front.

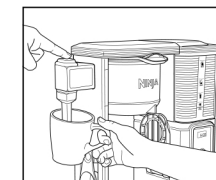

For best results, hold the cup under the frother and submerge the whisk just below the surface of the milk.

Press and hold the frothing button for 30 to 45 seconds.

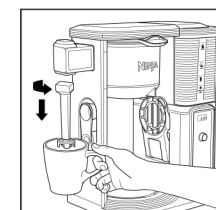

You can remove the frother whisk by twisting it clockwise. To avoid spills, keep your cup below the whisk and carry it to your sink or dishwasher for cleaning.

**WARNING:** To avoid contact with steam and hot surfaces, DO NOT reach across top of brewer to froth.



# INTELLIGENT WARMING PLATE & STAY WARM BUTTON

## INTELLIGENT WARMING PLATE

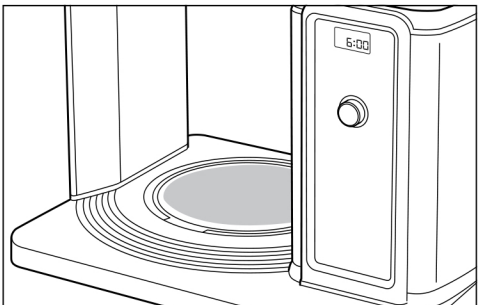

The **Intelligent Warming Plate** will automatically turn on during a Half or Full Carafe size of Classic or Rich brew. The Intelligent Warming Plate is set to a specific temperature setpoint to avoid burning the coffee over time.

**IMPORTANT:** The **HOT SURFACE**  indicator will illuminate when the warming plate is hot.

**NOTE:** Thermal carafe (CM407) does not include a warming plate because of the thermal carafe's vacuum insulation.

## STAY WARM BUTTON

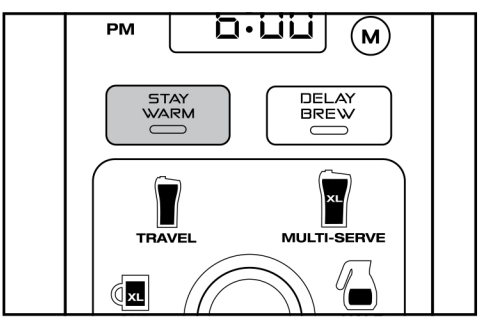

Press **STAY WARM** after the brew to turn the Intelligent Warming Plate off. To turn the Intelligent Warming Plate on at any time turn the dial to one of the carafe sizes and press **STAY WARM**.

**IMPORTANT:** The **HOT SURFACE**  indicator will remain illuminated until the warming plate has cooled to a safe temperature.

# TIME & TEMPERATURE ADJUSTMENT

You can adjust how long the **Intelligent Warming Plate** remains on (up to 4 hours) and/or set the temperature to High or Low. By default, the Intelligent Warming Plate is set to remain on for 2 hours, and is set to High to keep your coffee hot. The Low setting keeps your brew at a slightly lower temperature to preserve flavor longer.

To change the time/temperature settings of your warming plate, follow these instructions:

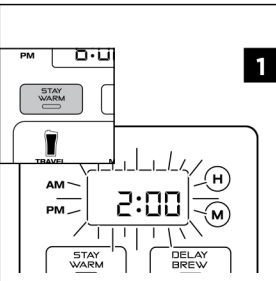

Press and hold **STAY WARM** until the clock begins to flash the current warming time.

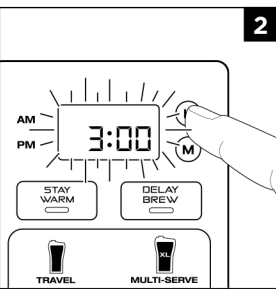

Quickly press the hour (H) and/or minute (M) buttons to increase the time up to 4 hours or decrease the time to 0 hours. Press **STAY WARM** to set the new time. The brewer will automatically save the new time after 5 seconds of inactivity.

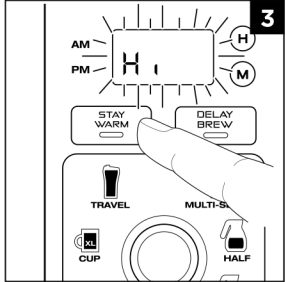

Next, the clock will display the current warming plate temperature. To keep the same temperature, press **STAY WARM**, or wait 5 seconds for the same temperature to lock in. To change the temperature, press the hour (H) or (M) buttons, then press **STAY WARM**. The brewer will automatically save the new time after 5 seconds of inactivity.

**NOTE:** If you set the warming time to 0 hours, it will skip the warming temperature menu.

**NOTE:** If the warming time is set to 0 hours, the Intelligent Warming Plate will not automatically activate during a carafe brew cycle.

# DELAY BREW, CARE & MAINTENANCE

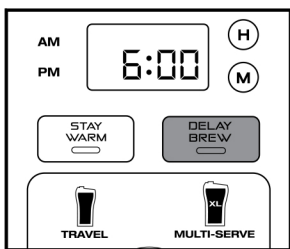

**NOTE:** The unit must remain on for the Delay Brew function to work. **DO NOT** power off or unplug after setting Delay Brew.

**IMPORTANT:** Make sure the Drip Stop is in the open position.

- 1 Plug the unit in and turn it on by pressing the power button
- 2 After filling the water reservoir and adding ground coffee to the filter holder, be sure the reservoir and brew basket are securely in place. Place the appropriately sized vessel under brew basket.
- 3 Press **DELAY BREW**. **DELAY BREW** will illuminate and the clock will begin to flash "12:00" or the last Delay Brew time that was set.
- 4 Use the H and M buttons to set the time the brew will begin. Then use the multi-serve dial to select the size of the vessel you would like to brew into.
- 5 Select the brew style that you desire from the 4 flashing buttons. The selected brew style will remain illuminated.
- 6 Once the time, brew size, and brew style have been set, allow **DELAY BREW** to stop flashing, or press **DELAY BREW** to activate. When activated, the unit will beep and **DELAY BREW** and your selected options will remain illuminated. To cancel, press **DELAY BREW** again.

**NOTE:** If you attempt to change your selections while Delay Brew is set, the unit will beep and **DELAY BREW** will flash. To change your selections, cancel Delay Brew and repeat the process again.

## AFTER EACH BREW

**NOTE:** For best results, we recommend rinsing the reservoir after brewing and refilling with fresh water for the next brew.

- 1 After the unit has cooled, remove the filter holder from the brew basket. If using a paper filter (not supplied), discard it. If using the permanent filter, wash it thoroughly with soap and warm water or place on top rack of dishwasher.
- 2 Clean the frother whisk after each use. Hand-wash thoroughly with soap and warm water or place on top rack of dishwasher.
- 3 Wash the carafe and brew-through lid with soap and warm water. Use a bottle brush or a cloth to wash the inside of the carafe. **DO NOT** use a wire brush.

**NOTE:** The glass carafe, brew-through lid, permanent filter, removable filter holder, water reservoir, flip-top lid, frother whisk, and scoop are dishwasher safe.

- 4 After the coffee maker has cooled, wipe down the main unit, showerhead, and water reservoir shelf with a cloth and warm water. **DO NOT** immerse the coffee maker in water.

## CLEANING THE WATER RESERVOIR

Empty the reservoir and hand-wash or place in dishwasher. For a better clean, we recommend placing it on the bottom rack of the dishwasher standing upright with the opening facing downward. We recommend doing this weekly.

## CLEANING THE CARAFE

We recommend cleaning your carafe with warm, soapy water.

If you want to clean the carafe more thoroughly, we recommend using a soft foam brush or placing it in the dishwasher (glass carafe only). **DO NOT** use a wire brush.

# CLEANING & DESCALING

The **CLEAN** button will illuminate when a cleaning cycle is recommended for your unit, as calcium scale buildup could be affecting the flavor of your coffee.

To clean and descale your Ninja® Specialty Coffee Maker:

**NOTE:** The clean cycle takes approximately 60 minutes. If you cancel the clean cycle, your machine will not be properly descaled.

- 1 Select the **Full Carafe** size and set the empty carafe beneath the brew basket.
- 2 Use a descaling solution specifically formulated for coffee maker cleaning and follow the directions on the package. Fill the water reservoir up to, but not exceeding, the Max Fill line (50 oz.).

**OR**

Fill the water reservoir to the Travel Mug line (16 oz.) with white vinegar, then fill the rest of the reservoir with water up to, but not exceeding, the Max Fill line.

**IMPORTANT:** Use only white vinegar

- 3 Once the water reservoir is filled, press the **CLEAN** button.

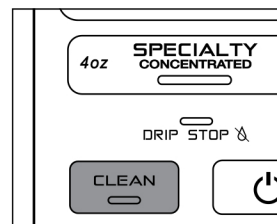

**NOTE:** To cancel the clean cycle, press the Power button or CLEAN button once. The unit will beep and stop brewing through the cleaning mixture. Continue to follow the instructions starting at Step 6.

**NOTE:** Running a water-only clean cycle will not descale the brewer properly.

- 4 The clock will display and count down the remaining clean cycle time, which takes approximately 60 minutes to complete. Your unit will deliver a small amount of cleaning solution to distribute it through the system. It will then pause, deliver additional cleaning solution, and continue for 60 minutes. The extended pauses allow for maximum cleaning and descaling.

**IMPORTANT:** DO NOT remove the carafe at any time throughout the clean cycle.

- 5 Upon completion, the coffee maker will beep, the clock will display **End**, and the **CLEAN** light will turn off.
- 6 Empty the contents of the carafe and place it back under the brew basket. Clean the water reservoir with warm, soapy water to remove any cleaning solution that could affect the flavor of your coffee.
- 7 Fill the reservoir with fresh water up to, but not exceeding, the Max Fill line.
- 8 Flush the system by running a **Full Carafe, Classic brew** cycle with water only. After the cycle is complete, discard the water and thoroughly clean the carafe.

**NOTE:** Hard water will cause scale buildup faster than soft water and the brewer will indicate it needs cleaning more often.

**NOTE:** If the clock ever reads "CLn" it indicates heavy scale build-up on the boiler. Run a clean cycle before attempting to brew again.

# TROUBLESHOOTING GUIDE

## There's sediment in my coffee.

- If using a permanent filter, the sediment at the bottom of the brewed coffee may be due to using finely ground coffee.
- To reduce the amount of sediment in the brewed coffee, use a slightly coarser grind or use a paper filter.

**NOTE:** We **DO NOT** recommend using a paper filter in conjunction with the permanent filter, as clogging and backing up of water and/or coffee in the filter basket can occur.

## Coffee is too weak.

- For stronger coffee, use the Rich brew setting. For an even bolder flavor, you can add more coffee grounds to the filter.

## Coffee is too strong.

- For milder coffee, use the Classic brew setting. For an even milder flavor, use fewer coffee grounds in the filter.

## Brew cycle is too slow.

- Depending on your settings, your brew time will vary from around 4 minutes to 10 minutes. Full carafe sizes and Rich brews will take longer to brew than single-serve and Classic brews.

## Cup or travel mug overflowed.

- Ensure you are using at least a 12 oz. cup for the Cup size, 14 oz. cup for the XL Cup size, 16 oz. travel mug for the Travel Mug size, and 20 oz. travel mug for the XL Multi-Serve size.

## Brew basket overflowed.

- The bottom of the filter holder may be clogged. This can happen with finely ground coffee or too many coffee grinds in the brew basket. Medium-ground coffee is recommended. Refer to the Measuring Your Coffee Grounds chart on page 10.
- Using both the permanent filter and a paper filter can cause grounds to clog and water to back up in the brew basket. Use only the permanent filter or paper filter.
- Decaf coffee grounds absorb water differently, use fewer scoops when using decaf grounds.

## There's water left in the reservoir.

- The water reservoir markings are minimum fill lines that indicate the amount of water needed for that brew size. However, all brew styles use different amounts of water to create the proper flavor and concentration. It is normal for water to be left in the reservoir after a brew to prevent the brewer from running out of water.

## Coffee maker is leaking.

- After removing the water reservoir, there may be a small amount of water in the reservoir valve. This can be easily removed with a dry cloth.
- If the leak is coming from the bottom of the brew basket, make sure all parts are assembled correctly and securely, and the drip stop is closed.
- If the leak is coming from the bottom of the coffee maker, contact a Service center.

## CLEAN light is on.

- Run a clean cycle. If you have recently completed a clean cycle, you may need to run a second cycle to remove additional mineral buildup that occurs naturally over time.

## CLOCK DISPLAY MESSAGES:

- **"Add Wtr"** The system does not have enough water in the reservoir to complete your brew. Add fresh water to the reservoir, then press your selected brew style to resume the brew.
- **"CLn"** The system has detected that a clean cycle needs be run immediately to remove calcium scale buildup in the boiler. See 'Cleaning & Descaling' for instructions.
- **"StOP"** A brew cycle was canceled.

## ERROR MESSAGES

- **"Er"** If the clock displays "Er" and then a number (ex. "Er 03"), contact a Service center.



PRINTED IN MEXICO  
OBPN: CM400\_IB\_MP\_Mv6\_190228  
SC: 01-06-2020\_TAB

Elbrd: Y.T.  
MODEL: CM401\_E2GB

