

Shark[®] Rocket[™] ULTRA-LIGHT UPRIGHT

QUICK START GUIDE

WHAT'S INSIDE

- A** Handheld Vacuum
- B** Motorized Floor Nozzle
- C** Wand
- D** Crevice Tool
- E** Pet Multi-Tool
- F** Hard Floor Hero[™]

ASSEMBLY

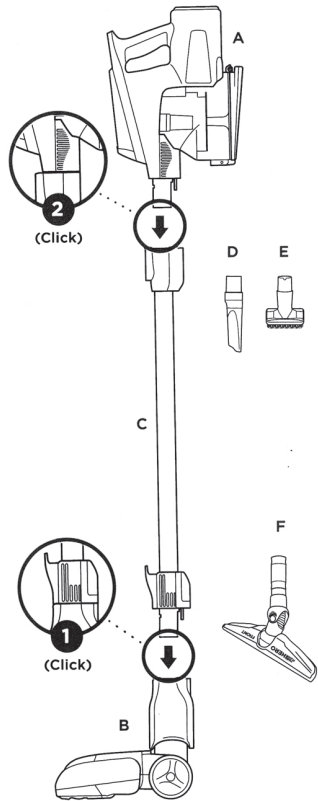

STORAGE

Onboard Hook

For compact, convenient storage, hang the handheld vacuum on the hook on the bottom of the wand, and wrap the power cord around the cord hooks. The unit stores easily in a closet or along a wall.

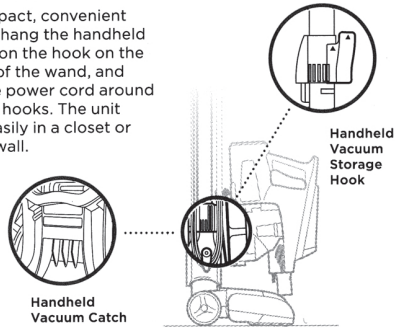

MAINTENANCE

Empty the dust cup every time debris reaches the MAX fill line.

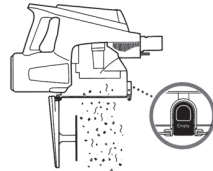

Brushroll Maintenance

A portion of the base is removable to allow for better access to the brushroll and exposure to the airway. Remove any string, carpet fibers, or hair that may be wrapped around the brushroll. Loosen debris by cutting across the groove on the brushroll with a pair of scissors.

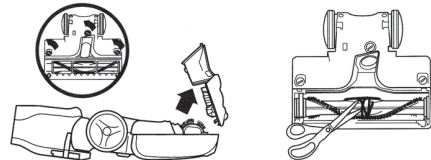

VERSATILE FLOOR-TO-CEILING CLEANING

FLOOR CLEANING

- 1 Plug In Vacuum**
Then place your foot gently on the floor nozzle and tilt the handle back.

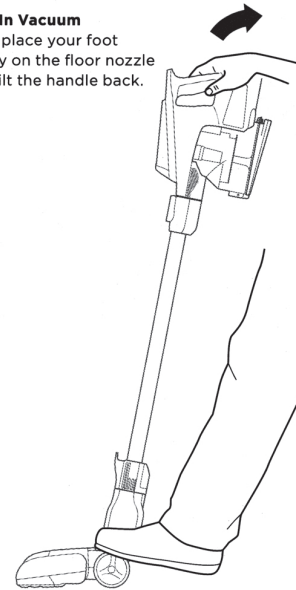

ABOVE-FLOOR CLEANING

- 1** While holding the vacuum upright, push the Nozzle Release button and pull the wand up to disconnect it from the floor nozzle.

OR

Press the Wand Release button on the top of the wand to disconnect it from the handheld vacuum.

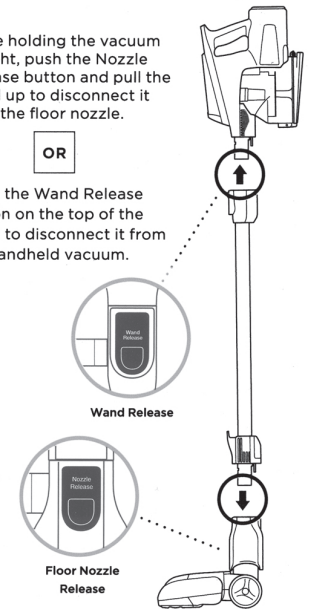

- 2 Choose Setting**
The Rocket[®] Ultra-Light Upright has a 2-speed power slider switch on the handle. Slide the power switch to the appropriate floor setting and start cleaning.

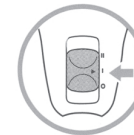

Setting I
Gentle on bare floors and delicate area rugs.
The brushroll spins slowly to clean bare floors and delicate area rugs.

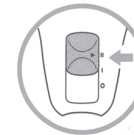

Setting II
Deep cleans carpets by removing embedded dirt.
The brushroll spins faster to pick up debris below the surface of your carpets.

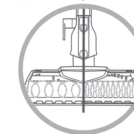

NOTE:
For deep cleaning per ASTM F 608 (embedded dirt in carpet) please use Setting II, high pile carpet mode.

- 2** Attach desired cleaning accessory.

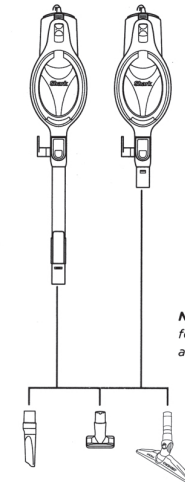

NOTE: Use Setting I for all above-floor accessories.

804009024C



Printed in Mexico

Sc: 08.14.2018

Pgs: 1

Obpn: HV301_QSG_170303

10.07.2020

Shnmdl: HV301_E3GB_Elbrd:i.a.

804009024C

Shark Rocket™

INSTRUCTIONS

804109025

IMPORTANT SAFETY INSTRUCTIONS

FOR HOUSEHOLD USE ONLY

WARNING

To reduce the risk of injury, fire, electric shock, and property damage resulting from improper use of the appliance, carefully observe the following instructions. This unit contains electrical connections and moving parts that potentially present risk to the user.

THE MOTORIZED FLOOR NOZZLE, WAND, AND HANDHELD VACUUM CONTAIN ELECTRICAL CONNECTIONS:

- These are not serviceable parts.
 - Do not use to vacuum any liquids.
 - Do not immerse in water when cleaning.
 - If handheld vacuum/wand is damaged, discontinue use.
- 1 Inspect power cord and plug for any damage before use. DO NOT use vacuum cleaner with a damaged cord or plug. Turn off all controls before plugging or unplugging the vacuum cleaner. Store your vacuum cleaner with the power cord secured around the two cord hooks.
 - 2 DO NOT use outdoors or on wet surfaces. Use only on dry surfaces.
 - 3 Unplug from electrical outlet when not in use and before servicing.
 - 4 If vacuum cleaner is not working as it should, has been dropped, damaged, left outdoors, or dropped into water, call a service center.
 - 5 DO NOT pull or carry vacuum cleaner by the cord or use the cord as a handle.
 - 6 DO NOT unplug by pulling on cord. Grasp the plug, not the cord.
 - 7 DO NOT handle plug or vacuum cleaner with wet hands.
 - 8 DO NOT run the vacuum cleaner over the power cord, close a door on the cord, or pull cord around sharp corners.
 - 9 The use of an extension cord is NOT recommended.
 - 10 DO NOT leave vacuum cleaner when plugged in.
 - 11 Keep cord away from heated surfaces.
 - 12 Always turn off the vacuum cleaner before connecting or disconnecting motorized nozzle.
- #### GENERAL USE
- 13 Use only as described in this manual.
 - 14 Keep your work area well lit.
 - 15 Keep the vacuum cleaner moving over the carpet surface at all times to avoid damaging the carpet fibers.
 - 16 DO NOT place vacuum cleaner on unstable surfaces such as chairs or tables.
 - 17 DO NOT put any objects into openings. DO NOT use with any opening blocked; keep free of dust, lint, hair, and anything that may reduce airflow.
 - 18 DO NOT allow the appliance to be used by children. Close supervision is necessary when used near children. This is not a toy.
 - 19 DO NOT use without filters in place.
 - 20 DO NOT use if airflow is restricted; if the air paths or the motorized floor nozzle become blocked, turn the vacuum cleaner off and unplug from electrical outlet. Remove all obstructions before you turn on the unit again.

- 21 Keep nozzle away from hair, face, fingers, uncovered feet, or loose clothing.
- 22 Only use manufacturer's recommended attachments.

DUST CUP/FILTERS/ACCESSORIES

Before turning on the vacuum:

- 23 Make sure that all filters are thoroughly dry after routine cleaning.
- 24 Make sure that dust cup and all filters are in place after routine maintenance.
- 25 Make sure accessories are free of blockages and keep openings away from face and body.
- 26 Only use Shark-brand filters and accessories (failure to do so will void the warranty).

GENERAL CLEANING

- 27 DO NOT pick up large objects.
- 28 DO NOT pick up hard or sharp objects such as glass, nails, screws, or coins that could damage the vacuum cleaner.
- 29 DO NOT use to pick up drywall dust, fireplace ash, or embers. DO NOT use as an attachment to power tools for dust collection.
- 30 DO NOT pick up smoking or burning objects such as hot coals, cigarette butts, or matches.
- 31 DO NOT pick up flammable or combustible materials (e.g., lighter fluid, gasoline, or kerosene) or use vacuum in areas where they may be present.
- 32 DO NOT pick up toxic solutions (e.g., chlorine bleach, ammonia, or drain cleaner).
- 33 DO NOT use in an enclosed space where vapors are present from paint, paint thinner, moth-proofing substances, flammable dust, or other explosive or toxic materials.
- 34 DO NOT vacuum up any liquids.
- 35 DO NOT immerse vacuum cleaner in water or other liquids.
- 36 Use extra care when cleaning on stairs.

POLARIZED PLUG

To reduce the risk of electric shock, this vacuum cleaner has a polarized plug (one blade is wider than the other). As a safety feature, this plug will fit into a polarized outlet only one way. If the plug does not fit fully into the outlet, reverse the plug. If it still does not fit, contact a qualified electrician. DO NOT force into outlet or try to modify to fit.

TECHNICAL SPECIFICATIONS

Voltage: 120V, 60Hz

ASSEMBLING YOUR VACUUM

WARNING: This vacuum does not stand up on its own, so when taking a break from cleaning, rest it against a piece of furniture or a wall, or lay it flat on the floor. Using for an application where the unit lacks stability may result in personal injury.

STEP 1



STEP 2

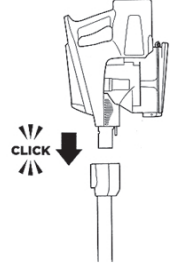

NOTE: Before vacuuming your delicate area rugs or carpet, refer to the manufacturer's recommended cleaning instructions.

- 1 Insert the wand into the motorized floor nozzle connector until you hear a click.

- 2 Insert the handheld vacuum into the top of the wand until you hear a click.

CHOOSING THE APPROPRIATE SETTING

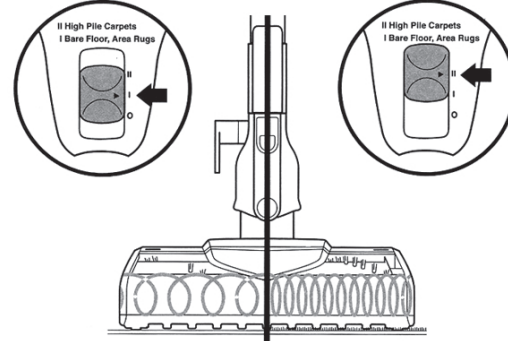

The Rocket™ has a 2-speed Power slider switch on the handle to select the speed of the brushroll. Slide the switch to appropriate speed setting (I or II) and start cleaning.

Bare Floor, Area Rugs (I) – The brushroll spins slowly to clean bare floors and delicate area rugs.

High Pile Carpets (II) – The brushroll spins faster to pick up debris below the surface of your carpets.

NOTE: For deep cleaning per ASTM F 608 (embedded dirt in carpets) please ensure setting is on high pile carpets (II).

USING THE DUST-AWAY™ HARD FLOOR ATTACHMENT

IMPORTANT: Do not use the Dust-Away Hard Floor Attachment without the microfiber pad.

NOTE: This vacuum has the reach to clean above floors or in tight spaces by using the wand. It's also a convenient handheld vacuum when using it without the wand.

NOTE: Both brushroll speeds provide the same suction power.

TIP: You can attach the handheld vacuum directly to the motorized floor nozzle for convenient stair cleaning.

STEP 1

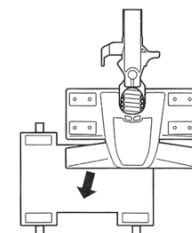

STEP 2

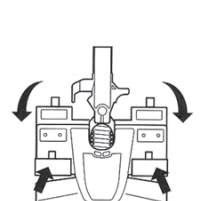

MICROFIBER PAD CARE

Machine or hand wash the pad separately in warm water with liquid detergent.

Do not use bleach or fabric softeners as they may damage the pad or leave a coating that will reduce its cleaning performance.

Tumble dry low or line dry to extend the life of the microfiber fabric.

For best results, replace your microfiber pad every 3 to 4 months.

Note: Your Quick Start Guide shows the accessories that are included with your model.

Note: Accessories may vary depending on model.

GETTING TO KNOW YOUR SHARK® ROCKET™

MAIN UNIT

- A Power Switch
- B Handheld Vacuum
- C Handheld Vacuum Catch
- D Dust Cup Release
- E Wand Release
- F Cord Hooks
- G Wand
- H Handheld Vacuum Storage Hook
- I Nozzle Release
- J Motorized Floor Nozzle

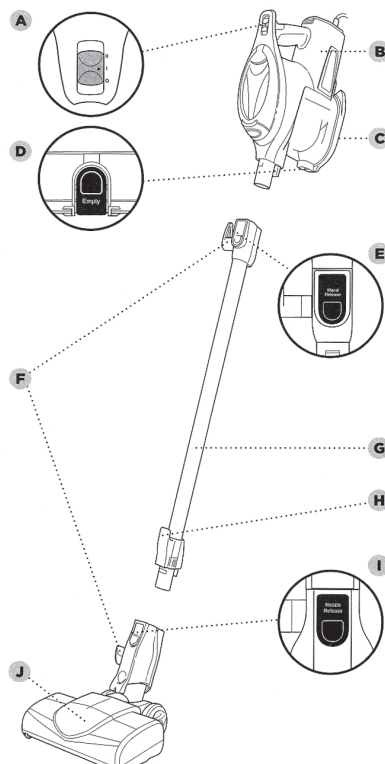

Note: Your Quick Start Guide shows the accessories that are included with your model.

Note: Accessories may vary depending on model.

USING YOUR VACUUM IN ABOVE-FLOOR MODE

STEP 1

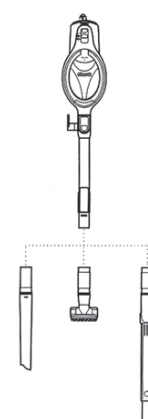

STEP 2



STEP 1



STEP 2

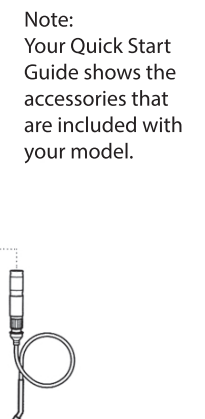

Note: Your Quick Start Guide shows the accessories that are included with your model.

WAND

- 1 While holding the vacuum upright, push the Nozzle Release button and pull the wand up to disconnect it from the floor nozzle.
- 2 Attach desired cleaning accessory.

HANDHELD

- 1 Press the Wand Release button on the top of the wand to disconnect it from the handheld vacuum.
- 2 Attach desired cleaning accessory.

STORAGE

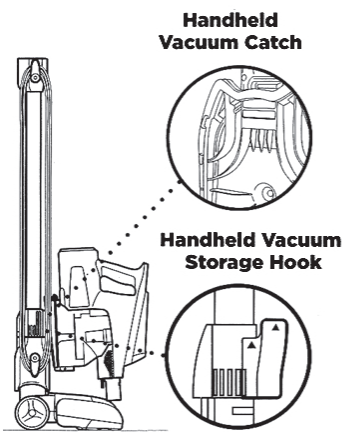

Press the Wand Release button on the top of the wand to release the handheld vacuum. There is a catch on the bottom of the handheld vacuum. Hang it from the hook located on the bottom portion of the wand. Wrap the cord around the two cord hooks.

MAINTAINING YOUR VACUUM

WARNING: To reduce the risk of shock and unintended operation, turn power off and unplug unit before servicing. Hand wash with water only to prevent damage from cleaning chemicals. Allow ALL filters to dry completely before replacing in the vacuum to prevent liquid from being drawn into electric parts.

IMPORTANT: Clean the dust screen inside the dust cup as required.

NOTE: Empty dust cup when debris reaches the MAX fill line.

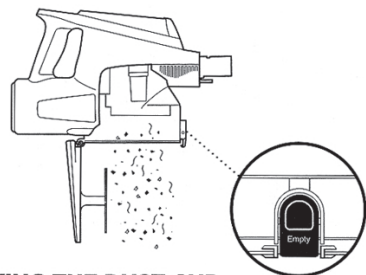

EMPTYING THE DUST CUP

- 1 Press the Wand Release button on the top of the wand to disconnect it from the handheld vacuum.
- 2 Hold the dust cup over a trash bin and press the "Empty" button on the front. The bottom lid will open, allowing the debris to fall out.
- 3 Once dust cup is empty, close the bottom lid.

RECOMMENDED FILTER CLEANING SCHEDULE:

Pre-Motor Filter Kit
(Foam & Felt)
XFFV300
Clean once a month.

Post-Motor Filter
XFFV300
Clean once a year.

Pre-Motor filters

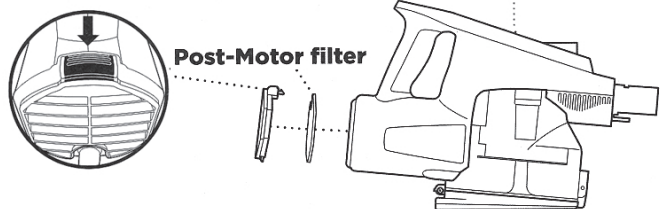
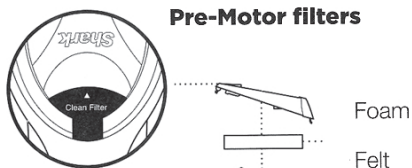

CLEANING THE FILTERS

1 Pre-Motor (foam and felt):

Access the foam and felt filters by lifting the latch on the top of the handheld vacuum. Remove and rinse the filters with water. Tap loose dirt off filters between washes as needed. Once completely dry, insert the felt filter first, then place the foam filter on top of it.

2 Post-Motor:

Access the filter behind the handle. Remove and rinse the filter with water. Re-install the filter housing, close the door until you hear a click.

REFURBISHED PRODUCT LIMITED NINETY DAYS WARRANTY

The **Refurbished Product Service Center** offers the following WARRANTY to the ORIGINAL purchaser of a product which we have refurbished.

This product that has been refurbished is warranted against any electronic or mechanical defects for a period of NINETY DAYS from the date of the original purchase by the consumer. Since this unit was sold as a refurbished item, the warranty does not apply to any cosmetic appearance items such as scratches. Should a defect occur, the **Refurbished Product Service Center** will repair or, at its option, replace defective unit/parts with new or rebuilt materials without charge for either parts or labor. Replacement unit/parts will be warranted for the remaining portion of the original warranty period.

This warranty does not cover installation or damage from accident, misuse, abuse, improper wiring, incorrect voltage, operating the unit against the instructions in the owner's manual or any product which has been opened, altered, or tampered with.

This warranty does not cover costs for removal and or installation of the unit for repair. Under no circumstances shall the service center be liable for any special, incidental or consequential damages or for any other expenses incurred by reason of use or sale of this product. This warranty is in lieu of any other warranties expressed or implied warranty of merchantability of fitness for particular use or otherwise.

This warranty gives the consumer specific legal rights and they may also have other rights which vary from State to State. Some States do not follow the exclusion or limitation of incidental or consequential damages, hence the above exclusion and limitations may not apply.

Refurbished Product Service Center
13225 Marquardt Avenue Santa Fe Springs, CA 90670.

WARRANTY REPAIR INFORMATION

If you need service on your unit and this product requires repair during the 90 days warranty period; please go to www.ConsumerServiceRefurbish.com or call the **Refurbished Product Service Center** at 562-946-3531 to obtain the required return authorization (RA) number. Pack the unit properly (the original carton is ideal for this purpose) along with a copy of your purchase receipt and a letter describing the problem. Send the unit freight prepaid and insured to:

Refurbished Product Service Center,
Att: Customer Service Department 13225 Marquardt Avenue Santa Fe Springs, CA 90670

Your unit will be promptly repaired and returned to you.

We will refuse to accept delivery of the returned unit unless the assigned RA number appears on the outside of the shipping carton.

Owner's Information (Keep for your permanent records)

NAME: _____
ADDRESS: _____
CITY: _____ STATE: _____ ZIP CODE: _____
PHONE: _____ E-MAIL: _____
MODEL: _____ SERIAL NO.: _____

MAINTAINING YOUR VACUUM

WARNING: Do not cut anything but the hair, fibers, or string that is on the brushroll.

TIP: Ensure the bottom of the floor nozzle is completely sealed and locked before using.

TIP: You do not need any tools to open the floor nozzle—just a coin.

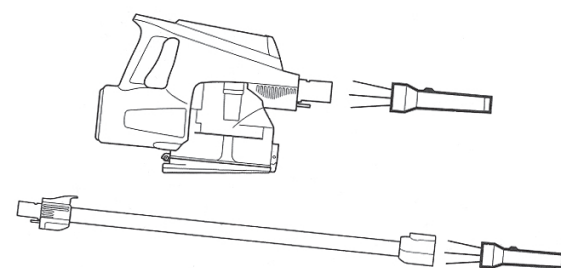

CHECKING FOR BLOCKAGES: HANDHELD AND WAND

- 1 Remove the wand from the handheld portion and check all dust cup intake openings.
- 2 Remove the floor nozzle from the wand and check the wand for blockages.

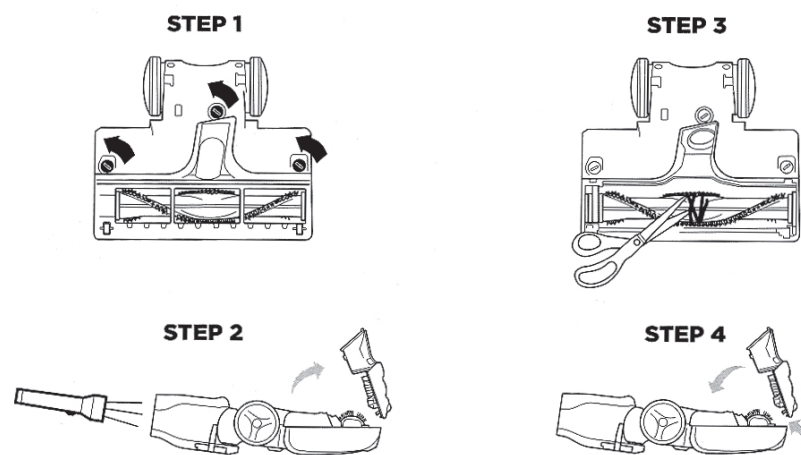

BOTTOM OF FLOOR NOZZLE

- 1 Use a coin to unlock the three locks on the bottom of the floor nozzle.
- 2 A portion of the base is removable to allow for better access to the brushroll and exposure to the airway. Shine a flashlight from the bottom to check for possible blockages in the airway.
- 3 Remove any string, carpet fibers, or hair that may be wrapped around the brushroll. There is a groove along the brushroll that allows a pair of scissors to cut across it to loosen up debris.
- 4 To re-assemble, replace base by lining it up along the front of the nozzle. Rotate down to snap into place until you hear a click. Lock the three locks.

TROUBLESHOOTING GUIDE

WARNING: To reduce the risk of shock and unintended operation, turn power off and unplug unit before servicing. Vacuum is not picking up debris. No suction or light suction. (Refer to Maintenance section for more information.)

- Check filters to see if they need cleaning. Follow instructions for rinsing and completely air-drying the filters before reinserting in the vacuum.
- Dust cup may be full; empty dust cup.
- Check floor nozzle for blockages; clear blockages if required.
- Remove any string, carpet fibers, or hair that may be wrapped around the brushroll.

Vacuum lifts area rugs.

- Suction is powerful. Take care when vacuuming area rugs or rugs with delicately sewn edges.
- Turn off the unit to disengage the brushroll and restart with the Power slider switch.

Brushroll does not spin.

- If Brushroll Indicator Light on the floor nozzle turns red, the brushroll has stopped spinning. Immediately turn off and unplug vacuum and remove blockage. Re-plug the unit into an electrical outlet and turn vacuum on.
- If Brushroll Indicator Light on the floor nozzle is green, the blockage has been successfully cleared. If the light is still red, please call a service center.

Dust cup bottom lid comes off.

If the hand vacuum was dropped or fell over, the dust cup bottom lid might come off. It can be re-attached by:

- Insert the back of the lid into the dust cup's metal rod attachment—push until a clicking sound is heard.
- Make sure the lid is able to seal and click closed with the dust cup.

Vacuum turns off on its own.

This vacuum is equipped with a motor-protective thermostat so the vacuum will shut off if it overheats. Should this occur, perform the following steps to restart the motor-protective thermostat:

1. Turn vacuum off and unplug it.
2. Empty dust cup and clean filters (see Maintenance section).
3. Check for blockages in hose, accessories, and inlet openings.
4. Allow unit to cool for a minimum of 45 minutes.
5. Plug in vacuum and turn it on.

Illustrations may differ from actual product. Shark and Rocket are registered trademarks of SharkNinja Operating LLC. For SharkNinja U.S. Patent information, visit sharkninja.com/USPatents.

Printed in Mexico
Sc: 08.13.2018

804109025



RE-DESIGN 09.23.2020-Pgs.:TAB
Obpn: HV300_Series_E_S_IB_170303
Shnmdl: HV300_BP