

Shark ROCKET® Cordless Vacuum



804109753

OWNER'S GUIDE

It's important to read this Owner's Guide prior to using your new product for the first time.

IMPORTANT SAFETY INSTRUCTIONS

FOR HOUSEHOLD USE ONLY • PLEASE READ ALL INSTRUCTIONS BEFORE USING THIS VACUUM.

If the charging cord plug does not fit fully into the outlet, reverse the plug. If it still does not fit, contact a qualified electrician. DO NOT force into outlet or try to modify to fit.

To reduce the risk of shock and unintended operation, turn off power and remove the battery before servicing.

WARNING

To reduce the risk of fire, electric shock, injury, or property damage:

THE FLOOR NOZZLE, WAND, AND HANDHELD VACUUM CONTAIN ELECTRICAL CONNECTIONS:

- This vacuum consists of a motorized nozzle, wand, and handheld vacuum. These components contain electrical connections, electrical wiring, and moving parts that potentially present risk to the user.
- Before each use, carefully inspect all parts for any damage. If a part is damaged, discontinue use.
- Use only identical replacement parts.
- This vacuum contains no serviceable parts.
- Use only as described in this manual. DO NOT use the vacuum for any purpose other than those described in this manual.
- With the exception of the filters and dust cup, DO NOT expose any parts of the vacuum to water or other liquids.
- Keep the appliance and its cord out of reach of children. Do not allow the appliance to be used by children. Do not allow to be used as a toy. Close supervision is necessary when used near children.

GENERAL USE

- This appliance can be used by persons with reduced physical, sensory or mental capabilities or lack of experience and knowledge if they have been given supervision or instruction concerning use of the appliance in a safe way and understand the hazards involved. Cleaning and user maintenance shall not be made by children.
- Always turn off the vacuum before connecting or disconnecting any current carrying hoses, motorized nozzles, chargers, batteries, or other electrical or mechanical parts.
- DO NOT handle plug or vacuum with wet hands.
- DO NOT use without dust cup, filters, and brushroll in place.
- Only use filters and accessories provided. Failure to do so will void the warranty.
- DO NOT put any objects into nozzle or accessory openings. DO NOT use with any opening blocked; keep free of dust, lint, hair, and anything that may reduce airflow.
- DO NOT use if nozzle or accessory airflow is restricted. If the air paths or the motorized floor nozzle become blocked, turn the vacuum off. Remove all obstructions before you turn on the unit again.
- Keep nozzle and all vacuum openings away from hair, face, fingers, uncovered feet, or loose clothing.
- DO NOT use if vacuum is not working as it should, or has been dropped, damaged, left outdoors, or dropped into water.
- Use extra care when cleaning on stairs.
- DO NOT leave the vacuum unattended while powered on.
- When powered on, keep the vacuum moving over the carpet surface at all times to avoid damaging the carpet fibers.
- DO NOT place vacuum on unstable surfaces such as chairs or tables.
- DO NOT use to pick up:
 - Liquids
 - Large objects
 - Hard or sharp objects (glass, nails, screws, or coins)
 - Large quantities of dust (including drywall, fireplace ash, or embers). DO NOT use as an attachment to power tools for dust collection.
 - Smoking or burning objects (hot coals, cigarette butts, or matches)
 - Flammable or combustible materials (lighter fluid, gasoline, or kerosene)
 - Toxic materials (chlorine bleach, ammonia, or drain cleaner)
- DO NOT use in the following areas:
 - Poorly lit areas
 - Wet or damp surfaces
 - Outdoor areas
 - Spaces that are enclosed and may contain explosive or toxic fumes or vapors (lighter fluid, gasoline, kerosene, paint, paint thinners, mothproofing substances, or flammable dust)
- Turn off the vacuum before plugging in or unplugging the charger.
- Turn off the vacuum before any adjustment, cleaning, maintenance or troubleshooting.
- During cleaning or routine maintenance, DO NOT cut anything other than hair, fibers, or string wrapped around the brushroll.
- Allow all filters to air-dry completely before replacing in the vacuum to prevent liquid from being drawn into electric parts.
- DO NOT modify or attempt to repair the vacuum or the battery yourself, except as indicated in this manual. DO NOT use the battery or vacuum if it has been modified or damaged. Damaged or modified batteries may exhibit unpredictable behavior resulting in fire, explosion or risk of injury.
- Turn off all controls before unplugging.
- Always turn off this appliance before connecting or disconnecting motorized nozzle or hand tool.

BATTERY PACK

- The battery is the power source for the vacuum. Carefully read and follow all charging instructions.
- To prevent unintentional starting, ensure the vacuum is powered off before picking up or carrying the vacuum. DO NOT carry the appliance with your finger on the power switch.
- Use only charger provided. Use of an incorrect charger may result in no charging, and/or unsafe conditions.
- Keep the battery away from all metal objects such as paper clips, coins, keys, nails, or screws. Shorting the battery terminals increases the risk of fire or burns.
- Under abusive conditions, liquid may be ejected from the battery. Avoid contact with this liquid, as it may cause irritation or burns. If contact occurs, flush with water. If liquid contacts eyes, seek medical help.
- Battery should not be stored at temperatures below 37.4°F (3°C) or above 104°F (40°C) to maintain long-term battery life.
- DO NOT charge battery at temperatures below 40°F (5°C) or above 104°F (40°C).
- Store the appliance indoors. DO NOT use or store it below 37.4°F (3°C). Ensure the appliance is at room temperature before operating.
- DO NOT expose the battery to fire or temperatures above 265°F (130°C) as it may cause explosion.

TECHNICAL SPECIFICATIONS

Voltage: 21.6V
Amps: 8.4A

SAVE THESE INSTRUCTIONS

ASSEMBLY

Your vacuum comes equipped with either a standard wand or a MultiFLEX® wand and either a standard floor nozzle or a Dirt Engage™ floor nozzle. All versions assemble the same way.

- Insert Wand into Floor Nozzle.
- Insert Handheld Vacuum into wand.

For proper operation, ensure all components are completely connected and clicked into place.

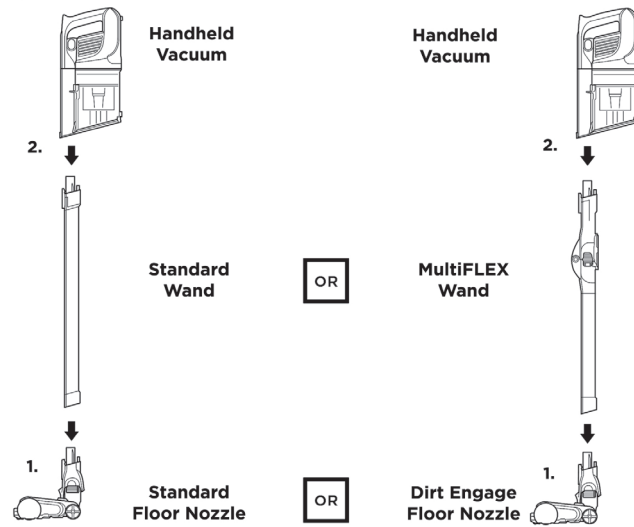

NOTE: Accessories may vary depending on the model. Refer to quick guide, if available. The images shown here are for illustrative purposes only and may be subject to change.

LI-ION BATTERY

Prior to first use, charge completely. A full charge takes approximately 3 hours.

LED BATTERY POWER AND CHARGING INDICATORS

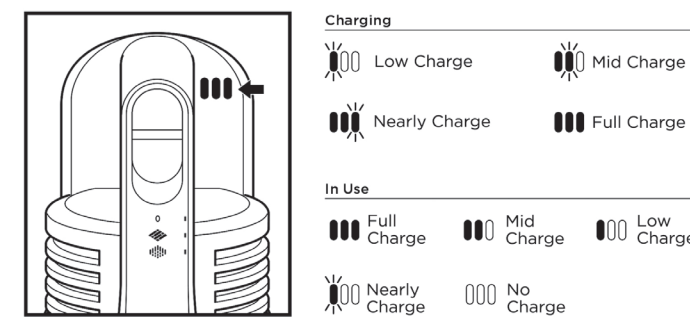

RECYCLING THE LI-ION BATTERY

When the Shark Li-ion battery needs to be replaced, dispose of it or recycle it in accordance with local ordinances or regulations. In some areas, it is illegal to place spent lithium-ion batteries in the trash or in a municipal solid waste stream. Return spent batteries to an authorized recycling center or to the retailer for recycling. Contact your local recycling center for information on where to drop off the spent battery.

NOTE: The Shark battery, like all lithium-ion batteries, will naturally decrease in capacity over time from the 100% capacity of a new battery.

CHARGING THE BATTERY

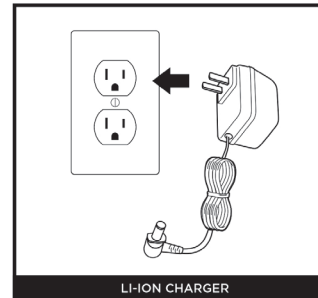

Plug the Li-ion Charger into a wall outlet.

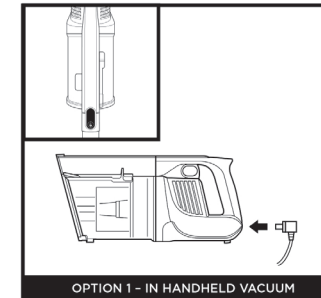

Remove the handheld vacuum from the wand by pressing the Wand Release button and pulling up. Plug the charger into the charging port on the handheld vacuum.

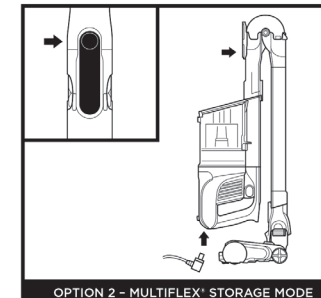

To put the vacuum in storage mode, press the MultiFLEX Wand Unlock Latch while folding the handheld vacuum forward until the wand clicks and locks. Plug the charger into the charging port on the handheld vacuum.

NOTE: MultiFLEX wand is not included with all configurations.

NOTE: Battery can only be charged in the vacuum.

POWER SETTINGS

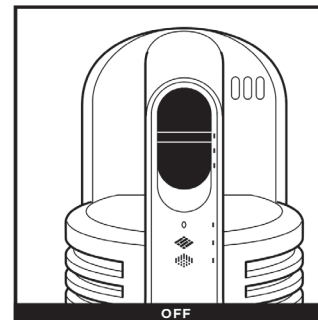

Slide switch to the top to turn off power. To begin vacuuming in Standard Mode, slide switch to the desired setting.

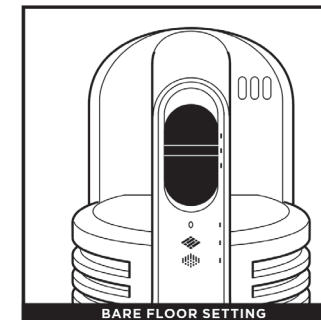

Bare Floor/Small Area Rugs Use this setting to clean bare floors and small area rugs.

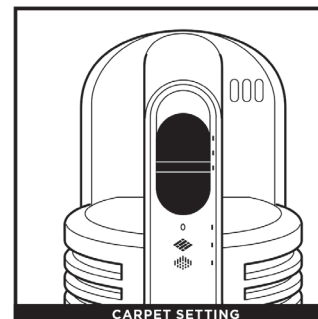

Carpet Use this setting to pick up debris below the surface of your carpets.

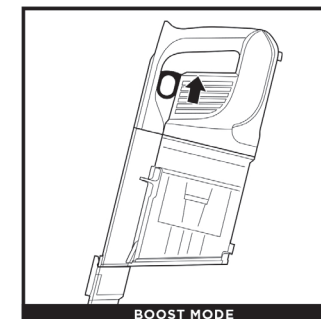

For an added boost in power, pull the Trigger on the handheld vacuum. Release it to return to standard power.

NOTE: For deep cleaning per ASTM F 608 (embedded dirt in carpets) please use setting II, Carpet. The Carpet setting should also be used when cleaning stuck-on dust and debris.

CLEANING MODES

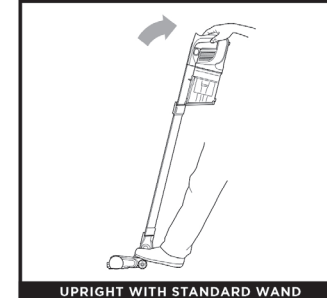

UPRIGHT WITH STANDARD WAND



UPRIGHT WITH MULTIFLEX® WAND

To clean floors, step on floor nozzle and tilt handheld vacuum back.

NOTE: Brushroll will only engage when the handheld vacuum and wand are tilted back.

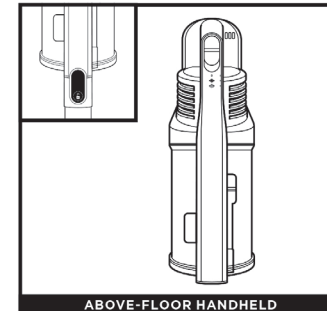

ABOVE-FLOOR HANDHELD

Press the wand release button and lift the handheld vacuum off the wand. Attach an accessory for great cleaning on stairs, furniture, and other above-floor areas.

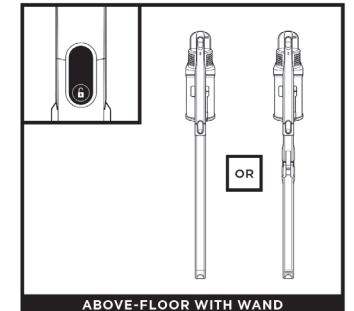

ABOVE-FLOOR WITH WAND

Stand the vacuum upright and press the nozzle release button located at the bottom of the wand, above the nozzle. Lift wand to detach. Great for cleaning baseboards, ceiling fans, window sills, and other hard-to-access areas.

NOTE: All accessories are compatible with both the wand and the handheld vacuum.

USING THE MULTIFLEX® WAND

MULTIFLEX REACH

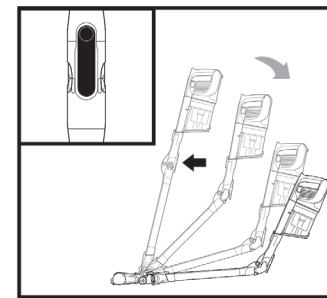

Press the unlock latch on the back of the wand, then adjust the angle.

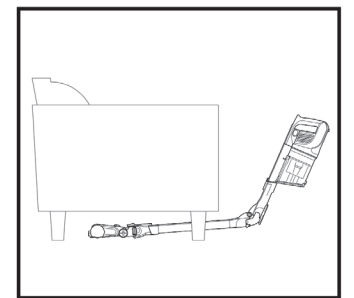

Adjust the wand to a lower angle to easily clean under furniture.

MULTIFLEX STORAGE

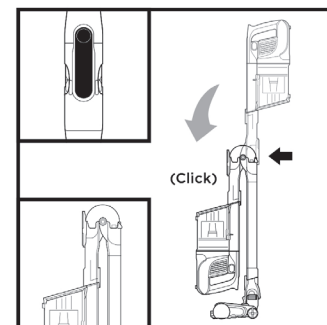

To put the vacuum in storage mode, press the unlock latch while folding the handheld vacuum forward until the wand clicks and locks.

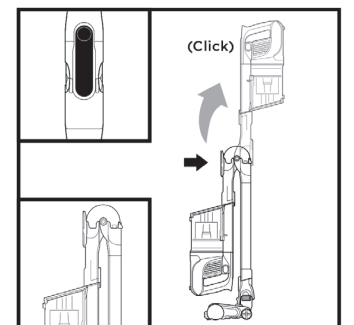

To take the vacuum out of storage mode, lift up the handheld vacuum until the wand clicks and locks in place.

NOTE: Not all units come with the MultiFLEX wand.

MAINTAINING YOUR VACUUM

EMPTYING THE DUST CUP

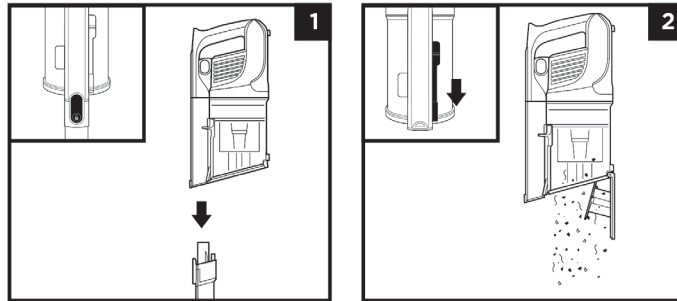

Press the wand release button to disconnect the handheld vacuum from the wand.

To empty the **Dust Cup** while it is attached to the handheld vacuum, position the dust cup over a trash receptacle and slide the **CleanTouch™ Lid Release** slider forward.

REMOVING AND CLEANING THE DUST CUP

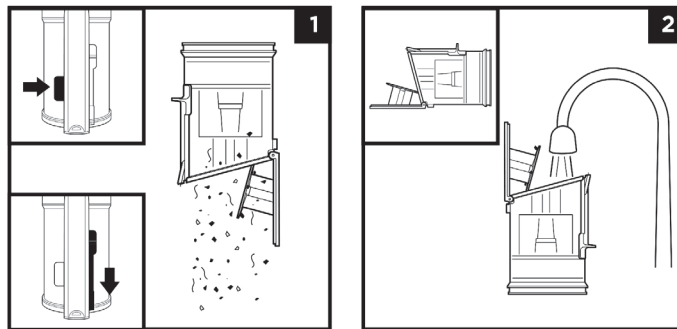

To remove the dust cup from the handheld vacuum, press the **Dust Cup Release** button near the handheld vacuum nozzle. Tilt the dust cup and lift off to remove.

To empty dust and debris, hold the dust cup over the trash, then slide the **Lid Release** slider forward.

To clean the interior of the dust cup, rinse it with water. Place it on its side to air-dry for at least 24 hours before reinstalling.

CLEANING THE FILTERS

To clean filters, rinse them with water only. Allow all filters to air-dry completely for at least 24 hours before reinstalling to prevent liquid from being drawn into electric parts. Clean the pre-motor filters at least once a month and post-motor filter at least once a year. Tap off loose dirt between washes when needed. More frequent cleaning may sometimes be necessary with heavy use. Cleaning the filters regularly helps maintain your vacuum's cleaning performance.

IMPORTANT: DO NOT use soap when cleaning the filters. Use water only.

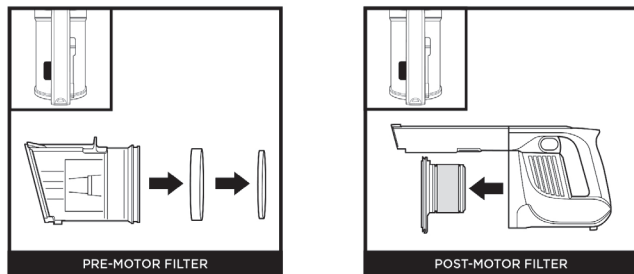

Press the dust cup release button and remove the dust cup. Pull the foam and felt filters out of the back of the dust cup.

Remove the dust cup. Pull the post-motor filter out of the handheld vacuum.

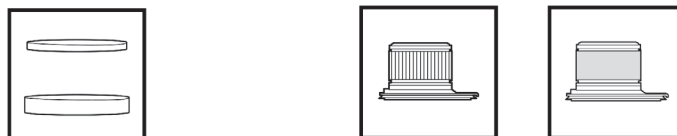

Pre-Motor Foam and Felt Filter Kit

Post-Motor HEPA Filter

Post-Motor Filter

NOTE: Not all units come with a HEPA filter.

MAINTAINING YOUR VACUUM - Cont.

FLOOR NOZZLE

If you run over a hard or sharp object or notice a noise change while vacuuming, check for blockages or objects caught in the brushroll.

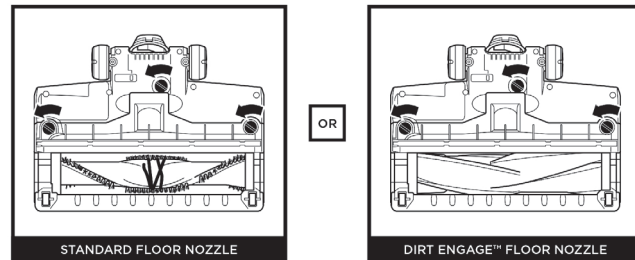

1. Turn off the vacuum.
2. Using a coin, turn locks counterclockwise to open, then lift off cover to access brushroll.
3. Clear airway of blockages.
4. Replace cover by sliding inserts into slots, then pressing down firmly on all sides before turning locks clockwise to close. There will be an audible click once the locks are secured.

CLEANING STANDARD BRUSHROLL

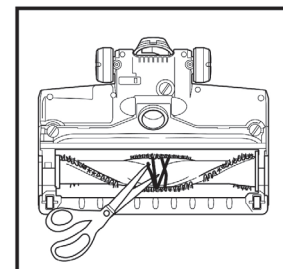

Remove any string, carpet fibers, or hair that may be wrapped around the brushroll by using scissors to help loosen debris.

CLEANING DIRT ENGAGE BRUSHROLL

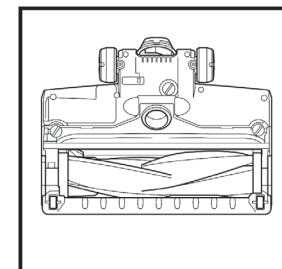

If any hair is wrapped around the brushroll, continue cleaning, using the Carpet setting on a bare floor surface, a low-pile carpet, or a small area rug. If some fibers remain wrapped around the brushroll after continued use, carefully remove them from the brushroll.

CHECKING FOR BLOCKAGES

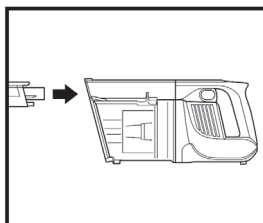

Checking for Blockages in the Handheld Vacuum:

1. Turn off vacuum.
2. Remove the handheld vacuum from the wand.
3. Check all intake openings to the dust cup and remove any debris or blockage.

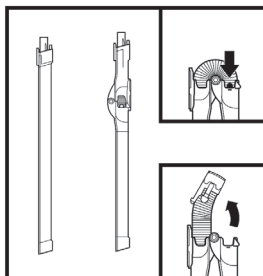

Checking for Blockages in the Wand:

- | | |
|---|---|
| Standard Wand: | MultiFLEX® Wand: |
| <ol style="list-style-type: none"> 1. Turn off vacuum 2. Remove the handheld vacuum and floor nozzle 3. Check intake openings for blockages and debris 4. Clear away debris and blockages | <ol style="list-style-type: none"> 1. Turn off vacuum 2. Remove the handheld vacuum and floor nozzle from the wand 3. Check the Clog Access on the MultiFLEX portion of the wand by pinching the tabs on both sides of the hose and lifting the hose out. 4. Clear any debris and blockages. |

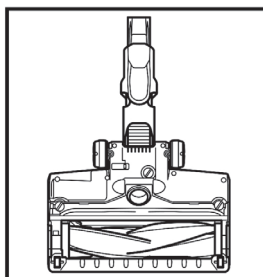

Checking for Blockages in the Floor Nozzle:

1. Turn off vacuum
2. Detach the wand
3. Use the edge of a coin to open the three locks on the bottom of the floor nozzle
4. Remove the cover and tilt back the neck of the floor nozzle
5. Check the opening and remove any debris or blockages
6. Replace cover by firmly pressing down on all sides and turning the locks clockwise to close

MAINTAINING YOUR VACUUM

TROUBLESHOOTING

WARNING: To reduce the risk of shock and unintended operation, turn off power and remove the battery before servicing.

Vacuum is not picking up debris. No suction or light suction. Nozzle light is red. (Refer to Checking for Blockages section for more information.)

- Dust cup may be full; empty dust cup.
- Check floor nozzle for blockages; clear blockages if required.
- Remove any string, carpet fibers, or hair that may be wrapped around the brushroll.
- Check connection between handheld vacuum and wand for blockages; clear blockages if required.
- Check clog access in wand for any blockages and clear any debris.
- Check filters to see if they need cleaning. Follow instructions for rinsing and completely air-drying the filters before reinserting in the vacuum.

Vacuum lifts area rugs.

- Make sure you are not engaging boost mode. Take care when vacuuming area rugs or rugs with delicately sewn edges.
- Turn off the unit to disengage the brushroll and restart with the power/selecter switch.

Brushroll does not spin.

- Immediately turn off the vacuum. Remove any blockages before turning the vacuum back on. Make sure the handheld vacuum is tilted back far enough for the brushroll to engage while in use.
- If the floor nozzle has headlights and they are not illuminated, there is a connection issue between the handheld vacuum, wand, and nozzle. Try disconnecting and reattaching the pieces.

Vacuum turns off on its own.

There are several possible reasons for the vacuum turning off on its own, including blockages, battery issues, and overheating. If vacuum turns off on its own, perform the following steps:

1. Turn on the vacuum and check the battery indicator lights located on the handheld portion of the vacuum. If recharging is needed, plug in while vacuum is in the off position.
2. Empty dust cup and clean filters (See Emptying the Dust Cup and Cleaning the Filters sections).
3. Check wand, accessories, and inlet openings and remove any blockages.
4. Allow unit and battery to cool for at least 45 minutes, until they return to room temperature.
5. Restart with power/selecter switch.

NOTE: If vacuum still does not operate properly, contact a service center.

Battery Indicator Lights on handheld vacuum are flashing.

- Bottom LED light is flashing (Fig. A): Battery needs to be charged.
- Top and bottom LED lights are flashing (Fig. B): Battery temperature is not optimal, so charging is temporarily paused. Leave battery plugged in and charging will resume soon.
- If top 2 or bottom 2 LED lights are flashing (Fig. C, Fig. D), contact a service center.

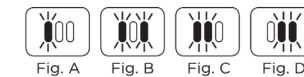

PLEASE READ CAREFULLY AND KEEP FOR FUTURE REFERENCE.

This Owner's Guide is designed to help you keep your vacuum running at peak performance.

BATTERY REMOVAL AND DISPOSAL

This product uses a lithium-ion rechargeable and recyclable battery. When the battery no longer holds a charge, it should be removed from the vacuum and recycled. **DO NOT** incinerate or compost the battery.

When your lithium-ion battery needs to be replaced, dispose of it or recycle it in accordance with local ordinances or regulations. In some areas, it is illegal to place spent lithium-ion batteries in the trash or in a municipal solid waste stream. Return spent battery to an authorized recycling center or to retailer for recycling. Contact your local recycling center for information on where to drop off the spent battery.

The RBRC™ (Rechargeable Battery Recycling Corporation) seal on the lithium-ion battery indicates that the costs to recycle the battery at the end of its useful life have already been paid by SharkNinja. In some areas, it is illegal to place spent lithium-ion batteries in the trash or municipal solid waste stream and the RBRC program provides an environmentally conscious alternative.

RBRC, in cooperation with SharkNinja and other battery users, has established programs in the United States and Canada to facilitate the collection of spent lithium-ion batteries. Help protect our environment and conserve natural resources by returning the spent lithium-ion battery to an authorized SharkNinja service center or to your local retailer for recycling. You may also contact your local recycling center for information on where to drop off the spent battery, or call 1-800-798-7398.

REFURBISHED PRODUCT LIMITED NINETY DAYS WARRANTY

The **Refurbished Product Service Center** offers the following WARRANTY to the ORIGINAL purchaser of a product which we have refurbished.

This product that has been refurbished is warranted against any electronic or mechanical defects for a period of NINETY DAYS from the date of the original purchase by the consumer. Since this unit was sold as a refurbished item, the warranty does not apply to any cosmetic appearance items such as scratches. Should a defect occur, the **Refurbished Product Service Center** will repair or, at its option, replace defective unit/parts with new or rebuilt materials without charge for either parts or labor. Replacement unit/parts will be warranted for the remaining portion of the original warranty period.

This warranty does not cover installation or damage from accident, misuse, abuse, improper wiring, incorrect voltage, operating the unit against the instructions in the owner's manual or any product which has been opened, altered, or tampered with.

This warranty does not cover costs for removal and or installation of the unit for repair. Under no circumstances shall the service center be liable for any special, incidental or consequential damages or for any other expenses incurred by reason of use or sale of this product. This warranty is in lieu of any other warranties expressed or implied warranty of merchantability of fitness for particular use or otherwise.

This warranty gives the consumer specific legal rights and they may also have other rights which vary from State to State. Some States do not follow the exclusion or limitation of incidental or consequential damages, hence the above exclusion and limitations may not apply.

Refurbished Product Service Center
13225 Marquardt Avenue Santa Fe Springs, CA 90670.

WARRANTY REPAIR INFORMATION

If you need service on your unit and this product requires repair during the 90 days warranty period; please go to www.ConsumerServiceRefurbish.com or call the **Refurbished Product Service Center** at 562-946-3531 to obtain the required return authorization (RA) number. Pack the unit properly (the original carton is ideal for this purpose) along with a copy of your purchase receipt and a letter describing the problem. Send the unit freight prepaid and insured to:

Refurbished Product Service Center,
Att: Customer Service Department 13225 Marquardt Avenue Santa Fe Springs, CA 90670

Your unit will be promptly repaired and returned to you. We will refuse to accept delivery of the returned unit unless the assigned RA number appears on the outside of the shipping carton.

Owner's Information
(Keep for your permanent records)

NAME: _____
ADDRESS: _____
CITY: _____ STATE: _____ ZIP CODE: _____
PHONE: _____ E-MAIL: _____
MODEL: _____ SERIAL NO.: _____



PLEASE READ CAREFULLY AND KEEP FOR FUTURE REFERENCE.

This Owner's Guide is designed to help you get a complete understanding of your new Shark® vacuum.

SharkNinja Operating LLC
US: Needham, MA 02494

Illustrations may differ from actual product. We are constantly striving to improve our products; therefore the specifications contained herein are subject to change without notice.

For SharkNinja U.S. Patent information, visit sharkninja.com/uspatents

© 2019 SharkNinja Operating LLC. MULTIFLEX, ROCKET, and SHARK are registered trademarks of SharkNinja Operating LLC. CLEAN TOUCH and DIRT ENGAGE are trademarks of SharkNinja Operating LLC. RBRC is a trademark of Rechargeable Battery Recycling Corporation.

804109753 PRINTED IN MEXICO Elbrd: Y.T.
OBPN: IX-Z140SERIES_IB_E_PP_MV8_190531
SC: 06-02-2020_TAB MODEL: IX141_26_BP

QUICK START GUIDE

WHAT'S INSIDE

- A Handheld Vacuum
- B Motorized Floor Nozzle
- C Wand
- D Pet Multi-Tool
- E Duster Crevice Tool
- F Li-Ion Charger
- G Post-Motor Filter (Pre-Installed)

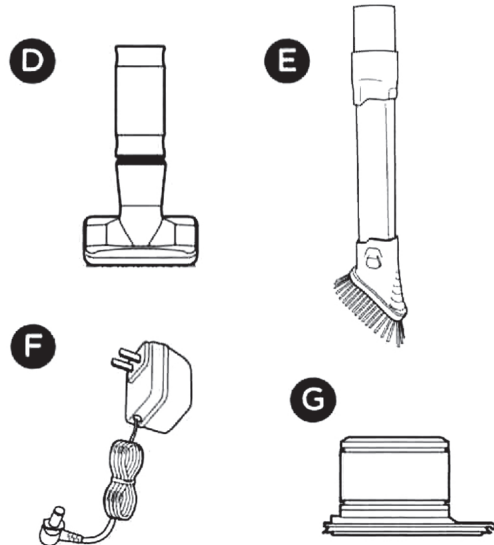

* Accessories may vary depending on the model.

ASSEMBLY

1. Insert **Wand** into **Floor Nozzle**.
2. Insert **Handheld Vacuum** into wand.

For proper operation, ensure all components are completely connected and clicked into place.

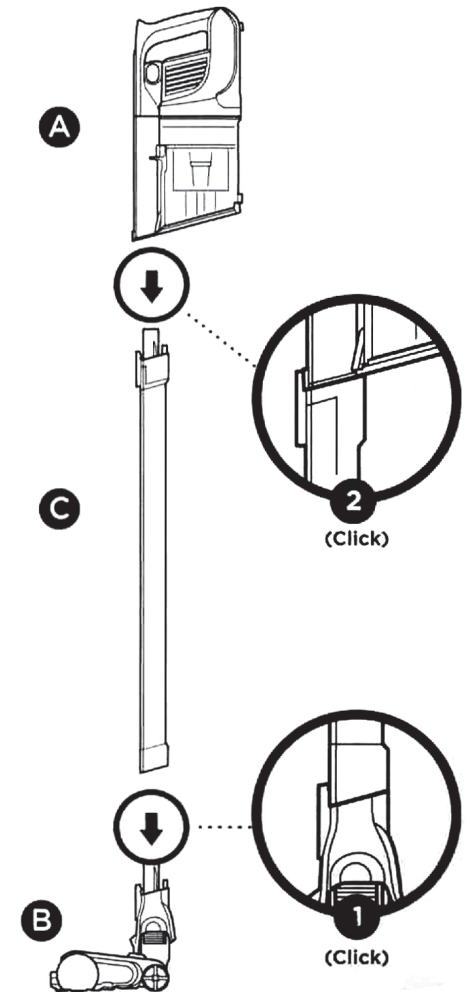

804006589



PRINTED IN MEXICO / SC:22-09-2021 / 0.5P / ELBRD: J.E.
SHNML: IX142_B / OBPN:N/A