

CLEANING AND REPLACING THE FILTERS

CLEANING FILTERS

Regularly rinse and replace the filters to maintain your vacuum's suction power.

To rinse filters, use cold water only to prevent damage from cleaning chemicals. Allow all filters to air-dry for at least 24 hours before reinstalling them to prevent liquid from being drawn into electronic parts.

IMPORTANT: DO NOT use soap when cleaning the filters.

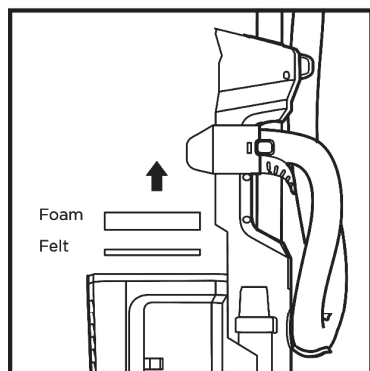

RINSE PRE-MOTOR FILTERS EVERY MONTH

Remove **Dust Cup**, then lift out **Filters**.

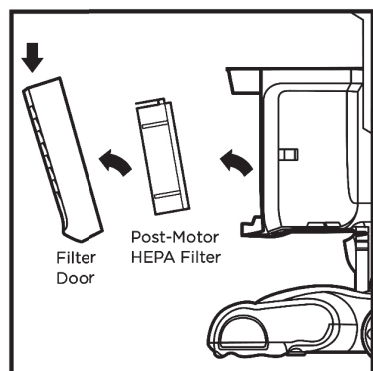

RINSE HEPA FILTER EVERY YEAR

Tilt **Filter Door** and firmly pull it off. Press tab at top of **HEPA Filter** and pull out filter. To reinstall, insert HEPA filter into unit and replace the filter door.

MAINTENANCE

CLEANING THE BRUSHROLL

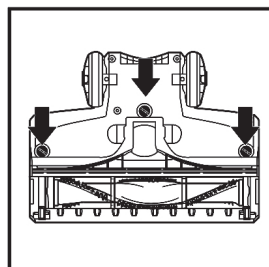

Using a coin, turn locks counterclockwise, then lift the cover to access brushroll.

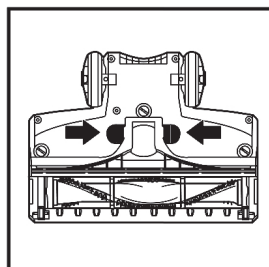

DEBRIS WRAPPED AROUND BRUSHROLL

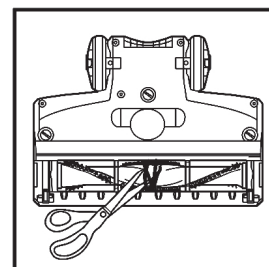

Clean off any debris on the bristles.

DEBRIS BEHIND BRUSHROLL

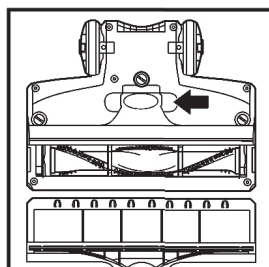

If you run over a hard or sharp object or notice a noise change while vacuuming, check for blockages or objects caught behind the brushroll.

Clear away any dust, dirt, or blockages in **Debris Intake**.

To close the cover, push down until it clicks into place. Close the locks by using a coin to turn them clockwise.

Note: The images shown here are for illustrative purposes only and may be subject to change.

CHECKING FOR BLOCKAGES

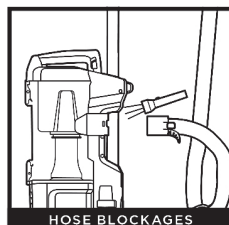

HOSE BLOCKAGES

Detach hose from vacuum pod, and check hose and opening on back of pod for blockages.

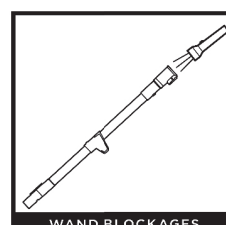

WAND BLOCKAGES

Detach wand from pod and handle, and check both ends for blockages.

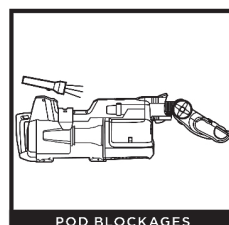

POD BLOCKAGES

Detach wand from pod, and check opening for blockages.

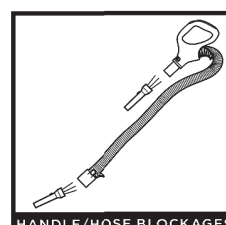

HANDLE/HOSE BLOCKAGES

Detach handle from wand and hose from the vacuum pod, and check openings for blockages.

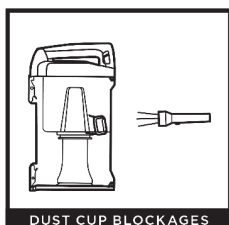

DUST CUP BLOCKAGES

Detach dust cup from vacuum pod. Empty dust cup, remove debris from lint screen, and check for blockages.

Note: The image shown here is for illustrative purposes only and may be subject to change. The actual number of accessories may vary depending on the model.

TROUBLESHOOTING

Vacuum is not picking up debris. No suction or light suction.

- Check filters to see if they need cleaning. Follow instructions for rinsing and air-drying the filters before reinserting in the vacuum.
- Dust cup may be full; empty dust cup.
- Check hose, hose connections, nozzle, wand, pod, and accessories for blockages. Clear any blockages found.
- If any string, hair, or carpet fibers are wrapped around the brushroll, remove the floor nozzle cover and carefully cut debris with scissors and remove from brushroll. See Cleaning the Brushroll section for more information.

Vacuum lifts area rugs.

- Make sure Power/Surface switch is set to Hard Floor (setting I).
- Rotate suction control slider to MIN.
- Suction is powerful. Take care when vacuuming area rugs or rugs with delicately sewn edges.

Brushroll does not spin in carpet cleaning mode.

- If the Brushroll Indicator Light turns red, immediately turn off and unplug the vacuum. Remove pod from floor nozzle and clear any blockages. Reconnect nozzle, plug in vacuum, and turn on power.
- With the power on, recline the handle, which will automatically turn on the brushroll.
- Ensure that the Power/Surface switch is set to Carpet (setting II) for brushroll to spin.

Vacuum turns off on its own or indicator light flashes red.

This vacuum is equipped with a motor-protective thermostat. If your vacuum overheats, the thermostat will automatically turn the suction motor off. Perform the following steps to restart the thermostat:

1. Turn vacuum off and unplug it.
2. Empty dust cup and clean filters (see Emptying the Dust Cup and Cleaning the Filters).
3. Check for blockages in hose, accessories, and inlet openings.
4. Allow unit to cool for a minimum of 45 minutes.
5. Plug in vacuum and restart with the Power/Surface switch.

REFURBISHED PRODUCT LIMITED NINETY DAYS WARRANTY

The **Refurbished Product Service Center** offers the following WARRANTY to the ORIGINAL purchaser of a product which we have refurbished.

This product that has been refurbished is warranted against any electronic or mechanical defects for a period of NINETY DAYS from the date of the original purchase by the consumer. Since this unit was sold as a refurbished item, the warranty does not apply to any cosmetic appearance items such as scratches. Should a defect occur, the **Refurbished Product Service Center** will repair or, at its option, replace defective unit/parts with new or rebuilt materials without charge for either parts or labor. Replacement unit/parts will be warranted for the remaining portion of the original warranty period.

This warranty does not cover installation or damage from accident, misuse, abuse, improper wiring, incorrect voltage, operating the unit against the instructions in the owner's manual or any product which has been opened, altered, or tampered with.

This warranty does not cover costs for removal and or installation of the unit for repair. Under no circumstances shall the service center be liable for any special, incidental or consequential damages or for any other expenses incurred by reason of use or sale of this product. This warranty is in lieu of any other warranties expressed or implied warranty of merchantability of fitness for particular use or otherwise.

This warranty gives the consumer specific legal rights and they may also have other rights which vary from State to State. Some States do not follow the exclusion or limitation of incidental or consequential damages, hence the above exclusion and limitations may not apply.

Refurbished Product Service Center
13225 Marquardt Avenue Santa Fe Springs, CA 90670.

WARRANTY REPAIR INFORMATION

If you need service on your unit and this product requires repair during the 90 days warranty period; please go to www.ConsumerServiceRefurbish.com or call the **Refurbished Product Service Center** at 562-946-3531 to obtain the required return authorization (RA) number. Pack the unit properly (the original carton is ideal for this purpose) along with a copy of your purchase receipt and a letter describing the problem. Send the unit freight prepaid and insured to:

Refurbished Product Service Center,
Att: Customer Service Department 13225 Marquardt Avenue Santa Fe Springs, CA 90670

Your unit will be promptly repaired and returned to you. We will refuse to accept delivery of the returned unit unless the assigned RA number appears on the outside of the shipping carton.

Owner's Information
(Keep for your permanent records)

NAME: _____

ADDRESS: _____

CITY: _____

STATE: _____ ZIP CODE: _____

PHONE: _____

E-MAIL: _____

MODEL: _____

SERIAL NO.: _____

Printed in Mexico

Sc: 02.26.2020

Pgs.:TAB

Obpn:NV150Series_IB_MP_Mv2_190614

Shnmdl: NV150_BP

elbrd:i.a.

804109767

TECHNICAL SPECIFICATIONS

Voltage: 120V, 60Hz

Amps: 5.8A



Please be sure to read the enclosed Shark® Owner's Guide prior to using your unit.

Shark Navigator™ SWIVEL PRO COMPLETE

QUICK START GUIDE

WHAT'S INSIDE

- A** Vacuum Pod
- B** Handle & Hose
- C** Wand
- D** Crevice Tool
- E** Dusting Brush
- F** Upholstery Tool

ASSEMBLY

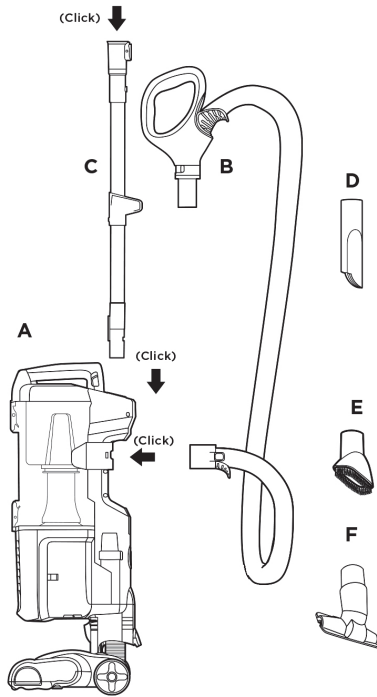

NOTE: For proper operation, ensure all parts are firmly **CLICKED** into place.

EMPTYING THE DUST CUP

Empty the dust cup after each use.

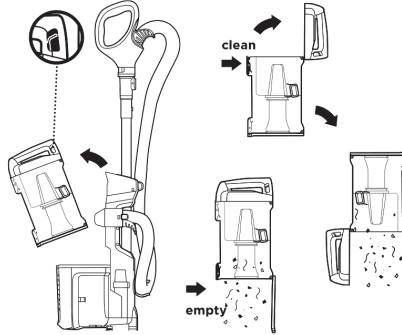

MAINTENANCE

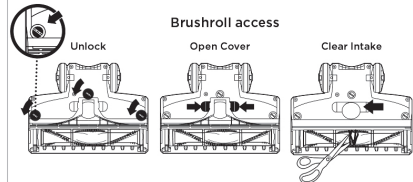
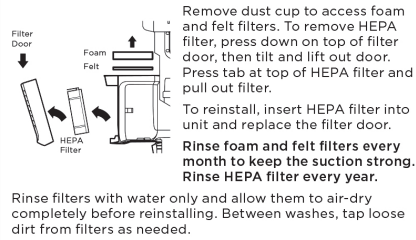

Use a coin to turn the locks counterclockwise until they click open, then lift the cover to access the brushroll. Clear the debris intake.

2 WAYS TO CLEAN

FLOOR CLEANING

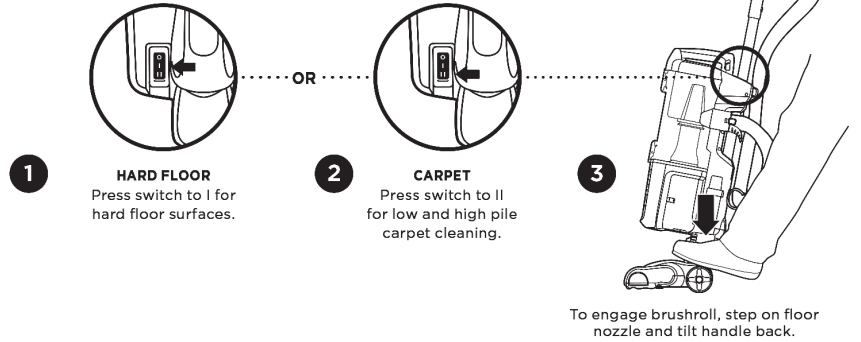

ABOVE-FLOOR CLEANING

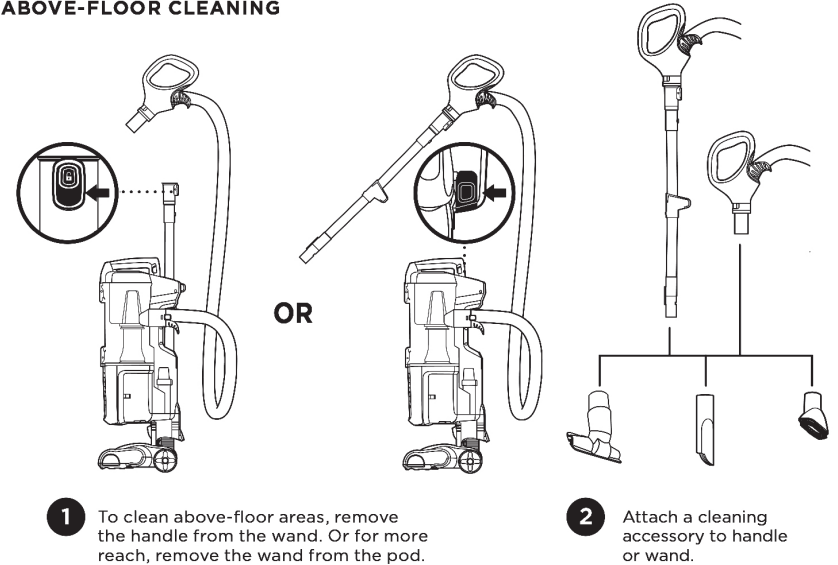

Accessory type and quantity may vary depending on the model.

Accessory type and quantity may vary depending on the model. The images shown here are for illustrative purposes only and may be subject to change.

804009767

Printed in Mexico
Sc: 02.27.2020/Pgs.:1/Obpn:NV150_QSG_MP_Mv1_190610/Shnmdl: NV150_BP - elbrd.i.a.

804009767