

LG OLED TV

OWNER'S MANUAL

Safety and Reference

Please read this manual carefully before operating your set and retain it for future reference.

- OLED48A2AUA
- OLED48A2PUA
- OLED55A2AUA
- OLED55A2PUA
- OLED65A2AUA
- OLED65A2PUA
- OLED77A2AUA
- OLED77A2PUA
- OLED55B2AUA
- OLED55B2PUA
- OLED65B2AUA
- OLED65B2PUA
- OLED77B2AUA
- OLED77B2PUA
- OLED42C2AUA
- OLED42C2PUA
- OLED48C2AUA
- OLED48C2PUA
- OLED55C2AUA
- OLED55C2PUA
- OLED65C2AUA
- OLED65C2SW
- OLED65C2PUA
- OLED77C2AUA
- OLED77C2PUA
- OLED83C2AUA
- OLED83C2PUA

Important Safety Instruction

- Read these instructions.
- Keep these instructions.
- Heed all warnings.
- Follow all instructions.
- Do not use this apparatus near water.
- Clean only with dry cloth.
- Do not block any ventilation openings. Install in accordance with the manufacturer's instructions.
- Do not install near any heat sources such as radiators, heat registers, stoves, or other apparatus (including amplifiers) that produce heat.
- Do not defeat the safety purpose of the polarized or grounding-type plug. A polarized plug has two blades with one wider than the other. A grounding type plug has two blades and a third grounding prong. The wide blade or the third prong are provided for your safety. If the provided plug does not fit into your outlet, consult an electrician for replacement of the obsolete outlet.
- Protect the power cord from being walked on or pinched particularly at plugs, convenience receptacles, and the point where they exit from the apparatus.
- Only use attachments/accessories specified by the manufacturer.
- Use only with the cart, stand, tripod, bracket, or table specified by the manufacturer, or sold with the apparatus. When a cart is used, use caution when moving the cart/apparatus combination to avoid injury from tip-over.



- Unplug this apparatus during lightning storms or when unused for long periods of time.
- Refer all servicing to qualified service personnel. Servicing is required when the apparatus has been damaged in any way, such as power-supply cord or plug is damaged, liquid has been spilled or objects have fallen into the apparatus, the apparatus has been exposed to rain or moisture, does not operate normally, or has been dropped.

By using this product, you agree that all disputes between you and LG arising out of or relating in any way to this product (including but not limited to warranty disputes) shall be resolved exclusively through binding arbitration on an individual basis. The terms of the arbitration agreement (including details on the procedure for resolving disputes) is available at www.lg.com/us/arbitration (USA) or www.lg.com/ca_en/arbitration (Canada).

Before reading this manual

- Read this manual thoroughly before operating your TV, and keep it for future reference.
- On the website you can download the manual including installation, using, troubleshooting, specifications, license etc and view its contents on your PC or mobile device.
- **User Guide** : For more information about this TV, read the USER GUIDE embedded in the product. (Depending upon model)
 - To open the USER GUIDE (⊗) / (⊗) → (⊙) → [Support] → [User Guide]

Optional Extras

- Optional extras can be changed or modified for quality improvement without any notification. Contact your dealer for buying these items. These devices work only with certain models.
- The model name or design may be changed due to the manufacturer's circumstances or policies.
- A cable to connect antennas and external devices must be purchased separately.

✔ Note

- Product specifications or contents of this manual may be changed without prior notice due to upgrade of product functions.
- The items supplied with your product may vary depending upon the model.
- Image shown may differ from your TV.

Warning! Safety instructions



CAUTION: TO REDUCE THE RISK OF ELECTRIC SHOCK DO NOT REMOVE COVER (OR BACK). NO USER SERVICEABLE PARTS INSIDE. REFER TO QUALIFIED SERVICE PERSONNEL.



The symbol is intended to alert the user to the presence of uninsulated dangerous voltage within the product's enclosure that may be of sufficient magnitude to constitute a risk of electric shock to persons.



The symbol is intended to alert the user to the presence of important operating and maintenance (servicing) instructions in the literature accompanying the device.

WARNING: TO REDUCE THE RISK OF FIRE AND ELECTRIC SHOCK, DO NOT EXPOSE THIS PRODUCT TO RAIN OR MOISTURE.

- TO PREVENT THE SPREAD OF FIRE, KEEP CANDLES OR OTHER ITEMS WITH OPEN FLAMES AWAY FROM THIS PRODUCT AT ALL TIMES.
 - **Do not place the TV and/or remote control in the following environments:**
 - Keep the product away from direct sunlight.
 - An area with high humidity such as a bathroom.
 - Near any heat source such as stoves and other devices that produce heat.
 - Near kitchen counters or humidifiers where they can easily be exposed to steam or oil.
 - An area exposed to rain or wind.
 - Do not expose to dripping or splashing and do not place objects filled with liquids, such as vases, cups, etc. on or over the apparatus (e.g., on shelves above the unit).
 - Near flammable objects such as gasoline or candles, or expose the TV to direct air conditioning.
 - Do not install in excessively dusty places.
- Otherwise, this may result in fire, electric shock, combustion/explosion, malfunction or product deformation.
- **Ventilation**
 - Install your TV where there is proper ventilation. Do not install in a confined space such as a bookcase.
 - Do not install the product on a carpet or cushion.
 - Do not block or cover the product with cloth or other materials while unit is plugged in.
 - Take care not to touch the ventilation openings. When watching the TV for a long period, the ventilation openings may become hot.
 - Protect the power cord from physical or mechanical abuse, such as being twisted, kinked, pinched, closed in a door, or walked upon. Pay particular attention to plugs, wall outlets, and the point where the cord exits the device.
 - Do not move the TV whilst the Power cord is plugged in.
 - Do not use a damaged or loosely fitting power cord.
 - Be sure to grasp the plug when unplugging the power cord. Do not pull on the power cord to unplug the TV.
 - Do not connect too many devices to the same AC power outlet as this could result in fire or electric shock.
 - **Disconnecting the Device from the Main Power**
 - The power plug is the disconnecting device. In case of an emergency, the power plug must remain readily accessible.
 - Do not let your children climb or cling onto the TV. Otherwise, the TV may fall over, which may cause serious injury.
 - **Outdoor Antenna Grounding** (Can differ by country):
 - If an outdoor antenna is installed, follow the precautions below. An outdoor antenna system should not be located in the vicinity of overhead power lines or other electric light or power circuits, or where it can come in contact with such power lines or circuits as death or serious injury can occur. Be sure the antenna system is grounded to provide some protection against voltage surges and built-up static charges. Section 810 of the National Electrical Code (NEC) in the U.S.A. provides information with respect to proper grounding of the mast and supporting structure, grounding of the lead-in wire to an antenna discharge unit, size of grounding conductors, location of antenna discharge unit, connection to grounding electrodes and requirements for the grounding electrode. Antenna grounding according to the National Electrical Code, ANSI/NFPA 70
 - Never touch this apparatus or antenna during a lightning storm. You may be electrocuted.
 - Make sure the power cord is connected securely to the TV and wall socket if not secured damage to the Plug and socket may occur and in extreme cases a fire may break out.
 - Do not insert metallic or inflammable objects into the product. If a foreign object is dropped into the product, unplug the power cord and contact a service center.
 - Do not touch the end of the power cord while it is plugged in. You may be electrocuted.

- **If any of the following occur, unplug the product immediately and contact a service center.**
 - The product has been damaged.
 - If water or another substance enters the product (like an AC adapter, power cord, or TV).
 - If you smell smoke or other odors coming from the TV
 - When lightning storms or when unused for long periods of time. Even the TV is turned off by remote control or button, AC power source is connected to the unit if not unplugged in.
- Do not use high voltage electrical equipment near the TV (e.g., a bug zapper). This may result in product malfunction.
- Do not attempt to modify this product in any way without written authorization from LG Electronics. Accidental fire or electric shock can occur. Contact a service center. Unauthorized modification could void the user's authority to operate this product.
- Use only an authorized attachments / accessories approved by LG Electronics. Otherwise, this may result in fire, electric shock, malfunction, or product damage.
- Never disassemble the AC adapter or power cord. This may result in fire or electric shock.
- Handle the adapter carefully to avoid dropping or striking it. An impact could damage the adapter.
- To reduce the risk of fire or electrical shock, do not touch the TV with wet hands. If the power cord prongs are wet or covered with dust, dry the power plug completely or wipe dust off.
- **Batteries not included.**
 - Store the accessories (battery, etc.) in a safe location out of the reach of children.
 - Do not short circuit, disassemble, or allow the batteries to overheat. Do not dispose of batteries in a fire. Batteries should not be exposed to excessive heat.
 - Caution: Risk of fire or explosion if the battery is replaced by an incorrect type.
- **Moving**
 - When moving, make sure the product is turned off, unplugged, and all cables have been removed. It may take 2 or more people to carry larger TVs. Do not press or put stress on the front panel of the TV. Otherwise, this may result in product damage, fire hazard or injury.
- Keep the packing anti-moisture material or vinyl packing out of the reach of children.
- Do not allow an impact shock, any objects to fall into the product, and do not drop anything onto the screen.
- Do not press strongly upon the panel with a hand or a sharp object such as a nail, pencil, or pen, or make a scratch on it. It may cause damage to screen.
- **Cleaning**
 - When cleaning, unplug the power cord and wipe gently with a soft/dry cloth. Do not spray water or other liquids directly on the TV. Do not clean your TV with chemicals including glass cleaner, any type of air freshener, insecticide, lubricants, wax (car, industrial), abrasive, thinner, benzene, alcohol etc., which can damage the product and/or its panel. Otherwise, this may result in electric shock or product damage.

Installation

Lifting and moving the TV

When moving or lifting the TV, read the following to prevent the TV from being scratched or damaged and for safe transportation regardless of its type and size.

- It is recommended to move the TV in the box or packing material that the TV originally came in.
- Before moving or lifting the TV, disconnect the power cord and all cables.
- When holding the TV, the screen should face away from you to avoid damage.
- Hold the side and bottom of the TV frame firmly. Make sure not to hold the transparent part, speaker, or speaker grille area.
- Use at least two people to move a large TV.
- When transporting the TV, do not expose the TV to jolts or excessive vibration.
- When transporting the TV, keep the TV upright; never turn the TV on its side or tilt towards the left or right.
- When handling the TV, be careful not to damage the protruding buttons.



- Avoid touching the screen at all times, as this may result in damage to the screen.
- Do not place the product on the floor with its front facing down without padding. Failure to do so may result in damage to the screen.
- When attaching the stand to the TV set, place the screen facing down on a cushioned table or flat surface to protect the screen from scratches.

Mounting on the Table

- 1 Lift and tilt the TV into its upright position on a table.
 - Leave a minimum of 10 cm (4 inches) space from the wall for proper ventilation.
- 2 Connect the power cord to a wall outlet.



- Do not apply foreign substances (oils, lubricants, etc.) to the screw parts when assembling the product. (Doing so may damage the product.)
- If you install the TV on a stand, you need to take actions to prevent the product from overturning. Otherwise, the product may fall over, which may cause injury.
- Do not use any unapproved items to ensure the safety and lifespan of the product.
- Any damages or injuries by using unapproved items are not covered by the warranty.
- When assembling the stand, ensure that all of the provided screws are attached. If the screws are not fully tightened, the product may tilt or tip over, resulting in damage. Tightening the screws with excessive force may cause them to come off due to abrasion of the screw joint.
- If there is a problem with swivel angle adjustment, lift the product slightly and put it back down (Depending upon model).

Securing TV to the Wall

- 1 Insert and tighten the eye-bolts or TV brackets and bolts on the back of the TV.
 - If there are bolts inserted at the eye-bolts position, remove the bolts first.
- 2 Mount the wall brackets with the bolts to the wall. Match the location of the wall bracket and the eye-bolts on the rear of the TV.
- 3 Connect the eye-bolts and wall brackets tightly with a sturdy rope or cable. Make sure to keep the rope parallel to the flat surface.
 - Use a platform or cabinet that is strong and large enough to support the TV securely.
 - Brackets, bolts, and ropes are optional. You can obtain additional accessories from your local dealer.

Mounting to the Wall (Wall mounting kit not included)

An optional wall mount can be used with your LG Television. Consult with your local dealer for a wall mount that supports the VESA standard used by your TV model. Carefully attach the wall mount bracket at the rear of the TV. Install the wall mount bracket on a solid wall perpendicular to the floor. If you are attaching the TV to other building materials, please contact qualified personnel to install the wall mount. Detailed instructions will be included with the wall mount. We recommend that you use an LG brand wall mount. The LG wall mount is easy to adjust or to connect the cables. When you do not use LG's wall mount bracket, use a wall mount bracket where the device is adequately secured to the wall with enough space to allow connectivity to external devices. If you are using a non-adjustable mount, attach the mount to the wall. Attach the cables to the TV first, then attach the TV to the mount.



- Remove the stand before installing the TV on a wall mount by performing the stand attachment in reverse.
- For more information of screws and wall mount bracket, refer to the Separate Purchase.
- If you intend to mount the product to a wall, attach VESA standard mounting interface (optional parts) to the back of the product. When you install the set to use the wall mounting bracket (optional parts), fix it carefully so as not to drop.
- When mounting a TV on the wall, make sure not to install the TV by hanging the power and signal cables on the back of the TV.
- Do not install this product on a wall if it could be exposed to oil or oil mist. This may damage the product and cause it to fall.
- Please use the accessory cable holder when hanging on the wall. (Only OLED48/83C2*)

Antenna/Cable

Connect an antenna, cable, or cable box to watch TV while referring to the following. The illustrations may differ from the actual items and an RF cable is optional.

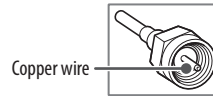

- Make sure not to bend the copper wire of the RF cable.
- Complete all connections between devices, and then connect the power cord to the power outlet to prevent damage to your TV.
- Use a signal splitter to use 2 TVs or more.
- DTV Audio Supported Codec: MPEG, Dolby Digital
- This TV cannot receive Ultra HD (3840 x 2160 pixels) broadcasts directly because the related standards have not been confirmed (Depending upon country).
- Use the AV cover for aesthetic purposes. Connecting too many cables may cause lifting problems. In such a case, remove the AV cover before use (Depending upon model).

Starting TV

Turning on the TV

You can simply operate the TV functions, using the button.

<A type>



Power On (Press)
Power Off¹⁾ (Press and Hold)
Menu Control (Press²⁾)
Menu Selection (Press and Hold³⁾)

- 1) All running apps will close.
- 2) You can access and adjust the menu by pressing the button when TV is on.
- 3) You can use the function when you access menu control.

<B type>



Power On (Press)
Power Off¹⁾ (Press and hold)



Volume Control



Channels Control

- 1) All running apps will close.

✔ Note

- When the TV is turned on for the first time after being shipped from the factory, initialization of the TV may take approximately one minute..

- The cables mentioned in this guide is not supplied with your unit.

- Accessory type and quantity may vary depending on the model.

- The image shown here is for illustrative purposes only and may be subject to change.

Connections

You can connect various external devices to the TV. For more information on external device's connection, refer to the manual provided with each device.

HDMI

- When connecting the HDMI cable, the product and external devices should be turned off and unplugged.
- Supported HDMI Audio format (Depending upon model):
True HD (48 kHz),
Dolby Digital / Dolby Digital Plus (32 kHz / 44.1 kHz / 48 kHz),
PCM (32 kHz / 44.1 kHz / 48 kHz / 96 kHz / 192 kHz)

✔ Note

- If the device connected to Input Port also supports HDMI Deep Color, your picture may be clearer. However, if the device doesn't support it, it may not work properly. In that case, change the TV's [HDMI Deep Color] setting to off.
-  → [General] → [Devices] → [HDMI Settings] → [HDMI Deep Color]
- Use a certified cable with the HDMI logo attached. If you do not use a certified HDMI cable, the screen may not display or a connection error may occur.
- Recommended HDMI cable types (3 m (9.84 feet) or less)
 - Ultra High Speed HDMI®/™ cable

USB

Some USB Hubs may not work. If a USB device connected through a USB Hub is not detected, connect it directly to the USB port on the TV.

✔ Note

- For an optimal connection, HDMI cables and USB devices should have bezels less than 10 mm (0.39 inches) thick and 18 mm (0.7 inches) width.
- Use an extension cable that supports USB 2.0 if the USB cable or USB flash drive does not fit into your TV's USB port.

IR Blaster

Control the set-top box (cable/satellite/IP/OTT), Blu-ray/DVD player, soundbar, game consoles, etc., using the IR Blaster. (Depending upon country) (Depending upon models)

- Connect the IR Blaster cable to the TV's IR Blaster port.
- Use universal control settings to control the device.
- Secure the IR Blaster with the 3M tape provided.

External Devices

Supported external devices are: Blu-ray player, HD receivers, DVD players, VCRs, audio systems, USB storage devices, PC, gaming devices, and other external devices.

✔ Note

- The external device connections shown may differ slightly from illustrations in a manual.
- In PC mode, there may be noise associated with the resolution, vertical pattern, contrast or brightness. If noise is present, change the PC output to another resolution, change the refresh rate to another rate or adjust the brightness and contrast on the [Picture] menu until the picture is clear. Depending upon the graphics card, some resolution settings may not allow the image to be positioned on the screen properly.
- When connecting to a wired LAN, use a CAT 7 cable with high-speed Internet transmission.
- The TV may be capable of operating without a set-top-box from a multichannel video programming distributor (MVPD).

Remote RS-232C setup

To obtain the RS-232C external control setup information, please visit www.lg.com. Download and read the manual, (Depending upon model).



- Do not drop the product or let it fall over when connecting external devices. Otherwise, this may result in injury or damage to the product.
- When connecting external devices such as video game consoles, make sure the connecting cables are long enough. Otherwise, the product may fall over, which may cause injury or damage the product.

Specifications

Product specifications may be changed without prior notice due to upgrade of product functions.

Estimated yearly energy consumption indicated on the FTC label is measured in accordance with the Test Procedures for Television Sets (USA only).

The actual energy consumption depends on the usage environment (The content watched, TV settings, etc.).

- For information of the power supply and power consumption, refer to the label attached to the product.
 - The typical power consumption is measured in accordance with IEC 62087 or each country's energy regulations.
 - * On some models, the label is inside the external device connection terminal cover.
 - * Depending upon the model or country, the typical power consumption may not be on label.

(Depending upon country)

Broadcasting Specifications	
Television system	ATSC / NTSC-M, 64 & 256 QAM
Channel coverage (Band)	VHF 2-13, UHF 14-69, DTV 2-69, CATV 1-135, CADTV 1-135
External antenna impedance	75 Ω

Environment Condition	
Operating Temperature	0 °C to 40 °C (32 °F to 104 °F)
Operating Humidity	Less than 80 %
Storage Temperature	-20 °C to 60 °C (-4 °F to 140 °F)
Storage Humidity	Less than 85 %

Product Information

(Only OLED42/48/55/65/77/83C2AUA)

Wireless module(LGSBWAX12)Specifications

Wireless LAN (IEEE 802.11a/b/g/n/ac/ax)

Frequency range	Output Power (Max.)
2,400 to 2,472 MHz	17 dBm
5,150 to 5,725 MHz	15 dBm
5,725 to 5,850 MHz	15 dBm
5,945 to 7,125 MHz	11 dBm

Bluetooth

Frequency range	Output Power (Max.)
2,400 to 2,483.5 MHz	9 dBm

As band channels can vary per country, the user cannot change or adjust the operating frequency. This product is configured for the regional frequency table.

For consideration of the user, this device should be installed and operated with a minimum distance of 20 cm (7.8 inches) between the device and the body.

- 1) FCC regulations restrict the operation of this device to indoor use only.
- 2) Operation prohibited on oil platforms, cars, trains, boats, and aircraft, except that operation of this device is permitted in large aircraft while flying above 10,000 feet.

FCC ID: BEJLGSBWAX12 / IC: 2703H-LGSBWAX12

(Except for OLED42/48/55/65/77/83C2AUA)

Wireless module(LGSBWAC95)Specifications

Wireless LAN (IEEE 802.11a/b/g/n/ac)

Frequency range	Output Power (Max.)
2,400 to 2,483.5 MHz	18.5 dBm
5,150 to 5,725 MHz	18 dBm
5,725 to 5,850 MHz	18 dBm

Bluetooth

Frequency range	Output Power (Max.)
2,400 to 2,483.5 MHz	9 dBm

As band channels can vary per country, the user cannot change or adjust the operating frequency. This product is configured for the regional frequency table.

For consideration of the user, this device should be installed and operated with a minimum distance of 20 cm (7.8 inches) between the device and the body.

FCC ID: BEJLGSBWAC95 / IC: 2703H-LGSBWAC95

Open Source Software Notice Information

To obtain the source code that is contained in this product, under GPL, LGPL, MPL, and other open source licenses that have the obligation to disclose source code, and to access all referred license terms, copyright notices and other relevant documents please visit <https://opensource.lge.com>.

Licenses

HDMI™

HIGH-DEFINITION MULTIMEDIA INTERFACE

QUICK SET®

(Magic Remote supported models only)

HE Advance™

Covered by patents at patentlist.accessadvance.com

Troubleshooting

In TV / HDMI input, press the  button on the remote control three times to display the model name and serial number on the screen.

Cannot control the TV with the remote control.	<ul style="list-style-type: none">• Check if anything such as tape has been placed over the receiver.• Check if there is any obstacle between the product and the remote control.• Replace the batteries with new fresh ones.
No image display and no sound is produced.	<ul style="list-style-type: none">• Check if the product is turned on.• Check if the power cord is connected to a wall outlet.• Check if there is a problem in the wall outlet by connecting other products.
The TV turns off suddenly.	<ul style="list-style-type: none">• Check the power control settings. The power supply may be interrupted.• Check if the auto-off function is activated in the settings menu.• If there is no signal while the TV is on, the TV will turn off automatically after 15 minutes of inactivity.
Abnormal Display	<ul style="list-style-type: none">• If the TV feels cold to the touch, there may be a small flicker when it is turned on. This is normal; there is nothing wrong with TV. Some minute dot defects may be visible on the screen, appearing as tiny red, green, or blue spots. However, they have no adverse effect on the TV's performance. Avoid touching the screen or holding your finger(s) against it for long periods of time. Doing so may produce some temporary distortion effects on the screen.• This panel is an advanced product that contains millions of pixels. In a very few cases, you could see fine dots on the screen while you're viewing the TV. Those dots are deactivated pixels and do not affect the performance and reliability of the TV.
Generated Sound	<ul style="list-style-type: none">• Cracking noise A cracking noise that occurs when watching or turning off the TV is generated by plastic thermal contraction due to temperature and humidity. This noise is common for products where thermal deformation is required.• Electrical circuit humming/panel buzzing A low level noise is generated from a high-speed switching circuit, which supplies a large amount of current to operate a product. It varies depending upon the product. This generated sound does not affect the performance and reliability of the product.



- Make sure to wring any excess water or cleaner from the cloth.
- Do not spray water or cleaner directly onto the TV screen.
- Make sure to spray just enough of water or cleaner onto a dry cloth to wipe the screen.

Precautions for Protecting the OLED TV Screen

Unlike regular LED/LCDs, OLED TVs produce images that emit light for each pixel, achieving a perfect black color and delivering clear images without blurring.

Due to the nature of the organic materials used to achieve high-resolution image quality, OLED displays generally experience image retention on the screen, which can be a persistent phenomenon. This phenomenon is observed in all OLED panels, and although recommended picture modes can minimize image retention, current technology cannot completely prevent this from occurring.



Displaying the same image for a long time or repeatedly displaying the same image can cause image retention on the screen, which is a common phenomenon in OLED panel products due to the nature of the product. This product has a built-in screen protection feature. Avoid displaying images that are likely to cause image retention, and follow the recommendations.

Images that are likely to cause image retention







- Images with black areas on the top and bottom and/or the left and right sides of the screen.
- Images whose aspect ratio is 4:3 or 21:9.
- Images that are fixed for a long time, such as channel number, station logo, game console icon, set-top box menu, etc.
- Other fixed screen images or repeatedly displayed images.



Running [Pixel Cleaning] to Protect the OLED TV Screen

The OLED TV is equipped with a pixel cleaning feature to check the status of the screen by itself and prevent image retention. This feature is automatically calculates the optimal execution time based on the accumulated viewing time and is automatically executed when the TV is turned off. While this feature is running, horizontal lines may appear at the top and bottom of the screen. The pixel cleaning feature works when the product is connected to the power cord and main power.

- To run this function manually, press the  /  button on the remote control, go to  → [General] → [OLED Care] → [OLED Panel Care] and press [Pixel Cleaning].

Recommendations for Minimizing Image Retention

When watching the TV for a long time, press the  /  button on the remote control, go to  → [Picture] → [Select Mode] and set the mode to [APS], go to [Advanced Settings] → [Brightness] and set [OLED Pixel Brightness] to a lower level. In addition, press the  /  button on the remote control, go to  → [General] → [OLED Care] → [OLED Panel Care] and set the [Adjust Logo Brightness] value to [High].

When showing images with black bars at the top/bottom/left/right side of the screen, press the  /  button on the remote control, press  and go to [Picture] → [Aspect Ratio] → [User Selection] → [Vertical Zoom] or [4-Way Zoom] to remove the black bars.

Turn off the menus for setting up devices such as set-top boxes so that they are not displayed on the screen for a long time.

Note

- When the screen is showing one fixed image for a long time, the screen brightness will be automatically reduced and then restored once the screen content changes. This is a normal function to minimise image retention.

Regulatory

FCC NOTICE

(For USA)

This equipment has been tested and found to comply with the limits for a Class B digital device, pursuant to Part 15 of the FCC Rules. These limits are designed to provide reasonable protection against harmful interference in a residential installation. This equipment generates, uses, and can radiate radio frequency energy and, if not installed and used in accordance with the instructions, may cause harmful interference to radio communications. However, there is no guarantee that interference will not occur in a particular installation. If this equipment does cause harmful interference to radio or television reception, which can be determined by turning the equipment off and on, the user is encouraged to try to correct the interference by one or more of the following measures:

- Reorient or relocate the receiving antenna.
- Increase the separation between the equipment and the receiver.
- Connect the equipment to an outlet on a circuit different from that to which the receiver is connected.
- Consult the dealer or an experienced radio/TV technician for help.

This device complies with part 15 of the FCC Rules. Operation is subject to the following two conditions: (1) this device may not cause harmful interference and (2) this device must accept any interference received, including interference that may cause undesired operation. Any changes or modifications in construction of this device which are not expressly approved by the party responsible for compliance could void the user's authority to operate the equipment and For indoor use only, use outdoors or in other modes not covered by this manual may violate the FCC regulation and violate the user authority to use the product.

FCC Radio Frequency Interference Requirements (for UNII devices)

(For USA)

High power radars are allocated as primary users of the 5.25 to 5.35 GHz and 5.65 to 5.85 GHz bands. These radar stations can cause interference with and/or damage this device. This device cannot be co-located with any other transmitter.

FCC RF Radiation Exposure Statement

(For USA)

(For having wireless function (WLAN, Bluetooth,...))

This equipment complies with FCC radiation exposure limits set forth for an uncontrolled environment. This transmitter must not be co-located or operating in conjunction with any other antenna or transmitter. This equipment should be installed and operated with minimum distance 20 cm (7.8 inches) between the antenna and your body. Users must follow the specific operating instructions for satisfying RF exposure compliance.

Industry Canada Statement

(For Canada)

(For having wireless function (WLAN, Bluetooth,...))

This device contains licence-exempt transmitter(s)/receiver(s) that comply with Innovation, Science and Economic Development Canada's licence-exempt RSS(s). Operation is subject to the following two conditions:

- (1) This device may not cause interference.
- (2) This device must accept any interference, including interference that may cause undesired operation of the device.

IC Radiation Exposure Statement

(For Canada)

(For having wireless function (WLAN, Bluetooth,...))

This equipment complies with IC radiation exposure limits set forth for an uncontrolled environment. This equipment should be installed and operated with minimum distance 20 cm (7.8 inches) between the antenna & your body.

NOTE: THE MANUFACTURER IS NOT RESPONSIBLE FOR ANY RADIO OR TV INTERFERENCE CAUSED BY UNAUTHORIZED MODIFICATIONS TO THIS EQUIPMENT. SUCH MODIFICATIONS COULD VOID THE USER'S AUTHORITY TO OPERATE THE EQUIPMENT.

RSS-247 Requirement

(For Canada)

(For product having the wireless function using 5 GHz frequency bands)

- (1) The device for operation in the band 5150–5250 MHz is only for indoor use to reduce the potential for harmful interference to co-channel mobile satellite systems;
- (2) For devices with detachable antenna(s), the maximum antenna gain permitted for devices in the bands 5250-5350 MHz and 5470-5725 MHz shall be such that the equipment still complies with the e.i.r.p. limit;
- (3) For devices with detachable antenna(s), the maximum antenna gain permitted for devices in the band 5725-5850 MHz shall be such that the equipment still complies with the e.i.r.p. limits as appropriate; and
- (4) (For devices operating in the band 5250-5350 MHz having an e.i.r.p. greater than 200 mW) Antenna type(s), antenna models(s), and worst-case tilt angle(s) necessary to remain compliant with the e.i.r.p. elevation mask requirement set forth in section 6.2.2.3 of RSS-247 shall be clearly indicated.

Users should also be advised that high-power radars are allocated as primary users (i.e. priority users) of the bands 5250-5350 MHz and 5650-5850 MHz and that these radars could cause interference and/or damage to LE-LAN devices.

NOTE TO CABLE/TV INSTALLER

(For USA and Canada)

This reminder is provided to call the CATV system installer's attention to Article 820-40 of the National Electric Code (U.S.A.). The code provides guidelines for proper grounding and, in particular, specifies that the cable ground shall be connected to the grounding system of the building, as close to the point of the cable entry as practical.

WARNING! (STABILITY HAZARD)

A television set may fall, causing serious personal injury or death. Many injuries, particularly to children, can be avoided by taking simple precautions such as:

- ALWAYS use cabinets or stands or mounting methods recommended by the manufacturer of the television set.
- ALWAYS use furniture that can safely support the television set.
- ALWAYS ensure the television set is not overhanging the edge of the supporting furniture.
- ALWAYS educate children about the dangers of climbing on furniture to reach the television set or its controls.
- ALWAYS route cords and cables connected to your television so they cannot be tripped over, pulled or grabbed.
- NEVER place a television set in an unstable location.
- NEVER place the television set on tall furniture (for example, cupboards or bookcases) without anchoring both the furniture and the television set to a suitable support.
- NEVER place the television set on cloth or other materials that may be located between the television set and supporting furniture.
- NEVER place items that might tempt children to climb, such as toys and remote controls, on the top of the television or furniture on which the television is placed.

If the existing television set is going to be retained and relocated, the same considerations as above should be applied.

Symbols

	Refers to alternating current (AC).		Refers to stand-by.
	Refers to direct current (DC).		Refers to "ON" (power).
	Refers to class II equipment.		Refers to dangerous voltage.

LG Take-back & Recycling Policy

(For USA)

LG Electronics offers a customized e-waste take-back & recycling service that meets local needs and requirements in the countries where e-waste regulations are in place, and also provides product take-back & recycling service voluntarily in some regions. LG Electronics evaluates products' recyclability at the design step selectively, with the goal of improving recyclability where practicable. Through these activities, LG Electronics seeks to contribute to conserving natural resources and protecting the environment. For more information, please visit our global site at <https://www.lg.com/recycling>

THE CONSUMER TECHNOLOGY INDUSTRY CARES

Manufacturers, retailers and the rest of the consumer technology industry are committed to making products safe and enjoyable. As you enjoy your television, please note that all televisions – new and old- must be supported on proper stands or installed according to the manufacturer's recommendations. Televisions that are inappropriately situated on dressers, bookcases, shelves, desks, speakers, chests, carts, etc., may fall over, resulting in injury.



TUNE IN TO SAFETY

- **NEVER** allow children to climb on or play on the television or the furniture on which the television is placed.
- **NEVER** place the television on furniture that can easily be used as steps, such as a chest of drawers.
- **ALWAYS** follow the manufacturer's recommendations for the safe installation of your television.
- **ALWAYS** read and follow all instructions for proper use of your television.
- **ALWAYS** install the television where it cannot be pushed, pulled over or knocked down.
- **ALWAYS** route cords and cables connected to the television so that they cannot be tripped over, pulled or grabbed.



WALL OR CEILING MOUNT YOUR TELEVISION

- **ALWAYS** contact your retailer about professional installation if you have any doubts about your ability to safely mount your television.
- **ALWAYS** use a mount that has been recommended by the television manufacturer and has a safety certification by a Nationally Recognized Testing Laboratory (NRTL).
- **ALWAYS** follow all instructions supplied by the television and mount manufacturers.
- **ALWAYS** make sure that the wall or ceiling where you are mounting the television is appropriate. Use proper anchoring systems for different wall or ceiling types (e.g. wood, concrete, metal, etc.). If you are unsure, contact a professional installer.
- Televisions can be heavy. A minimum of two people is required for a wall or ceiling mount installation.



MOVING AN OLDER TELEVISION TO A NEW PLACE IN YOUR HOME

- **REMEMBER** Special care should be made in the placement of older CRT/flat-panel televisions. Many new television buyers move their older CRT/flat-panel televisions into a secondary room after the purchase of a flat-panel television.
- **NEVER** place your older CRT/flat-panel television on a dresser where children may be tempted to use the drawers to climb.
- **ALWAYS** place your older CRT/flat-panel television on furniture that is sturdy and appropriate for its size and weight.
- **ALWAYS** make sure your older CRT/flat-panel television does not hang over the edge of your furniture.

Power Turns the TV on or off.

GUIDE Accesses the [Guide].

— **(Dash)** Inserts a — between numbers such as 2-1 and 2-2.

Accesses the saved channel list.



Accesses the [Edit Quick Access].

- [Edit Quick Access] is a feature that allows you to enter a specified app or Live TV directly by pressing and holding the number buttons.

Volume buttons Adjusts the volume level.

Home Accesses the Home menu.

Home Launches the last used apps.

Wheel (OK) Press the center of  button to select a menu. You can change channels by using  button.

Wheel (OK) Accesses the [Magic Explorer]. You can run the [Magic Explorer] feature when the pointer color is changed to purple. If watching a channel, press and hold down the pointer onto the video. When using [TV Guide], [Settings], [Sports Alert], or [Art Gallery], press and hold down on the text.

Up/Down/Left/Right Press the up, down, left or right button to scroll the menu. If you press  buttons while the pointer is in use, the pointer will disappear from the screen and Magic Remote will operate like a general remote control. To display the pointer on the screen again, shake Magic Remote to the left and right.

Back Returns to the previous level.

Back Clears on-screen displays and returns to last input viewing.

Microphone

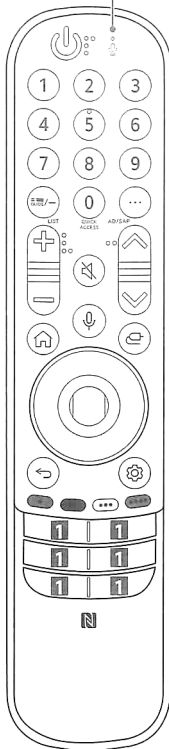

 **



AD/SAP**



























Number buttons Enters numbers.

Accesses the [Quick Help].

More actions Displays more remote control functions.

SAP (Secondary Audio Program) feature can also be enabled by pressing the  button.

Channel buttons Scrolls through the saved channels.

Mute Mutes all sounds.

Mute Accesses the [Accessibility] menu.

Voice recognition Network connection is required to use the voice recognition function.

Check for recommended content. (Some recommended services may not be available in some countries.)

Voice recognition Speak while pressing and holding the button to use the voice recognition feature.

Input Changes the input source.

Input Accesses the [Home Dashboard].

Q. Settings Accesses the Quick Settings.

Q. Settings Displays the [All Settings] menu.

These access special functions in some menus.

Red button Runs the record function.

Streaming Service buttons Connects to the Video Streaming Service.

**** To use the button, press and hold for more than 1 second.**

(Batteries not included)

The descriptions in this manual are based on the buttons on the remote control. Please read this manual carefully and use the TV correctly.

This remote uses infrared light. When in use, it should be pointed in the direction of the TV's remote sensor.

(Some buttons and services may not be provided depending upon models or regions.)



How to register the Magic Remote Control



To use the Magic Remote, first pair it with your TV.

- 1 Put batteries into the Magic Remote and turn the TV on.
- 2 Point the Magic Remote at your TV and press the  **Wheel (OK)** on the remote control.

* If the TV fails to register the Magic Remote, try again after turning the TV off and back on.

How to deregister the Magic Remote Control

Press the  (**Back**) and  (**Home**) buttons at the same time, for five seconds, to unpair the Magic Remote with your TV.

* Press and hold the  (**Home**) and  (**Q. Settings**) buttons for more than 5 seconds to disconnect and re-register the Magic Remote at the same time.







- It is recommended that an Access Point (AP) be located more than 0.2 m (0.65 ft) away from the TV. If the AP is installed closer than 0.2 m (0.65 ft), the Magic remote control may not perform as expected due to frequency interference.



Using Always Ready



(Depending upon model)

You can operate the TV and connect to Bluetooth with direct voice recognition while the power is off.



*  →  → [General] → [Always Ready], setting [Enable the function] to on.

* Pressing the  button while watching TV switches the screen to [Always Ready] that is turned on, and pressing the  button once more turns the screen to [Always Ready] that is turned off.

* Press the  (**Home**) button or the  (**Back**) button to watch TV when the screen is in [Always Ready] that is turned on.

* Press the  **Wheel (OK)** button to display the wallpaper when the screen is in [Always Ready] that is turned off, and press the  button to watch TV.

✔ Note

- Using Always Ready may increase energy consumption.
- For models with motion sensors, such as G2, if you set screen on with the motion sensor, the TV will turn on by recognising the motion.
- For more information about the feature, refer to the  →  → [Support] → [User Guide] → [Troubleshooting] → [Learn More About Always Ready].

Connecting Smart Devices using NFC Tagging

NFC is technology that uses Near Field Communication (13.56 MHz), allowing you to conveniently send and receive information without separate settings. By bringing a smart device near the NFC-enabled remote control, you can install the LG ThinQ app and connect the device to the TV.

- 1 Turn on NFC in the smart device's settings. To use NFC with Android devices, set the NFC option to enable 'read/write tags' in the smart device's settings. The NFC settings may vary depending upon the device.
- 2 Bring the smart device near the  (NFC) on the remote control. The required distance for NFC tagging is about 1 cm (0.39 inches).
- 3 Follow the instructions to install the LG ThinQ app on your smart device.
- 4 Retagging the smart device to the remote control allows you to conveniently access various features on the connected TV through the LG ThinQ app.

✔ Note

- This feature is available for NFC-enabled smart devices only.
- This feature is only available if the remote control has an NFC logo.

Specifications

Specifications (MR22GN, MR22GA)		
	Frequency range	Output Power (Max.)
Bluetooth	2,400 to 2,483.5 MHz	7 dBm
NFC	13.56 MHz	-

* Only MR22GN

- The remote control vary depend of model: The buttons on the remote control may have a different name or location than the remote control shows in this manual.

814100128



PRINTED IN MEXICO / SC: 08-16-2023

Elbrd: J.E. / Shnmdl: OLED77A2AUA

Obpn: *MFL718561322211REV05*

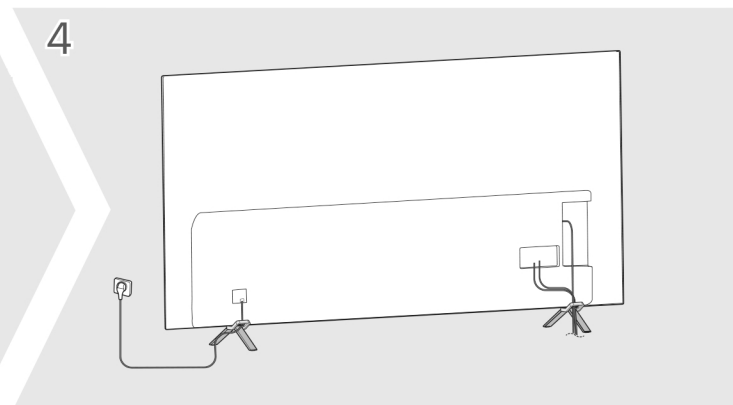
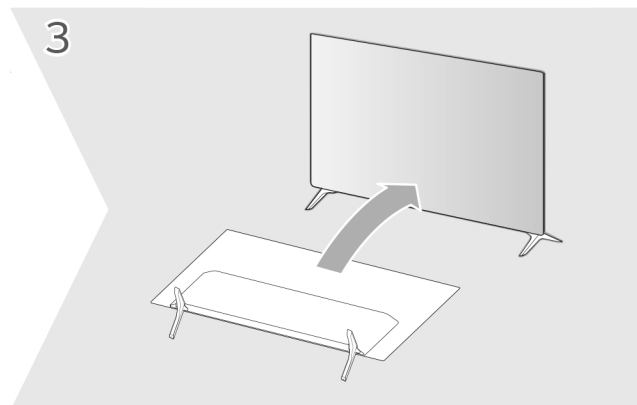
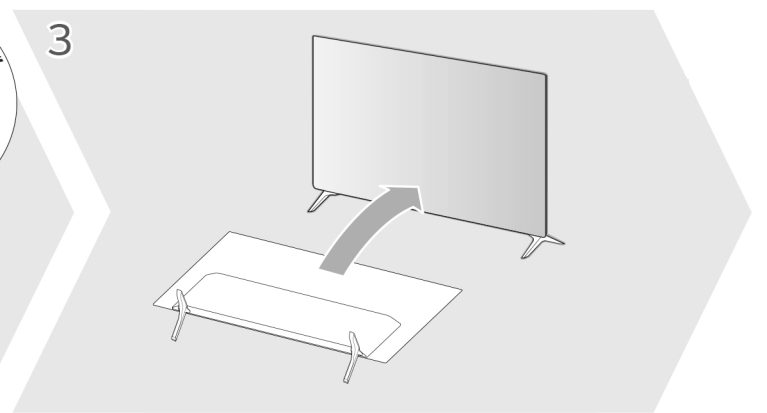
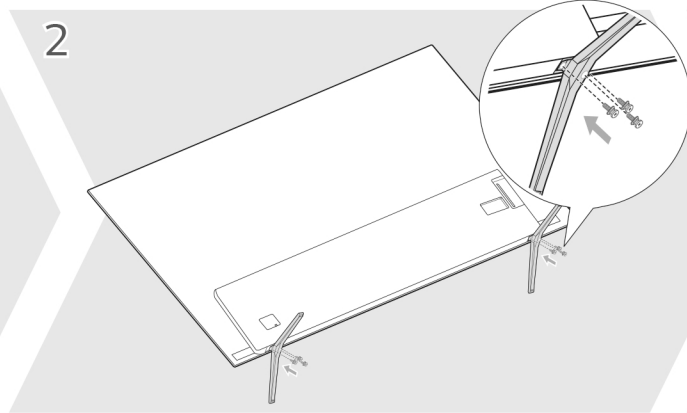
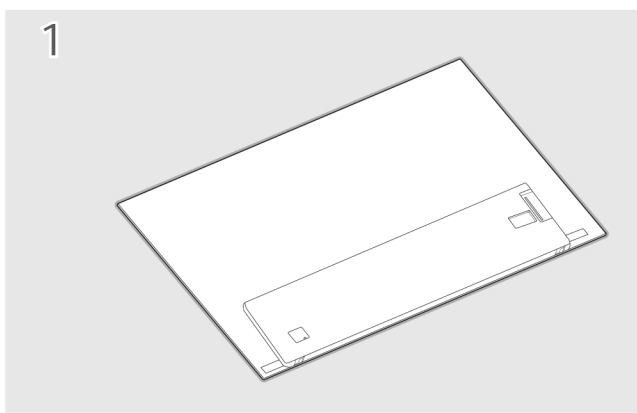
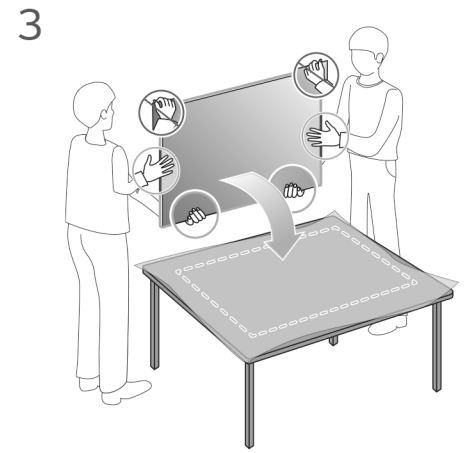
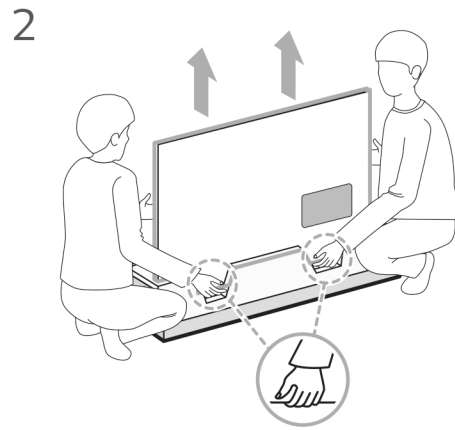
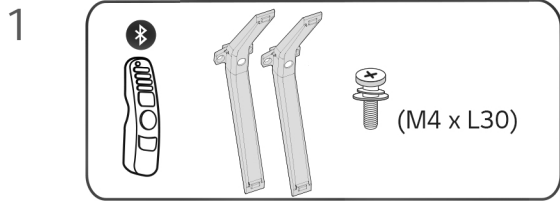
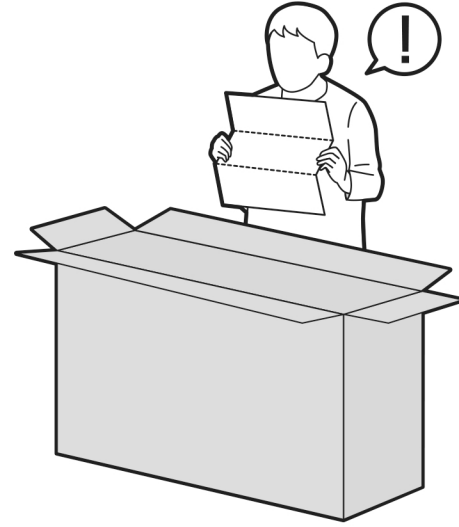
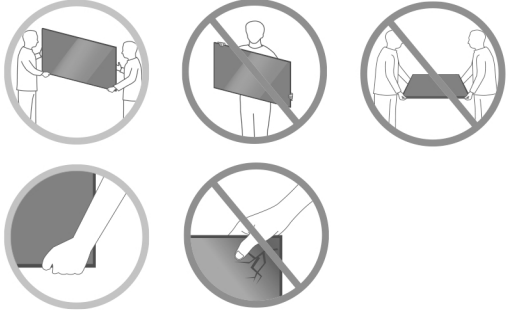

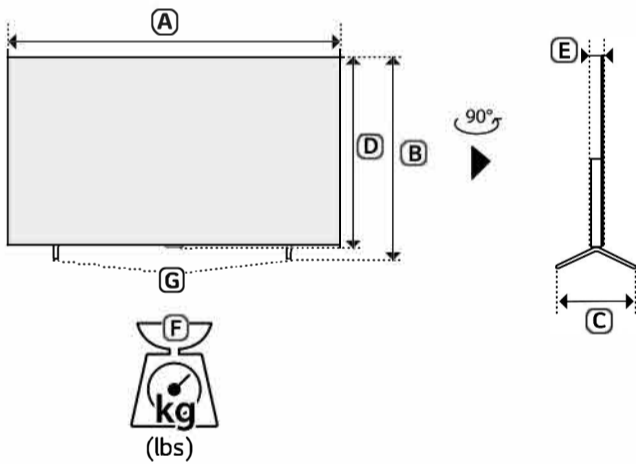
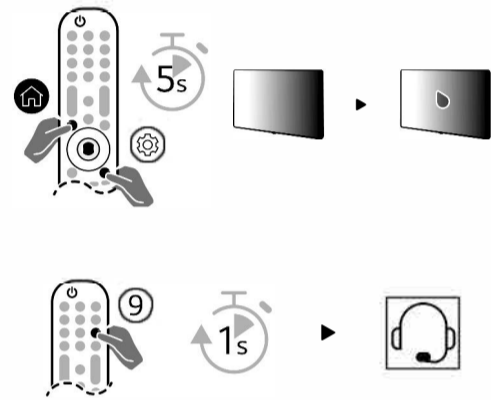
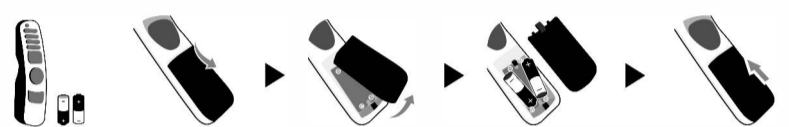
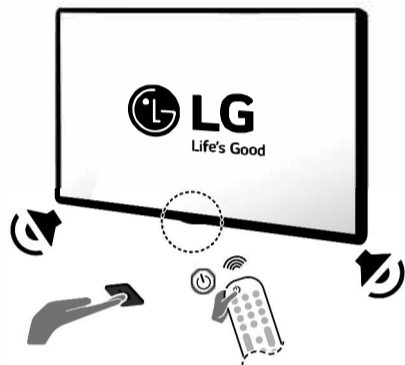
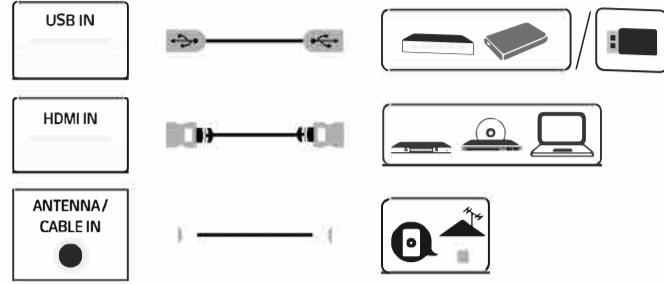
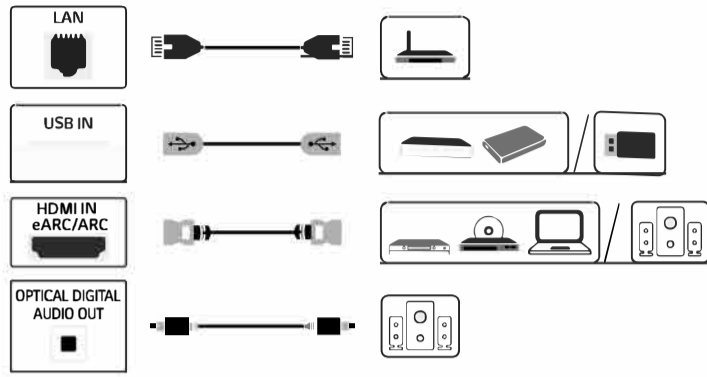

A, B, C, D, E: mm (inches)
F, G: kg (lbs)

MODELS	A		B		C		D		E		F		F-G		Power consumption
OLED77A2AUA	1,719	1,719	1,057	1,057	319	319	989	989	50,9	50,9	23,5	23,5	22,9	22,9	510 W
OLED77A2PUA	(67,6)	(67,6)	(41,6)	(41,6)	(12,5)	(12,5)	(38,9)	(38,9)	(2,0)	(2,0)	(51,8)	(51,8)	(50,4)	(50,4)	
Power requirement										AC 120 V~ 50/60 Hz					

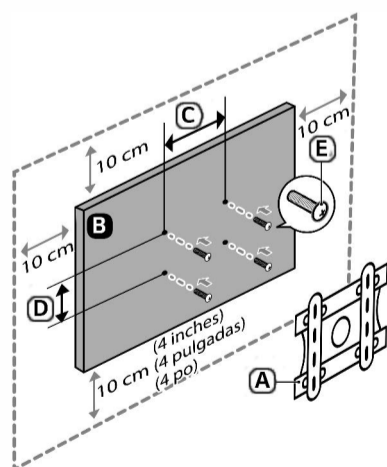

C, D: mm (inches)

A	B	C x D (mm)	E
OLW480B	OLED77A2*	300 (11,8) x 200 (7,8)	M6
		300 (11,8) x 200 (7,8)	



Read **Safety and Reference**.
Easy Setup Guide
Please read this manual carefully before operating your set and retain it for future reference.

⊕ : Depending upon model

814000128



PRINTED IN MEXICO / SC: 08-16-2023 / Pags: 2P / Elbrd: J.E.
Shmmdl: OLED77A2PUA_B
Obpn: *MFL718785252208REV00*