

Please read this manual carefully before operating your unit and retain for future reference.

SAFETY INFORMATION

WARNING For your safety, the information in this manual must be followed to minimize the risk of fire, electric shock or personal injury.

- Use this appliance only for its intended purpose as described in this Owner's Manual.
- This air conditioner must be properly installed in accordance with the Installation Instructions before it is used.
- Never unplug your air conditioner by pulling on the power cord. Always grip plug firmly and pull straight out from the receptacle.
- Replace immediately all electric service cords that have become frayed or otherwise damaged. A damaged power supply cord must be replaced with a new power supply cord obtained from the manufacturer and not repaired. Do not use a cord that shows cracks or abrasion damage along its length or at either the plug or connector end.
- Turn the unit OFF and unplug your air conditioner before cleaning.
- For your safety...do not store or use combustible materials, gasoline or other flammable vapors or liquids in the vicinity of this or any other appliance.
- If the receptacle does not match the plug, the receptacle must be changed out by a qualified electrician.

Controls

Features and appearance will vary. Lights next to the touch pads on the air conditioner control panel indicate the selected settings.

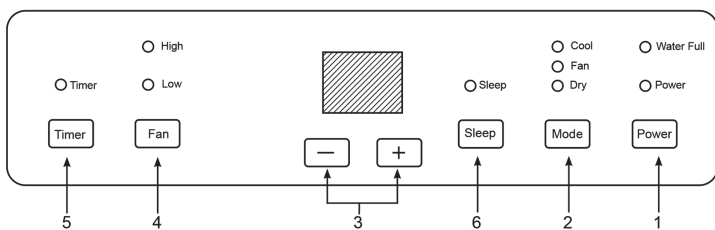

NOTE: When the machine is powered on for the first time, the buzzer will play power-on music and then the machine will go into standby status.

1. Power Button

Turns ON/OFF power to the air conditioner.
NOTE: Turning off power by pressing the **Power** button does NOT disconnect the appliance from power supply. Press the **Power** button. The Power indicator will illuminate.

2. Mode Button

Press the **Mode** button to toggle among the operating options. The corresponding indicator will illuminate:
Cool – Cools the room to the set temperature
DRY – Reduces the humidity in the room
Fan – Circulates the air in the room without cooling

3. + and – Buttons

Sets the Temperature when in Cooling Mode or sets the Time when Timer is selected.

To Set the Temperature:

Press the + or – button to select the required temperature.

NOTE: The temperature cannot be set when the air conditioner is in either Fan or DRY mode.

To Set the Time:

Press the + or – button to select the required time.

4. Fan Speed Button

The fan speed can be adjusted from Low to High speed when the air conditioner is in operation.
NOTE: The fan speed cannot be adjusted when the unit is in DRY mode.

5. Timer Button

Program a time from (1 hour to 24 hours) for the air conditioner to turn Off or On.

6. Sleep Mode

Press the **Sleep** button to turn on Sleep Mode.
NOTE: You cannot turn on the Sleep mode in the Dry or Fan Mode.
NOTE: When the inner unit chassis is full of water, the Water Full light will turn on. A buzzer will sound for several seconds and the compressor will stop.

The image shown here is for illustrative purposes only and may be subject to change. The actual descriptions of control panel and their locations may vary, depending on the model.

The display will always default to show room temperature.

When the air conditioner is turned on, it will automatically start in the last mode and fan settings selected.

Frost Protection Function:

In cooling or dry mode, if the temperature of the exhaust hose is too low, the AC will automatically go into a unit protection state. When the temperature rises to a normal temperature, the unit will automatically resume normal operation.

Overflow Protection Function:

When water in the water pan exceeds the warning level, the machine will automatically sound an alarm, the FULL indicator light will flash and the unit will shut down. At this point, you need to drain the water from the lower drain (See Drainage instructions for details). After the water is emptied, the machine will automatically resume normal operation.

Automatic Defrosting (on some models)

The machine has an automatic defrosting function.

Protection Function of the Compressor

To increase the service life of the compressor, the AC has a 3-minute delay after the compressor has shut off to protect the compressor.

Drainage Instructions

Draining the unit manually:

Note: Please move the AC carefully, do not spill the water in the water pan at the bottom of the unit.

1. When the AC stops after the water is full, turn off the AC power and unplug the power plug.
2. Place a water container larger than the sump capacity (at least 1-1/2 quart) below the lower rear water outlet on the back side of unit.
3. Remove the plug, the water will automatically flow into the container.

Note: During drainage, the body can be tilted slightly backwards. If the water container cannot hold all the water, before the water container is full, replace the water plug as soon as possible to prevent water from flowing to the floor or the carpet.

4. After water has been drained from the unit, re-install the water plug securely.

Note: Restart the AC after the water plug is installed, otherwise condensate water from the AC will drain onto the floor or carpet.

Continuous drainage (optional, and only in dry mode)

1. Remove the upper drain plug.
2. Connect a drain hose with an inside diameter of 5/8" to the water outlet.
3. Route drain hose to a bucket or floor drain.

4. Be sure to use a large container (3 gallons or larger is recommended) and monitor the water level in the container continuously. The unit will not shut off when the container is full. An overflowing container can cause flooding and damage to the floor.

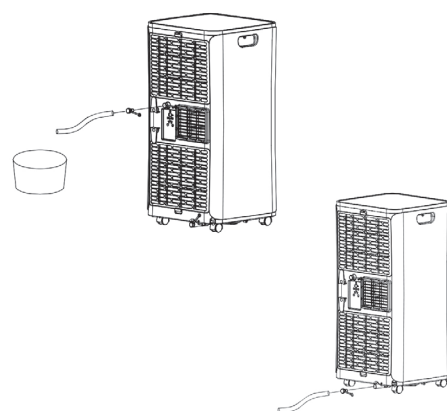

Note: The images shown here are for illustrative purpose only and may be subject to change.

Controls

Features and appearance may vary. Icons on the remote control indicate the selected settings

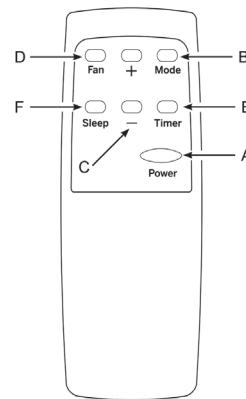

REMOTE CONTROL

1. Insert the two AAA batteries (Not supplied).
2. Aim the remote control at the signal receiver on the control panel to operate the air conditioner.

A. Power Button

Turns ON/OFF power to the air conditioner.

B. Mode Button

Press the **Mode** button to toggle among the operating options, cooling, fan and dry mode.

C. + and – Button

Adjusts the Temperature or Timing set value.

D. Fan Button

Press the **Fan** button to adjust fan speed from Low to High speed.

E. Timer

Press **Timer** button to activate the ON/OFF timer. Use the + and – buttons to adjust the timer.

F. Sleep Button

Press the **Sleep** button to turn on the sleep mode.

The remote control vary depend of model: The buttons on remote control may have a different name or location than the remote control shows in this manual.

Care and Cleaning

CLEANING

WARNING



Electrical Shock Hazard

Disconnect power before cleaning.

1. Unplug or disconnect power.
2. Use only a soft cloth dampened with water to clean the cabinet.

NOTE:

- Do not use a liquid or spray cleaner to clean the air conditioner.
- DO NOT use chemicals, abrasives, ammonia, chlorine bleach, concentrated detergents, solvents or scouring pads. Some of these chemicals/items may damage and/or discolor your air conditioner.

3. Dry thoroughly with a soft cloth.
4. Plug in or reconnect power.

Cleaning the surface

Clean surface of machine with a wet soft cloth. Do not use chemicals, such as benzene, alcohol, gasoline,

etc.; otherwise, the surface of the air conditioner will be damaged or the entire unit will be damaged.

Air Filter

The air filters should be cleaned at least every two weeks for your unit to operate at optimum efficiency.

CAUTION

DO NOT operate the air conditioner without a filter because dirt and lint will clog it and reduce performance.

To clean the upper filter screen frame:

1. Remove the upper and lower filter screens. On the top filter, place finger in recess at top of filter and pull down and outward to remove. On the lower filter, place finger in recess at bottom of filter, pull upward and outward to remove filter.

2. Remove the filter from the filter frame. It is held in place by 4 tabs. After removal, wash or vacuum the filter to remove the dirt and lint. Make sure filter is dry before reinstalling on the unit.

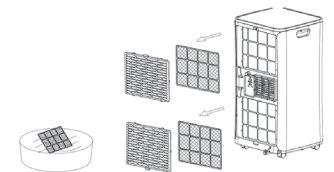

Storage

If the unit is not being used for a long period of time: To Empty the Internal Water Tank:

1. Unplug or disconnect power.
2. Drain the water from the water tank. (See "Internal Water Tank section").

3. Use the original packaging to repack the unit to avoid a buildup of dust or dirt.
4. Store the air conditioner in a cool, dry location.

Installation Instructions

BEFORE YOU BEGIN

Read these instructions completely and carefully.

- **IMPORTANT** — Save these instructions for local inspector's use.
- **IMPORTANT** — Observe all governing codes and ordinances.
- **Note to Installer** — Be sure to leave these instructions with the Consumer.
- **Note to Consumer** — Keep these instructions for future reference.
- **Skill level** — Installation of this appliance requires basic mechanical skills.
- **Completion time** — Approximately 1 hour
- We recommend two people to install this product.
- Proper installation is the responsibility of the installer.
- Product failure due to improper installation is not covered under the Warranty.
- You **MUST** use all supplied parts and use proper installation procedures as described in these instructions when installing this air conditioner.

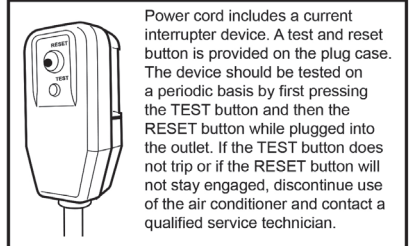

Power cord includes a current interrupter device. A test and reset button is provided on the plug case. The device should be tested on a periodic basis by first pressing the **TEST** button and then the **RESET** button while plugged into the outlet. If the **TEST** button does not trip or if the **RESET** button will not stay engaged, discontinue use of the air conditioner and contact a qualified service technician.

Location Requirements

- Place the air conditioner on a flat, level surface in a location that is at least 20" (50 cm) from any wall.
- **NOTE:** A minimum clearance of 20" (50 cm) from the air conditioner to the wall must be maintained to ensure proper airflow.
- Maintain a minimum 20" (50 cm) clearance around the air conditioner to not block airflow.
- Keep the air conditioner free of any obstructions such as drapes, curtains, blinds, etc.
- The exhaust hose should be free of any obstructions.
- Do not place the air conditioner on an unstable or raised surface because it could fall and cause damage or injury.
- Do not place the air conditioner in direct sunlight or near a heat source such as baseboard heaters, stoves, etc.
- The window panel can be installed in a window with a minimum 20" (50.8 cm) to a maximum 48" (121.9 cm) opening.

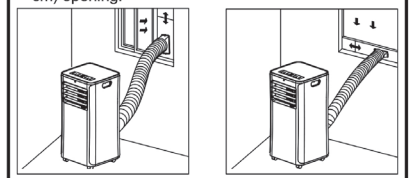

ELECTRICAL REQUIREMENTS

These models require a 115/120-volt AC, 60-Hz grounded outlet protected with a 15-amp time-delay fuse or circuit breaker.

The 3-prong grounding plug minimizes the possibility of electric shock hazard. If the wall outlet you plan to use is only a 2-prong outlet, it is your responsibility to have it replaced with a properly grounded 3-prong wall outlet.

CAUTION

Do not, under any circumstances, cut or remove the third (ground) prong from the power cord.

Do not change the plug on the power cord of this air conditioner.

Aluminium house wiring may present special problems—consult a qualified electrician.

PARTS INCLUDED

(Appearance may vary)

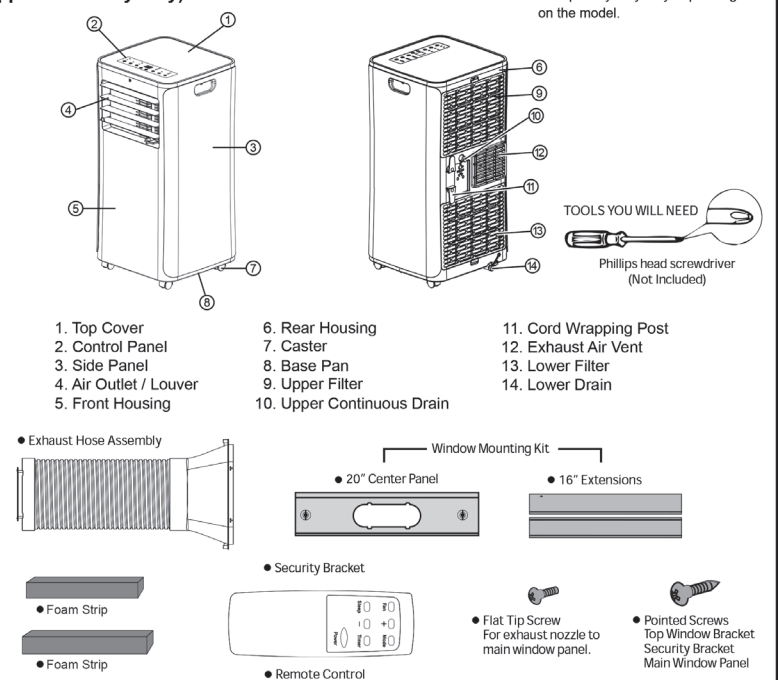

Accessory type, appearance and quantity may vary depending on the model.

TOOLS YOU WILL NEED
Phillips head screwdriver (Not included)

Installation Instructions

Window Panel Combinations to fit window openings

(Appearance may vary)

Window Opening 20"
Center Panel Only

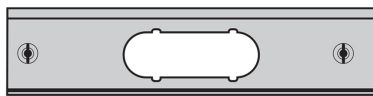

Window Opening 20"- 23½"
Center Panel + *5½" Extension

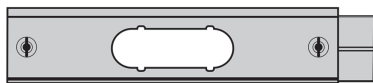

Window Opening 23½"- 27"
Center Panel + *9" Extension

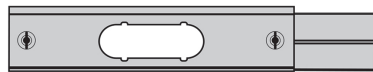

Window Opening 23½"- 30½"
Center Panel + *9" and *5½" Extensions

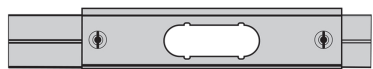

Window Opening 30½" - 34"
Center Panel + 16" Extension



Window Opening 34"- 41"
Center Panel + *9" and 16" Extensions

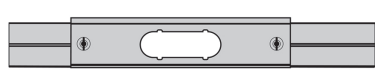

Window Opening 41"- 48"
Center Panel + (2) 16" Extensions



*NOTE: To achieve the desired measure it's necessary to cut the extension panel (16") with the tool of your choice.

1. UNPACK AIR CONDITIONER

WARNING

Excessive Weight Hazard

- Use two or more people to move and install air conditioner.
- Failure to do so can result in back or other injury.

NOTE: Before using the air conditioner, keep it upright for at least 2 hours.

- Remove packaging materials.

NOTE: There are NO packing materials inside the air conditioner to remove—Do Not open the cabinet.

- Properly dispose of/recycle all packing material.
- Handle the air conditioner gently.
- Keep the air conditioner upright and level. Do not set the air conditioner on its side, front, back or upside down.

2. Install Exhaust Nozzle to Main Window Panel

1. Hold the main window panel so that the L-shaped edges of the panel are facing you.

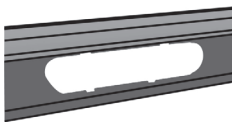

2. Align the exhaust nozzle with the slots in the opening, and then insert and slide the nozzle to access the hole from the back of the main window panel.

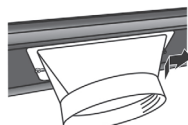

3. Turn the main window panel over, so that the nozzle is away from you. Insert a flat tip screw through the hole to fasten the window panel to the adapter.

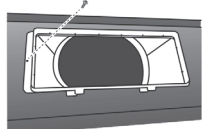

3. Install Main Window Panel and Extension Panels

NOTE: Measure the window opening and use the extension panels to fit your window.

1. Open the window and place the window kit assembly into the window.

NOTE: The window assembly is designed to accommodate either a double hung or sliding window.

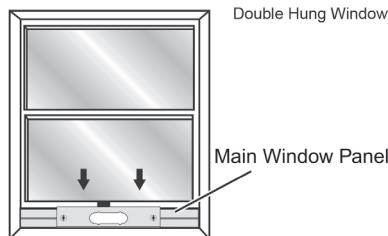

Double Hung Window

Main Window Panel

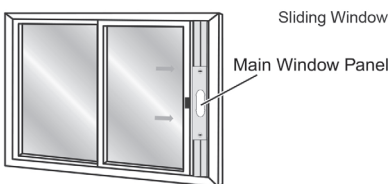

Sliding Window

Main Window Panel

2. Adjust the extension panel(s) to the width or height of the window as shown.

3. Depending on the number of extension panels used, turn the knobs to secure the extension panel(s) to the main panel. **Install from the back.**

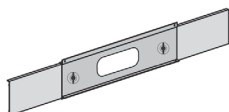

NOTE: There are many window types on the market today. Use the foam strips and brackets to secure the extension panels that will fit the window opening.

3. Install Main Window Panel and Extension Panels (cont)

4. Place the window panel assembly in the window, and using the screws provided, fasten the assembly to the window sill and window frame.

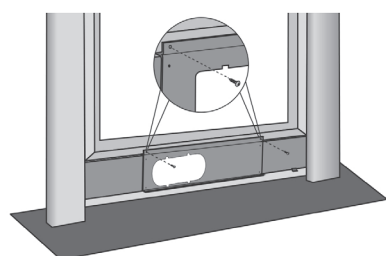

5. Using one pointed screw, install the Security bracket to the window.

NOTE: The security bracket prevents the window from being opened from the outside.

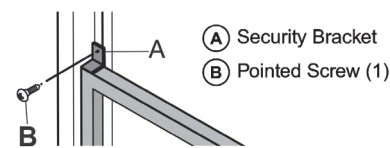

(A) Security Bracket
(B) Pointed Screw (1)

4. Attach Exhaust Hose to the Exhaust Nozzle

1. Grasp both ends of the exhaust hose and gently pull to expand the hose.
NOTE: Do not attach additional hoses to extend the length. This would decrease cooling efficiency and may damage the air conditioner.

2. Using a clockwise motion, attach the open end of the exhaust hose to the exhaust nozzle.

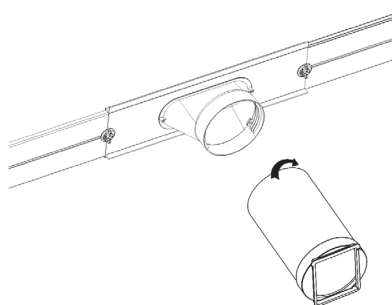

Installation Instructions

5. Connect Exhaust Hose to the Air Conditioner

NOTE: When connecting the hose, the air conditioner must be close enough to the window that you will not dislodge the window seal plate. Once the hose is connected, move the air conditioner 20" (51 cm) from the wall.

1. Extend the flexible exhaust hose to reach out to the unit.
2. Aim the opening of the hose to the air exhaust outlet and push it hard straight into the outlet until it clicks.

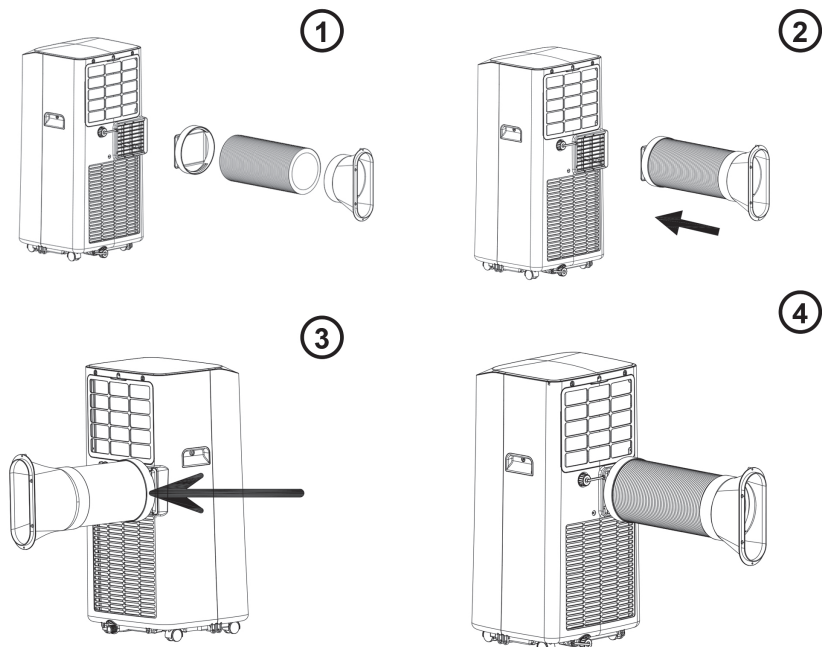

Troubleshooting Tips

Problem	Possible Causes	Solution
Unit does not start or operate	Power supply cord is not plugged into an outlet.	Plug the power cord into a grounded 3 prong outlet.
	Power supply cord has tripped.	Press and release the RESET button on the power supply cord.
	The Power button has not been pressed.	Press the Power button on the Control Panel or Remote Control to turn ON the air conditioner.
	There is no power to the electrical outlet.	Plug a working lamp into the outlet to check for power.
	A household fuse has blown or a circuit breaker has tripped.	Replace the fuse or reset the circuit breaker.
	The control was programmed for a Time Delay.	Cancel the Time Delay. See "Control Panel."
	The batteries in the remote control are dead.	Replace the batteries.
	The internal water tank is full.	Empty the water tank. See "Air Conditioner Care."
	NOTE: The air conditioner automatically turns off, and the Water Full indicator illuminates to alert you of this condition.	
Remote control is not working	Batteries are dead.	Replace the batteries.
	Batteries are installed incorrectly.	Make sure the batteries are inserted in the correct position.
Air conditioner is working but the room is not cooling.	The room temperature is hot.	Allow time for the room to cool when you first turn on the unit.
	NOTE: On extremely hot and humid days, the air conditioner will take longer to cool the room.	Make sure the air conditioner has an adequate BTU rating for the size of the room being cooled.
	The control is set incorrectly to Fan or Dehum mode.	Set the Mode to Cool and the Fan Speed to High.
	Airflow is restricted.	Remove any obstacles to the airflow and redirect airflow for uniform cooling.
	Temperature set too high.	Lower the set temperature.
	Air filters are dirty or restricted.	Clean the air filter. See "Air Conditioner Care."
	Air conditioner installed incorrectly	Check the exhaust hose and window panel for proper installation.
	Doors and windows are open.	Close the doors and windows to the room being cooled to prevent cooled air from escaping.

REFURBISHED PRODUCT LIMITED THIRTY DAY WARRANTY

The **Refurbished Product Service Center** offers the following WARRANTY to the ORIGINAL purchaser of a product which we have refurbished.

This product that has been refurbished is warranted against any electronic or mechanical defects for a period of THIRTY DAYS from the date of the original purchase by the consumer. Since this unit was sold as a refurbished item, the warranty does not apply to any cosmetic appearance items such as scratches. Should a defect occur, the **Refurbished Product Service Center** will repair or, at its option, replace defective unit/parts with new or rebuilt materials without charge for either parts or labor. Replacement unit/parts will be warranted for the remaining portion of the original warranty period.

This warranty does not cover installation or damage from accident, misuse, abuse, improper wiring, incorrect voltage, operating the unit against the instructions in the owner's manual or any product which has been opened, altered, or tampered with.

This warranty does not cover costs for removal and or installation of the unit for repair. Under no circumstances shall the service center be liable for any special, incidental or consequential damages or for any other expenses incurred by reason of use or sale of this product. This warranty is in lieu of any other warranties expressed or implied warranty of merchantability of fitness for particular use or otherwise.

This warranty gives the consumer specific legal rights and they may also have other rights which vary from State to State. Some States do not follow the exclusion or limitation of incidental or consequential damages, hence the above exclusion and limitations may not apply.

Refurbished Product Service Center
13225 Marquardt Avenue Santa Fe Springs, CA 90670

WARRANTY REPAIR INFORMATION

If you need service on your unit during the 30 day warranty period; please go to www.ConsumerServiceRefurbish.com or call the Refurbished Product Service Center at 562-946-3531 to obtain the required claim number. Once you obtain your claim number, pack the unit properly (the original carton is ideal for this purpose) along with a copy of your purchase receipt. Send the unit freight prepaid and insured to:

Refurbished Product Service Center,
Att: Customer Service Department 13225 Marquardt Avenue Santa Fe Springs, CA 90670

Your unit will be promptly exchanged and returned to you. We will refuse to accept delivery of the returned unit unless the assigned claim number appears on the outside of the shipping carton.

Owner's Information
(Keep for your permanent records)

NAME: _____
ADDRESS: _____
CITY: _____ STATE: _____ ZIP CODE: _____
PHONE: _____ E-MAIL: _____
MODEL: _____ SERIAL NO.: _____

