

Shark Rocket DELUXE PRO

Corded Ultra Light

QUICK START GUIDE

WHAT'S INSIDE

- A Handheld Vacuum
- B MultiFlex™ Wand
- C Motorized Floor Nozzle
- D Duster Crevice Tool
- E Upholstery Tool
- F Hard Floor Hero™

ASSEMBLY

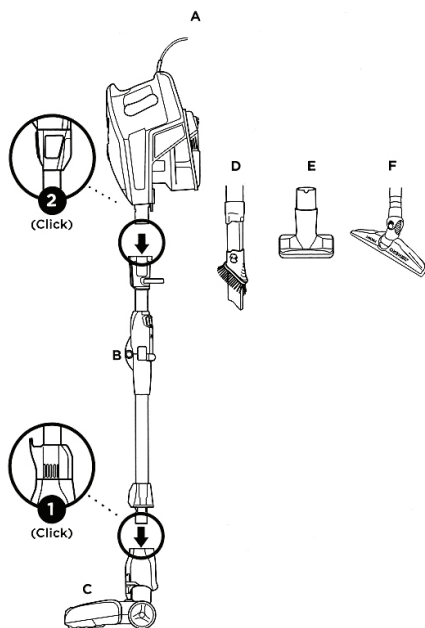

MULTIFLEX™ REACH

Easily access hard-to-reach areas under furniture. Press the MultiFLEX Lock Release button to lower the angle of the wand to increase your reach.

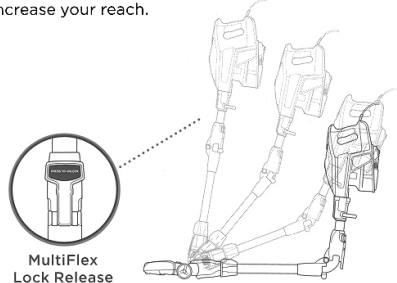

MULTIFLEX STORAGE

To store, press the Lock Release button and hold it down while folding the handheld vacuum forward, until the unit locks in storage mode. Wrap the power cord around the cord hooks, and use the handle to carry the vacuum to its storage location.

To take the vacuum out of storage mode, unwind the cord, then press the MultiFLEX Lock Release button while lifting up the handheld vacuum. The wand will lock in place.

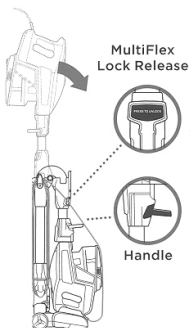

Please be sure to read the enclosed Shark® Owner's Guide prior to using your unit.

VERSATILE FLOOR-TO-CEILING CLEANING

FLOOR CLEANING

- 1 Plug In Vacuum**
Then place your foot gently on the floor nozzle and tilt the handle back.

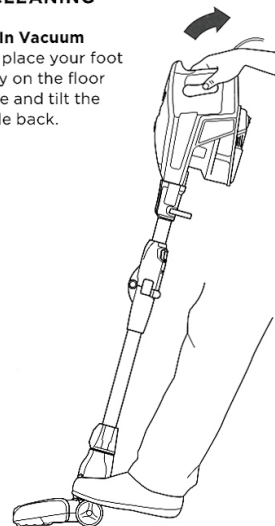

- 2 Choose Setting**
The Rocket® Deluxe Pro has a 2-speed power slider switch on the handle. Slide the power switch to the appropriate floor setting and start cleaning.

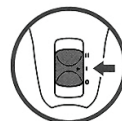

Setting I
Gentle on bare floors and delicate area rugs.
The brushroll spins slowly to clean bare floors and delicate area rugs.

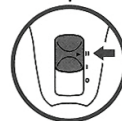

Setting II
Deep cleans carpets by removing embedded dirt.
The brushroll spins faster to pick up debris below the surface of your carpets.

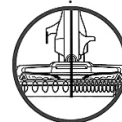

NOTE: For deep carpet cleaning per ASTM F608 (embedded dirt in carpets) please set to High Pile Carpets (II).

ABOVE-FLOOR CLEANING

- 1 Stand the vacuum upright.** Step on the foot pedal and pull the wand up to disconnect the motorized floor nozzle.

OR

Press the Wand Release button on the top of the wand to disconnect it from the handheld vacuum.



Wand Release



Floor Nozzle Release

- 2 Attach desired cleaning accessory.**

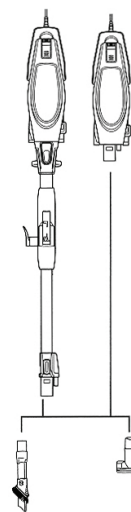

NOTE: Use Setting I for all above-floor accessories.

804008870A



Printed in Mexico
Sc: 09.03.2019

Pgs.:1

Obpn:UV330_IQSG_170621

Shnmdl: UV330_B-brcket dif

Shark[®]

Rocket[™]

Deluxe Pro

Series

INSTRUCTIONS

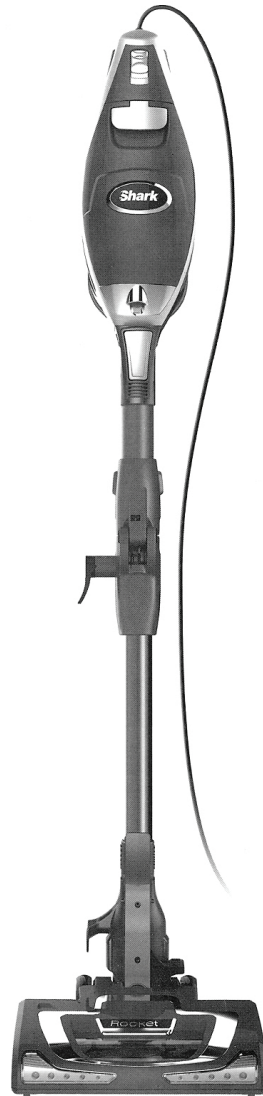

PLEASE READ CAREFULLY AND KEEP FOR FUTURE REFERENCE.

This Owner's Guide is designed to help you get a complete understanding of your Shark Rocket Deluxe Pro.

IMPORTANT SAFETY INSTRUCTIONS

PLEASE READ CAREFULLY BEFORE USE • FOR HOUSEHOLD USE ONLY

⚠ WARNING

To reduce the risk of injury, fire, electric shock, and property damage resulting from improper use of the appliance, carefully observe the following instructions. This unit contains electrical connections and moving parts that potentially present risk to the user.

THE MOTORIZED FLOOR NOZZLE, WAND, AND HANDHELD VACUUM CONTAIN ELECTRICAL CONNECTIONS:

- These are **NOT** serviceable parts.
- **DO NOT** use to vacuum any liquids.
- **DO NOT** immerse in water when cleaning.
- If handheld vacuum/wand is damaged, discontinue use.

- 8 DO NOT** run the vacuum cleaner over the power cord, close a door on the cord, or pull the cord around sharp corners.
- 9** The use of an extension cord is **NOT** recommended.
- 10 DO NOT** leave vacuum cleaner unsupervised when plugged in.
- 11** Keep cord away from heated surfaces.

GENERAL USE

- 1** Inspect power cord and plug for any damage before use. **DO NOT** use vacuum cleaner with a damaged cord or plug. Turn off all controls before plugging in or unplugging the vacuum cleaner. Store your vacuum cleaner with the power cord secured around the two cord hooks.
- 2 DO NOT** use outdoors or on wet surfaces. Use only on dry surfaces.
- 3** Unplug from electrical outlet when not in use and before servicing and cleaning.
- 4** If vacuum cleaner is not working as it should, or has been dropped, damaged, left outdoors, or dropped into water, please call a service center.
- 5 DO NOT** pull or carry vacuum cleaner by the cord or use the cord as a handle.
- 6 DO NOT** unplug by pulling on cord. Grasp the plug, not the cord.
- 7 DO NOT** handle plug or vacuum cleaner with wet hands.
- 12** Always turn off this appliance before connecting or disconnecting motorized nozzle.
- 13** Unplug unit before cleaning or servicing. Brushroll may start unexpectedly, causing risk of injury.
- 14** Use only as described in this manual.
- 15** Keep your work area well lit.
- 16** Keep the vacuum cleaner moving over the carpet surface at all times to avoid damaging the carpet fibers.
- 17 DO NOT** place vacuum cleaner on unstable surfaces such as chairs or tables.
- 18** This vacuum does not stand up on its own and will fall over if not supported, which may result in personal injury.
- 19 DO NOT** put any objects into openings. **DO NOT** use with any opening blocked; keep free of dust, lint, hair, and anything that may reduce airflow.
- 20 DO NOT** allow young children to operate the appliance or use as a toy. Close supervision is necessary when any appliance is used near children.

TECHNICAL SPECIFICATIONS

Voltage: 120V., 60Hz

Watts: 500W

Amps: 4.2A

SAVE THESE INSTRUCTIONS

- 21 DO NOT** use without dust cup and filters in place.
- 22 DO NOT** use if airflow is restricted. If the air paths or the motorized floor nozzle become blocked, turn the vacuum cleaner off and unplug from electrical outlet. Remove all obstructions before you turn on the unit again.
- 23** Keep hair, loose clothing, fingers, and all parts of body away from openings and moving parts.
- 24** Only use manufacturer's recommended attachments.

DUST CUP/FILTERS/ACCESSORIES

Before turning on the vacuum:

- 25** Make sure that all filters are thoroughly dry after routine cleaning.
- 26** Make sure that dust cup and all filters are in place after routine maintenance.
- 27** Make sure accessories are free of blockages and keep openings away from face and body.
- 28** Only use Shark® brand filters and accessories (failure to do so will void the warranty).

GENERAL CLEANING

- 29 DO NOT** vacuum up large objects.
- 30 DO NOT** vacuum up hard or sharp objects that could damage the vacuum cleaner, such as glass, nails, screws, or coins

- 31 DO NOT** vacuum up drywall dust, fireplace ash, or embers. **DO NOT** use as an attachment to power tools for dust collection.
- 32 DO NOT** vacuum up smoking or burning objects such as hot coals, cigarette butts, or matches.
- 33 DO NOT** vacuum up flammable or combustible materials (e.g., lighter fluid, gasoline, or kerosene) or use vacuum in areas where they may be present.
- 34 DO NOT** vacuum up toxic solutions (e.g., chlorine bleach, ammonia, or drain cleaner).
- 35 DO NOT** use in an enclosed space where vapors are present from paint, paint thinner, moth-proofing substances, flammable dust, or other explosive or toxic materials.
- 36 DO NOT** vacuum up any liquids.
- 37 DO NOT** immerse vacuum cleaner in water or other liquids.
- 38** Use extra care when cleaning on stairs.

POLARIZED PLUG

To reduce the risk of electric shock, this vacuum cleaner has a polarized plug (one blade is wider than the other). As a safety feature, this plug will fit into a polarized outlet only one way. If the plug does not fit fully into the outlet, reverse the plug. If it still does not fit, contact a qualified electrician. **DO NOT** force into outlet or try to modify to fit.

GETTING TO KNOW YOUR SHARK® ROCKET® DELUXE PRO

WELCOME!

Congratulations on your purchase. Use this instruction manual to learn about your new vacuum's great features. From assembly to use to maintenance, you will find it all in here.

MAIN UNIT

- A** Power/Selector Switch
- B** Handheld Vacuum
- C** Dust Cup Release
- D** Handheld Vacuum Catch
- E** LED Light
- F** MultiFLEX™ Storage Carry Handle
- G** MultiFLEX Wand Release
- H** MultiFLEX Lock Release Button
- I** MultiFLEX Wand
- J** Lower Wand Release Pedal
- K** Brushroll Indicator Light
- L** Motorized Floor Nozzle
- M** Headlights
- N** Cord Hooks (not visible)
- O** Wall Mount

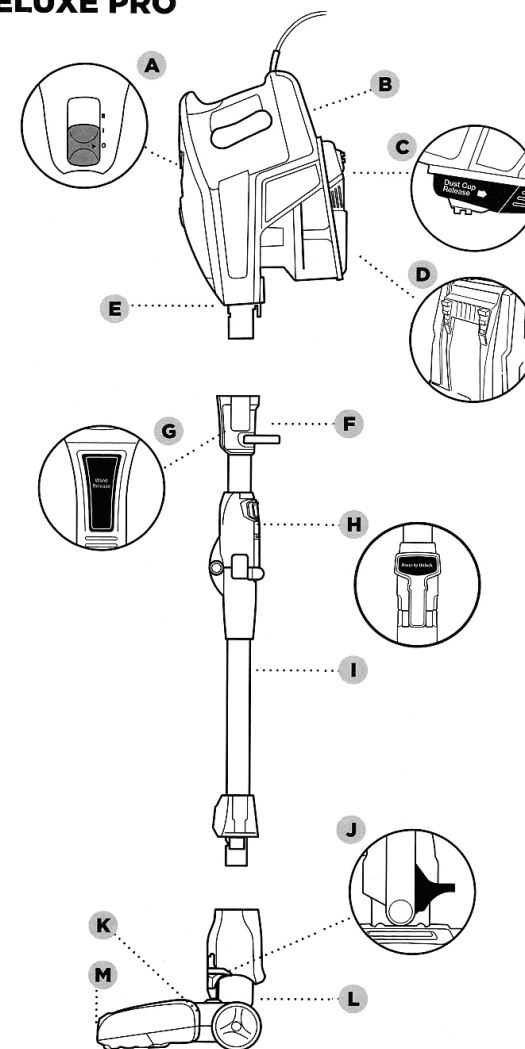
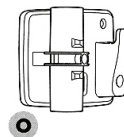

NOTE: Accessories may vary depending on the model. Refer to quick guide, if available. The images shown here are for illustrative purposes only and may be subject to change.

ASSEMBLING YOUR VACUUM

DID YOU KNOW?

The motorized floor nozzle and handheld vacuum have LED lights that illuminate the floor surface being cleaned. The lights turn on automatically in either speed setting.

NOTE: To place in MultiFLEX™ Storage mode, press the MultiFLEX Lock Release Button and gently fold the handheld vacuum forward toward the floor nozzle.

NOTE: Before vacuuming your delicate area rugs or carpet, refer to the manufacturer's recommended cleaning instructions.

WHAT DOES THE BRUSHROLL INDICATOR LIGHT MEAN?

Solid Red

There is a jam in the brushroll area. Turn your vacuum off and remove the blockage.

Solid Green

The brushroll is on and working as it should.

No Light

The brushroll is not spinning.

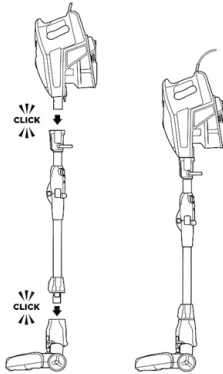

- 1 Insert the wand into the motorized floor nozzle connector, pressing it in until it clicks securely into place.
- 2 Insert the handheld vacuum into the top of the wand, pressing it in until it clicks securely into place.

USING THE MOTORIZED FLOOR NOZZLE

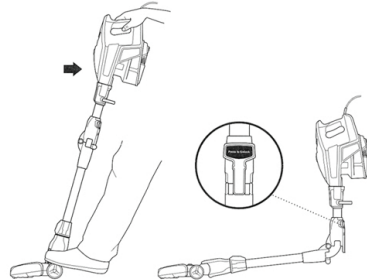

- 1 Slide the Power/Selector Switch to one of the 3 settings:

Setting O: Turns off power.

Setting I: For cleaning bare floors and area rugs.

Setting II: For cleaning high pile carpets.

To start cleaning, recline wand to activate brushrolls.

NOTE: For deep carpet cleaning per ASTM F608 (embedded dirt in carpets) please set to High Pile Carpets (II).

Using the MultiFLEX™ Wand

To easily access hard-to-reach areas under furniture, press the MultiFLEX Lock Release Button to position the wand to a lower angle.

USING YOUR VACUUM IN ABOVE-FLOOR MODE

NOTE: Both power settings provide the same suction power.

TIP: You can attach the handheld vacuum directly to the motorized floor nozzle for convenient stair cleaning.

NOTE: Accessories may vary depending on the model. Refer to quick guide, if available. The images shown here are for illustrative purposes only and may be subject to change.

STEP 1

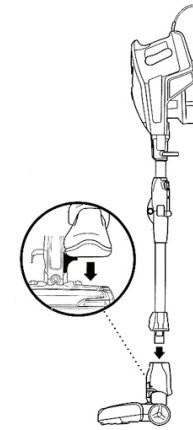

STEP 2

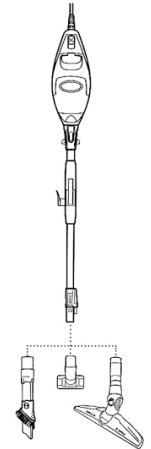

For Long-Reach Cleaning:

- 1 Stand the vacuum upright. Step on the foot pedal and pull the wand up to disconnect it from the motorized floor nozzle.
- 2 Attach desired cleaning accessory to the wand. Press MultiFLEX™ button to vacuum with wand at an angle.

STEP 1

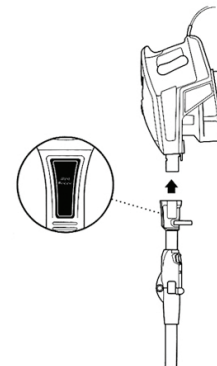

STEP 2

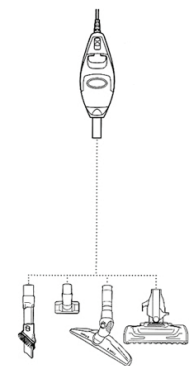

For Short-Reach Cleaning:

- 1 Press the Wand Release button on the top of the wand to disconnect it from the handheld vacuum.
- 2 Attach desired cleaning accessory or motorized floor nozzle to the handheld vacuum. The LED light on the handheld vacuum turns on automatically when the power is on.

STORAGE

TIP: Be sure to use the plastic anchors when mounting into drywall; alternatively you may place screws directly into a stud.

TIP: The carry handle located below the handheld vacuum can also be used to assist in taking the vacuum in and out of MultiFLEX™ Storage mode.

OPTION 1

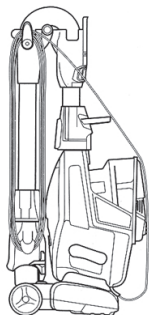

- 1 Looking at the vacuum from the side with the cord hooks, wrap the power cord counterclockwise around the hooks, starting under the bottom hook. Then press the MultiFLEX Wand Lock Release button and gently fold the handheld vacuum forward toward the floor nozzle. Use the handle to carry the vacuum to its storage location.

OPTION 2

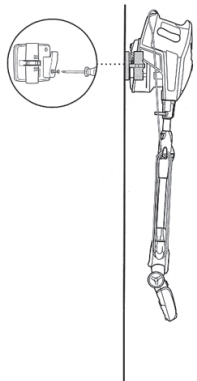

- To take the vacuum out of storage mode, press the MultiFLEX Wand Lock Release button while lifting up the handheld vacuum. When straightened, the wand will lock in place.
- 2 Drill two 5/16" holes into the wall and insert a plastic anchors into the holes. Using a screwdriver, screw the wall mount into the plastic anchors. Hook the catch on the bottom of the handheld vacuum onto the wall mount.

NOTE: Accessories may vary depending on the model. Refer to quick guide, if available. The images shown here are for illustrative purposes only and may be subject to change.

ACCESSORIES

There are a variety of accessories that are compatible with this vacuum series.

The Quick Start Guide shows the select accessories that are included with your model. **NOTE:** Accessories may vary depending on the model. Refer to quick guide, if available. The images shown here are for illustrative purposes only and may be subject to change.

A Duster Crevice Tool

Two cleaning tools in one. The crevice tool provides extended reach into small spaces, while the dusting brush cleans a multitude of surfaces.

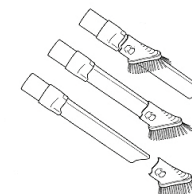

B Upholstery Tool

Perfect for grabbing pet hair and lint from furniture and other upholstered surfaces.

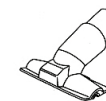

C Hard Floor Hero™ Attachment

Provides outstanding hard floor cleaning for not just surface litter, but also stuck-on dust and debris. It is small enough to get into hard-to-reach areas.

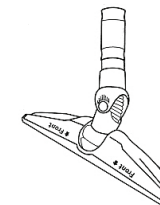

MAINTAINING YOUR VACUUM

WARNING: To reduce the risk of shock and unintended operation, turn off power and unplug unit before servicing.

STEP 1

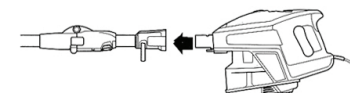

WARNING: Hand-wash filters only with water to prevent damage from cleaning chemicals. Allow ALL filters to air-dry completely before replacing them in the vacuum to prevent liquid from being drawn into electric parts.

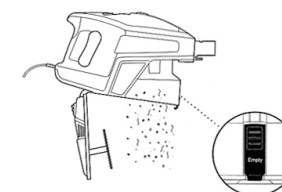

EMPTYING THE DUST CUP

- 1 Press the Wand Release button on the top of the wand to disconnect it from the handheld vacuum.

OR

Remove the dust cup from the handheld vacuum by squeezing the two Dust Cup Release buttons on both sides of the base at the same time, then pull out the dust cup.

IMPORTANT: Clean the dust screen inside the dust cup as required.

NOTE: Empty dust cup when debris reaches the MAX fill line.

RECOMMENDED FILTER CLEANING SCHEDULE:

Pre-Motor Filter Kit
(Foam & Felt)
1080FTV320
Clean once a month.

Post-Motor Filter
1084FTV320
Clean once a year.

MAINTAINING YOUR VACUUM - continued

⚠ WARNING: To reduce the risk of shock and unintended operation, turn off power and unplug unit before servicing.

⚠ WARNING: When cleaning brushroll, be sure not to cut anything other than hair, string, fibers, or other debris.

💡 TIP: Ensure the bottom of the floor nozzle is completely sealed and locked before using.

💡 TIP: You do not need any tools to open the floor nozzle—just a coin.

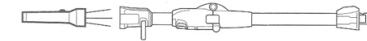
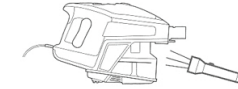

CHECKING FOR BLOCKAGES: HANDHELD VACUUM AND WAND

- 1 Remove the wand from the handheld vacuum and check all dust cup intake openings.
- 2 Remove the floor nozzle from the wand and check the wand for blockages.

STEP 2

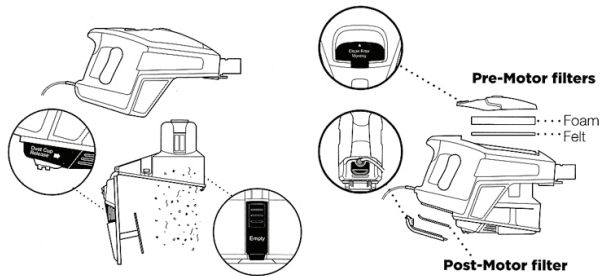

- 2 Hold dust cup over a trash bin and press the Empty button on the front of the dust cup. The bottom lid will open, allowing the debris to fall out.
- 3 Once dust cup is empty, close the bottom lid and insert dust cup back into handheld vacuum, pressing it in until it clicks into place.

CLEANING THE FILTERS

- 1 Access the Pre-Motor foam and felt filters by lifting the latch on the top of the handheld vacuum. Remove and rinse the filters with water. **DO NOT** use soap. Tap loose dirt off filters between washes as needed. Allow filters to air-dry completely, then reinsert them. Insert the felt filter first, then place the foam filter on top of it.
- 2 Access the Post-Motor filter under the handle. Remove and rinse the filter with water. **DO NOT** use soap.

STEP 1

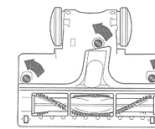

STEP 2

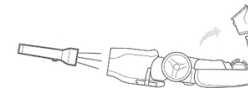

STEP 3

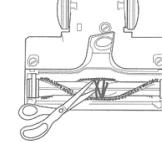

STEP 4

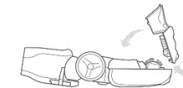

BOTTOM OF FLOOR NOZZLE

- 1 Use a coin to open the three locks on the bottom of the floor nozzle.
- 2 A portion of the base is removable to allow for better access to the brushroll and exposure to the airway. Shine a flashlight from the bottom to check for possible blockages in the airway.
- 3 Remove any string, carpet fibers, or hair that may be wrapped around the brushroll. Loosen debris by running a pair of scissors along the groove in the brushroll.
- 4 To re-assemble, replace base by lining it up along the front of the nozzle. Push down to snap into place until you hear a click. Lock the three locks.

TROUBLESHOOTING GUIDE

⚠ WARNING: To reduce the risk of shock and unintended operation, turn off power and unplug unit before servicing.

Vacuum is not picking up debris. No suction or light suction.
(Refer to Maintenance section for more information.)

- Check filters to see if they need cleaning. Follow instructions for rinsing and completely air-drying the filters before reinserting in the vacuum.
- Dust cup may be full; empty dust cup.
- Check floor nozzle for blockages; clear blockages if required.
- Remove any string, carpet fibers, or hair that may be wrapped around the brushroll.

Vacuum lifts area rugs.

- Suction is powerful. Take care when vacuuming area rugs or rugs with delicately sewn edges.
- Turn off the unit to disengage the brushroll and restart with the Power slider switch.

Brushroll does not spin.

- If Brushroll Indicator Light on the floor nozzle turns red, the brushroll has stopped spinning. Immediately turn off and unplug vacuum and remove blockage. Reconnect to power and turn vacuum back on.
- If Brushroll Indicator Light on the floor nozzle is green, the blockage has been successfully cleared. If the light is still red, please call a service center.

Vacuum turns off on its own.

This vacuum is equipped with a motor-protective thermostat so the vacuum will shut off if it overheats. Should this occur, perform the following steps to restart the motor-protective thermostat:

1. Turn vacuum off and unplug it.
2. Empty dust cup and clean filters (see Maintenance section).
3. Check for blockages in hose, accessories, and inlet openings.
4. Allow unit to cool for a minimum of 45 minutes.
5. Plug in vacuum and turn it on.

NOTE: If vacuum still does not work properly, please call a service center.

WARRANTY REPAIR INFORMATION

If you need service on your unit and this product requires repair during the 90 days warranty period; please go to www.ConsumerServiceRefurbish.com or call the **Refurbished Product Service Center** at 562-946-3531 to obtain the required return authorization (RA) number. Pack the unit properly (the original carton is ideal for this purpose) along with a copy of your purchase receipt and a letter describing the problem. Send the unit freight prepaid and insured to:

Refurbished Product Service Center,
Att: Customer Service Department 13225 Marquardt Avenue Santa Fe Springs, CA 90670

Your unit will be promptly repaired and returned to you. We will refuse to accept delivery of the returned unit unless the assigned RA number appears on the outside of the shipping carton.

Owner's Information
(Keep for your permanent records)

NAME: _____

ADDRESS: _____

CITY: _____ STATE: _____ ZIP CODE: _____

PHONE: _____ E-MAIL: _____

MODEL: _____ SERIAL NO.: _____

REFURBISHED PRODUCT LIMITED NINETY DAYS WARRANTY

The **Refurbished Product Service Center** offers the following WARRANTY to the ORIGINAL purchaser of a product which we have refurbished.

This product that has been refurbished is warranted against any electronic or mechanical defects for a period of NINETY DAYS from the date of the original purchase by the consumer. Since this unit was sold as a refurbished item, the warranty does not apply to any cosmetic appearance items such as scratches. Should a defect occur, the **Refurbished Product Service Center** will repair or, at its option, replace defective unit/parts with new or rebuilt materials without charge for either parts or labor. Replacement unit/parts will be warranted for the remaining portion of the original warranty period.

This warranty does not cover installation or damage from accident, misuse, abuse, improper wiring, incorrect voltage, operating the unit against the instructions in the owner's manual or any product which has been opened, altered, or tampered with.

This warranty does not cover costs for removal and or installation of the unit for repair. Under no circumstances shall the service center be liable for any special, incidental or consequential damages or for any other expenses incurred by reason of use or sale of this product. This warranty is in lieu of any other warranties expressed or implied warranty of merchantability of fitness for particular use or otherwise.

This warranty gives the consumer specific legal rights and they may also have other rights which vary from State to State. Some States do not follow the exclusion or limitation of incidental or consequential damages, hence the above exclusion and limitations may not apply.

Refurbished Product Service Center
13225 Marquardt Avenue Santa Fe Springs, CA 90670.

Printed in Mexico

Sc: 08.01.2018

Pgs.:6

Obpn:UV330_IB_E_170711_MP

Shnmld: UV330_B_Elbrd:i.a.

804108870

804108870

