

**Cordless Vacuum**

814100048

It's important to read this manual prior to using your new product for the first time.

**IMPORTANT SAFETY INSTRUCTIONS**

**FOR HOUSEHOLD USE ONLY • PLEASE READ ALL INSTRUCTIONS BEFORE USING THIS VACUUM.**

**If the charging cord plug does not fit fully into the outlet, reverse the plug. If it still does not fit, contact a qualified electrician. DO NOT force into outlet or try to modify to fit.**

**To reduce the risk of shock and unintended operation, turn off power and remove the battery before servicing.**

**⚠ WARNING**

**To reduce the risk of fire, electric shock, injury, or property damage:**

**THE FLOOR NOZZLE, WAND, AND HAND VACUUM CONTAIN ELECTRICAL CONNECTIONS:**

- This vacuum consists of a motorized nozzle, wand, and hand vacuum. These components contain electrical connections, electrical wiring, and moving parts that potentially present risk to the user.
- Before each use, carefully inspect all parts for any damage. If a part is damaged, discontinue use.
- Use only identical replacement parts.
- This vacuum contains no serviceable parts.
- Use only as described in this manual. **DO NOT** use the vacuum for any purpose other than those described in this manual.
- With the exception of the filters and dust cup, **DO NOT** expose any parts of the vacuum to water or other liquids.
- Keep the appliance and its cord out of reach of children. **DO NOT** allow the appliance to be used by children. **DO NOT** allow to be used as a toy. Close supervision is necessary when used near children.

**GENERAL USE**

- This appliance can be used by persons with reduced physical, sensory, or mental capabilities or lack of experience or knowledge if they have been given supervision or instruction concerning use of the appliance in a safe way and understand the hazards involved. Cleaning and user maintenance shall not be done by children.
- Always turn off the vacuum before connecting or disconnecting any current carrying hoses, motorized nozzles, chargers, batteries, or other electrical or mechanical parts.
- DO NOT** handle plug or vacuum with wet hands.
- DO NOT** use without dust cup, filters, and brushroll in place.
- Only use Shark® branded filters and accessories.
- DO NOT** put any objects into nozzle or accessory openings. **DO NOT** use with any opening blocked; keep free of dust, lint, hair, and anything that may reduce airflow.
- DO NOT** use if nozzle or accessory airflow is restricted. If the air paths or the motorized floor nozzle become blocked, turn the vacuum off. Remove all obstructions before you turn on the unit again.
- Keep nozzle and all vacuum openings away from hair, face, fingers, uncovered feet, or loose clothing.

- DO NOT** use if vacuum is not working as it should, or has been dropped, damaged, left outdoors, or dropped into water.
- Use extra care when cleaning on stairs.
- DO NOT** leave the vacuum unattended while powered on.
- When powered on, keep the vacuum moving over the carpet surface at all times to avoid damaging the carpet fibers.
- DO NOT** place vacuum on unstable surfaces such as chairs or tables.
- DO NOT** use to pick up:
  - Liquids
  - Large objects
  - Hard or sharp objects (glass, nails, screws, or coins)
  - Large quantities of dust (including drywall, fireplace ash, or embers). **DO NOT** use as an attachment to power tools for dust collection.
  - Smoking or burning objects (hot coals, cigarette butts, or matches)
  - Flammable or combustible materials (lighter fluid, gasoline, or kerosene)
  - Toxic materials (chlorine bleach, ammonia, or drain cleaner)
- DO NOT** use in the following areas:
  - Poorly lit areas
  - Wet or damp surfaces
  - Outdoor areas
  - Spaces that are enclosed and may contain explosive or toxic fumes or vapors (lighter fluid, gasoline, kerosene, paint, paint thinners, mothproofing substances, or flammable dust)
- Turn off the vacuum before plugging in or unplugging the charger.
- Turn off the vacuum before any adjustment, cleaning, maintenance, or troubleshooting.
- During cleaning or routine maintenance, **DO NOT** cut anything other than hair, fibers, or string wrapped around the brushroll.
- Allow all filters to air-dry completely before replacing in the vacuum to prevent liquid from being drawn into electric parts.
- DO NOT** modify or attempt to repair the vacuum or the battery yourself, except as indicated in this manual. **DO NOT** use the battery or vacuum if it has been modified or damaged. Damaged or modified batteries may exhibit unpredictable behavior resulting in fire, explosion, or risk of injury. **DO NOT** unplug by pulling on the cord. To unplug, grasp the plug, not the cord.

28. Turn off all controls before unplugging.

**BATTERY PACK**

- The battery is the power source for the vacuum. Carefully read and follow all charging instructions.
- To prevent unintentional starting, ensure the vacuum is powered off before picking up or carrying the vacuum. **DO NOT** carry the appliance with your finger on the power switch.
- Use only Shark charger dock XDCKWS640AE or XDCKWS642AE. Use of an incorrect charger may result in no charging and/or unsafe conditions.
- Use only with Shark battery pack XSBT420.
- Keep the battery away from all metal objects such as paper clips, coins, keys, nails, or screws. Shorting the battery terminals increases the risk of fire or burns.
- Under abusive conditions, liquid may be ejected from the battery. Avoid contact with this liquid, as it may cause irritation or burns. If contact occurs, flush with water. If liquid contacts eyes, seek medical help.
- Battery should not be stored at temperatures below 37.4°F (3°C) or above 104°F (40°C) to maintain long-term battery life.
- DO NOT** charge battery at temperatures below 40°F (5°C) or above 104°F (40°C).
- Store the appliance indoors. **DO NOT** use or store it below 37.4°F (3°C). Ensure the appliance is at room temperature before operating.
- DO NOT** expose the battery to fire or temperatures above 265°F (130°C) as it may cause explosion.

**SAVE THESE INSTRUCTIONS**

**ASSEMBLY**

- Slide the **Wand** onto the neck of the **PowerFins Floor Nozzle** until it clicks into place.
- Align the **Hand Vacuum** nozzle opening with the top of the wand and slide it on until it clicks into place.
- Make sure the **Dock Base** is facing upright. Slide the **Charging Post** into the slot on back of dock until it clicks.
- Place the dock on the floor near a wall outlet. Plug the **Power Cord** into the outlet, then connect the cord to the port on the back of the charging post.
- Store cleaning accessories on the mount on the dock.

For proper operation, ensure all components are completely connected and clicked into place.

**NOTE:** Your Quick Guide shows the accessories that are included with your model.

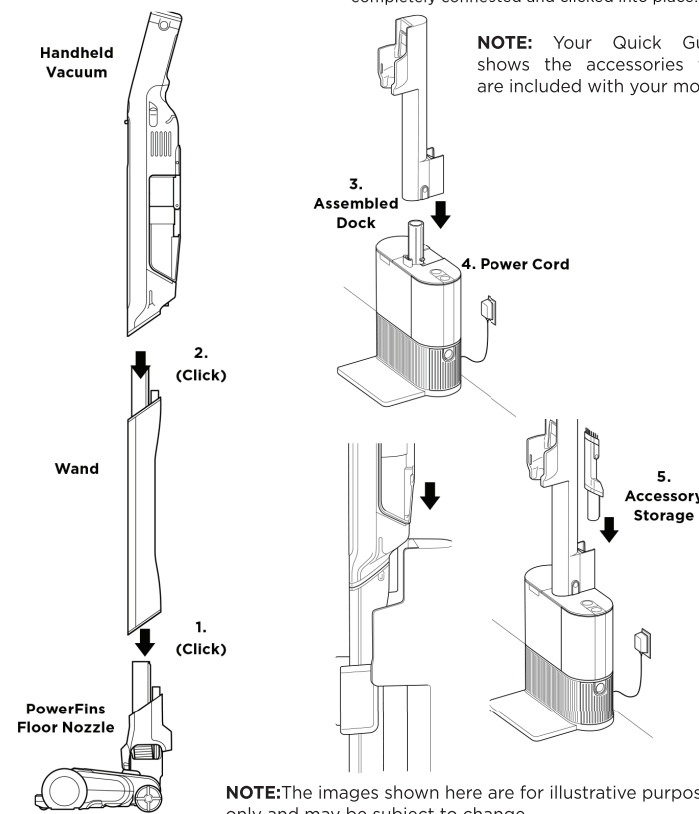

**NOTE:**The images shown here are for illustrative purposes only and may be subject to change.

**NOTE:** Once the charging post is installed, it can't be removed.

**LI-ION BATTERY**

Prior to first use, charge the battery completely.

**LED BATTERY POWER AND CHARGING INDICATORS**

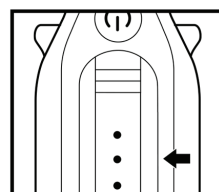

**Charging**

- |            |            |             |             |
|------------|------------|-------------|-------------|
| ●●●        | ●●         | ●           | ○           |
| ○          | ○          | ○           | ○           |
| ○          | ○          | ○           | ○           |
| Low Charge | Mid Charge | Nearly Full | Full Charge |

**NOTE:** LEDs will shut off 5 minutes after achieving full charge.

**In Use**

- |             |            |            |              |           |
|-------------|------------|------------|--------------|-----------|
| ●●●         | ●●         | ●          | ○            | ○         |
| ○           | ○          | ○          | ○            | ○         |
| ○           | ○          | ○          | ○            | ○         |
| Full Charge | Mid Charge | Low Charge | Nearly Empty | No Charge |

**RECYCLING THE LI-ION BATTERY**

When the Shark® Li-ion battery needs to be replaced, dispose of it or recycle it in accordance with local ordinances or regulations. In some areas, it is illegal to place spent lithium-ion batteries in the trash or in a municipal solid waste stream. Return spent batteries to an authorized recycling center or to the retailer for recycling. Contact your local recycling center for information on where to drop off the spent battery.

**NOTE:** The Shark battery, like all lithium-ion batteries, will naturally decrease in capacity over time from the 100% capacity of a new battery.

**CHARGING**

**CHARGING WHILE IN STORAGE MODE**

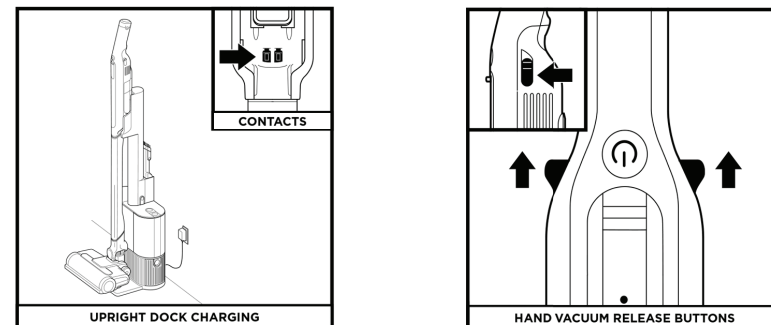

Charge the unit by placing it on the dock. Make sure the contacts on the wand are aligned with the contacts on the charging post.

When charging is complete and you need to use the unit again, lift it off the dock.

To detach the hand vacuum from the wand, slide the release buttons on both sides of the handle, then lift off the hand vacuum.

To reattach the hand vacuum to the wand, align the nozzle opening over the top of the wand and slide it on until it clicks into place.

**NOTE:** When the unit is docked properly, the charging lights on the hand vacuum will blink, indicating that charging has begun. When charging is complete, all three indicator lights will remain on for 5 minutes, then shut off.

**NOTE:** The main unit comes with a partial charge. For maximum runtime, charge fully before first use. Leaving the unit plugged in will not damage battery life.

**REMOVING THE BATTERY**

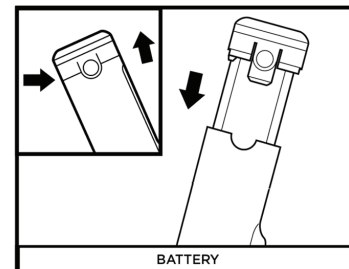

To remove the battery from the hand vacuum, press the release tabs on the battery cap and slide out the battery. To reinstall, slide the battery into the compartment in the handle until it clicks into place.

**USING YOUR VACUUM**

**CONTROLS AND CLEANING MODES**

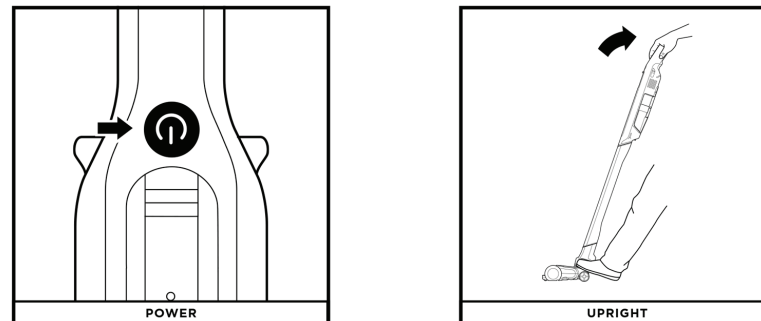

Press the **On/Off** button on the handle to turn on power. To turn off power, press the button again.

Use the PowerFins floor nozzle for powerful cleaning on both bare floors and carpets. The brushroll is activated when the hand vacuum is connected and powered on.

**REFURBISHED PRODUCT LIMITED NINETY DAYS WARRANTY**

The **Refurbished Product Service Center** offers the following WARRANTY to the ORIGINAL purchaser of a product which we have refurbished.

This product that has been refurbished is warranted against any electronic or mechanical defects for a period of NINETY DAYS from the date of the original purchase by the consumer. Since this unit was sold as a refurbished item, the warranty does not apply to any cosmetic appearance items such as scratches. Should a defect occur, the **Refurbished Product Service Center** will repair or, at its option, replace defective unit/parts with new or rebuilt materials without charge for either parts or labor. Replacement unit/parts will be warranted for the remaining portion of the original warranty period.

This warranty does not cover installation or damage from accident, misuse, abuse, improper wiring, incorrect voltage, operating the unit against the instructions in the owner's manual or any product which has been opened, altered, or tampered with.

This warranty does not cover costs for removal and or installation of the unit for repair. Under no circumstances shall the service center be liable for any special, incidental or consequential damages or for any other expenses incurred by reason of use or sale of this product. This warranty is in lieu of any other warranties expressed or implied warranty of merchantability of fitness for particular use or otherwise.

This warranty gives the consumer specific legal rights and they may also have other rights which vary from State to State. Some States do not follow the exclusion or limitation of incidental or consequential damages, hence the above exclusion and limitations may not apply.

**Refurbished Product Service Center**  
13225 Marquardt Avenue Santa Fe Springs, CA 90670.

**WARRANTY REPAIR INFORMATION**

If you need service on your unit and this product requires repair during the 90 days warranty period; please go to [www.ConsumerServiceRefurbish.com](http://www.ConsumerServiceRefurbish.com) or call the **Refurbished Product Service Center** at 562-946-3531 to obtain the required repair authorization (RA) number. Pack the unit properly (the original carton is ideal for this purpose) along with a copy of your purchase receipt and a letter describing the problem. Send the unit freight prepaid and insured to:

**Refurbished Product Service Center,**  
Att: Customer Service Department  
13225 Marquardt Avenue Santa Fe Springs, CA 90670

Your unit will be promptly repaired and returned to you.

We will refuse to accept delivery of the returned unit unless the assigned RA number appears on the outside of the shipping carton.

**Owner's Information**  
(Keep for your permanent records)

NAME: \_\_\_\_\_  
ADDRESS: \_\_\_\_\_  
CITY: \_\_\_\_\_  
STATE: \_\_\_\_\_  
ZIP CODE: \_\_\_\_\_  
PHONE: \_\_\_\_\_  
E-MAIL: \_\_\_\_\_  
MODEL: \_\_\_\_\_  
SERIAL NO.: \_\_\_\_\_

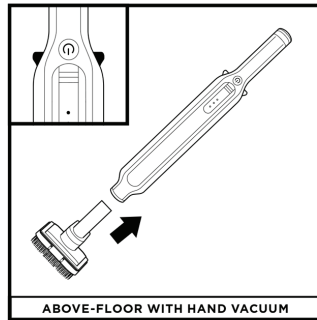

Detach the hand vacuum to clean above-floor areas. Slide the release buttons on both sides of the handle, and lift the hand vacuum off the wand. To attach an accessory to the hand vacuum, slide it into the opening in the nozzle. To remove, slide the release buttons on both sides of the handle and slide out the accessory.

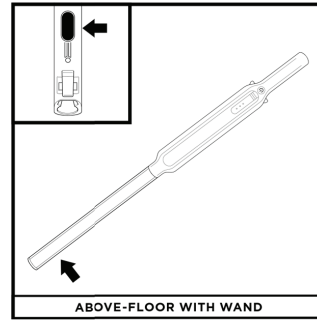

To detach the floor nozzle from the wand, step on the nozzle while pressing the nozzle release button at the bottom of the wand. Lift the wand to remove it. To reattach the wand, align it over the neck of the floor nozzle, then slide it on until it clicks into place.

**NOTE:** All accessories are compatible with both the wand and the hand vacuum.

#### USING THE DOCK

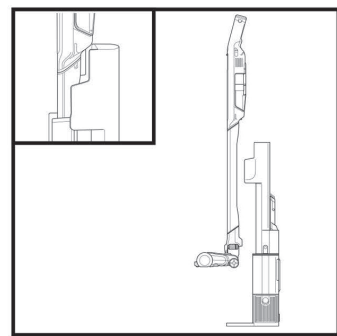

Place the vacuum on the dock in a downward motion. Once properly attached, the auto evacuation process will begin. The evacuation cycle will last for 10 seconds.

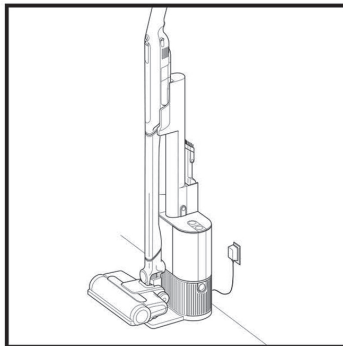

Once evacuation is complete, the vacuum will continue charging until it is removed from the dock.

**WS642 Only:** In its default mode, the dust cup evacuation will happen automatically every time the vacuum is placed onto the dock. If you would like to turn this feature off, press the mute button on the top side of the dock base. While the mute icon is illuminated, the automatic empty feature will be disabled and the dock will only charge the unit. To turn the automatic empty feature back on, simply press the mute button again.

**Note: do not remove the vacuum while the evacuation cycle is taking place.**

#### MAINTAINING YOUR VACUUM

##### EMPTYING THE BIN DUST CUP

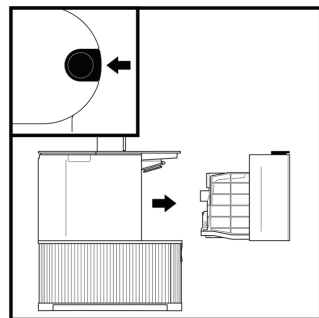

The dock dust bin holds up to 30 days worth of dust and debris. Empty the dock dust bin when the debris level approaches the max fill line. To detach the bin, press the Dust Bin Release button on the top right side of the base, then slide out the bin.

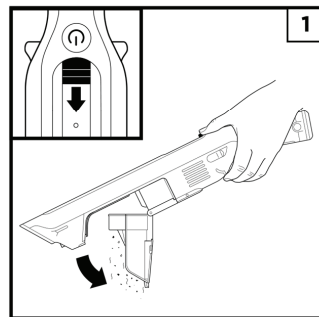

1. With the power off, slide the release button forward, and the dust cup will swing open. Tap the filter screen lightly to knock off dust and debris.

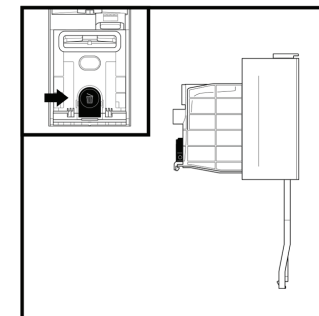

To empty the bin, insert it 3 inches into trash bag and press the release button with the trash can icon. The bin lid will open releasing the debris. Lightly tap the bin against the inside of the trash receptacle to knock off any remaining debris. Reinstall the bin by sliding into the slot in the base until it clicks into place.

#### CLEANING THE DUST CUP AND FILTER

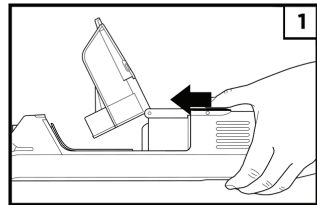

1. With the dust cup open and the power off, press the filter release latch below the handle and pull out the filter housing.

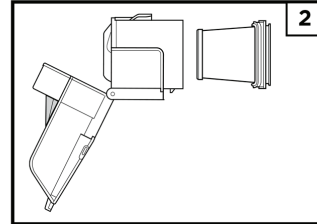

2. Press the tabs on both sides of the filter housing and pull out the filter. To clean the filter, hand-wash only with water and let air-dry for at least 24 hours before reinstalling. To reinstall the filter, slide it back into the housing, then slide the housing back into place.



3. To deep-clean the dust cup, open the dust cup 90 degrees until it clicks open. Wipe clean with cloth. Rinse the dust cup with water, and wipe clean with a damp cloth. Allow to air-dry completely (at least 24 hours). When the dust cup is completely dry, reinstall the dust cup.

##### CLEANING DOCK FILTERS

For best results, regularly clean and replace the filters in the dock base. To clean filters, rinse with cold water ONLY to prevent damage from cleaning chemicals. Allow all filters to air-dry for at least 24 hours before reinstalling them to prevent liquid from being drawn into electrical parts.

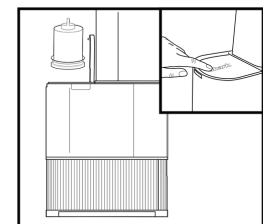

To access the pre-motor filter, lift up the cover on the top left side of the dock base. Lift out the foam filter by the handle then remove the felt filter underneath. Tap the filters over the trash, then rinse with cold water. Allow the filter to air-dry for 24 hours before reinstalling.

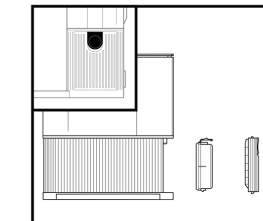

To access the post-motor filter, press the button at the top of the filter door, then tilt the door away from the dock and lift. Remove the Post-Motor Filter from the base. To reinstall the post-motor filter, insert it into the base and replace the filter door.

#### NOZZLE MAINTENANCE

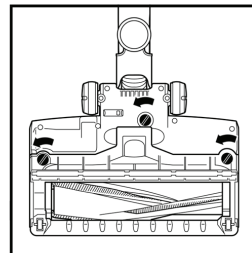

1. Turn off the vacuum.
2. Press the nozzle release button to detach the nozzle from the wand.
3. Using a coin, turn the 3 locks counterclockwise to open, then lift off the cover and tilt back the neck of the nozzle.

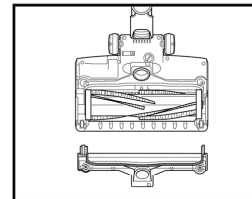

4. Clear any blockages and remove any debris from the brushroll and floor nozzle.
5. With the cover removed, wipe the brushroll clean with a dry towel.
6. Replace the cover by sliding the tabs into the slots. Press down firmly on all sides. Turn locks clockwise to close.

#### CHECKING FOR BLOCKAGES IN THE VACUUM

If you run over a hard or sharp object or notice a noise change while vacuuming, check for blockages or objects caught in the brushroll.

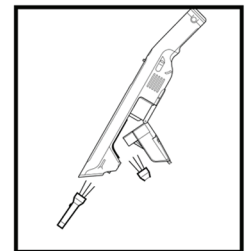

##### Checking for Blockages in the Hand Vacuum:

1. Turn off the vacuum.
2. Remove the hand vacuum from the wand.
3. Check all intake openings to the dust cup and remove any debris or blockages.

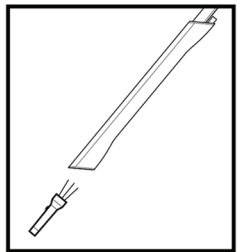

##### Checking for Blockages in the Wand:

1. Turn off the vacuum.
2. Detach the hand vacuum and floor nozzle from the wand.
3. Check both ends of the wand for blockages and debris.
4. Clear away any debris or blockages.

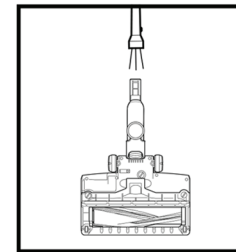

##### Checking for Blockages in the Floor Nozzle:

1. Turn off the vacuum.
2. Detach the wand.
3. Using a coin, turn the 3 locks on the bottom of the nozzle counterclockwise to open.
4. Lift off the nozzle cover and tilt back the neck of the nozzle.
5. Check the opening and remove any debris.
6. Replace the cover by sliding the tabs into the slots. Press down firmly on all sides. Turn the locks clockwise to close.

#### CHECKING FOR BLOCKAGES IN THE DOCK

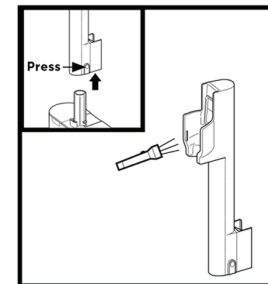

##### Checking for Blockages in the Charging Post:

1. Unplug the dock.
2. Remove the vacuum from the dock.
3. Press the latch on the side of the charging post and lift away from the dock base.
4. Check the end of the charging post and top of the dock base for any debris or blockages.

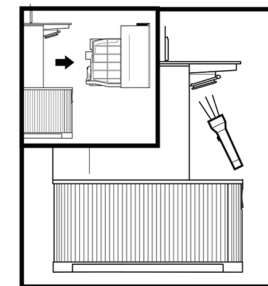

##### Checking for Blockages in the Dock:

1. Unplug the dock.
2. Remove the vacuum from the dock.
3. Remove the dust bin from the dock.
4. Check the exit for any debris or blockages.

**NOTE:** Your Quick Guide shows the accessories that are included with your model. The images shown here are for illustrative purposes only and may be subject to change.

#### MAINTAINING YOUR VACUUM

##### TROUBLESHOOTING

**WARNING:** To reduce the risk of shock and unintended operation, turn off power and remove the battery before servicing.

Vacuum is not picking up debris. No suction or light suction. Third indicator light on hand vacuum is solid yellow. (Refer to Checking for Blockages section for more information.)

1. Dust cup may be full; empty dust cup.
2. Check floor nozzle for blockages; clear blockages if required.
3. Remove any string, carpet fibers, or hair that may be wrapped around the brushroll.
4. Check connection between hand vacuum and wand for blockages; clear blockages if required.
5. Check filters to see if they need cleaning. Follow instructions for rinsing and completely air-drying the filters before reinstalling them.

##### Vacuum lifts area rugs.

1. Make sure you are not engaging Boost mode. Take care when vacuuming area rugs or rugs with delicately sewn edges.
2. Turn off the unit to disengage from the carpet, then restart.

##### My vacuum has a PowerFins nozzle but the brushroll doesn't spin.

1. Immediately turn off the vacuum. Remove any blockages before turning the vacuum back on. Make sure the hand vacuum is tilted back far enough for the brushroll to engage while in use.
2. If the floor nozzle has headlights and they are not illuminated, there is a connection issue between the hand vacuum, wand, and nozzle. Try detaching the parts, then reconnecting them.

##### Vacuum turns off on its own.

There are several possible reasons for the vacuum turning off on its own, including blockages, battery issues, and overheating. If vacuum turns off on its own, perform the following steps:

1. Turn on the vacuum and check the battery indicator lights on the hand vacuum. If recharging is needed, make sure vacuum power is off before plugging in the charger.
2. Empty dust cup and clean filters (See the Cleaning the Dust Cup and Filter section).
3. Check wand, accessories, and inlet openings and remove any blockages.
4. Allow unit and battery to cool for at least 45 minutes, until they return to room temperature.
5. Press the On/Off switch to restart the vacuum.

##### Battery Indicator Lights on hand vacuum are flashing.

- Top LED is solid yellow (Fig. A): Nozzle clog. (See the Maintaining Your Vacuum section.)
- Bottom LED is flashing (Fig. B): Battery needs to be charged.

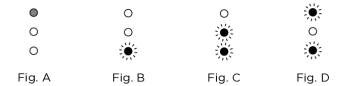

##### Contact a Service center if you experience any of the indications listed below:

- Bottom and middle LEDs are flashing (Fig. C): Overcurrent or short.
- Top and bottom LEDs are flashing (Fig. D): Motor is overheating.
- Middle LED is flashing (Fig. E): Overspeed.
- Top LED is flashing (Fig. F): Communication.
- Top LED blinking yellow (Fig. G): There may be an electrical problem with the nozzle.

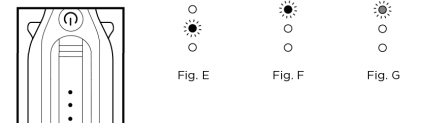

##### PLEASE READ CAREFULLY AND KEEP FOR FUTURE REFERENCE.

Illustrations may differ from actual product. We are constantly striving to improve our products; therefore the specifications contained herein are subject to change without notice.

This product may be covered by one or more U.S. patents.



814100048

PRINTED IN MEXICO SC: 07-17-2023\_TAB  
OBPN: WS640AE\_IB\_E\_MP\_220624  
SHNMDL: WS640AE\_B Elbrd: M.C.

Please be sure to read the enclosed Shark® Owner's Guide prior to using your unit.

# QUICK START GUIDE

## WHAT'S INSIDE

- (A) Hand Vacuum
- (B) Wand
- (C) PowerFins™ Floor Nozzle
- (D) WANDVAC® System Auto Empty Docking Station
- (E) Battery Pack
- (F) Duster Crevice Tool

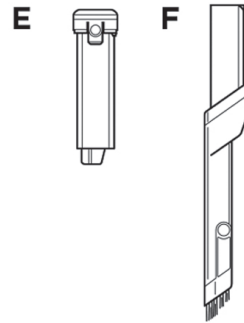

1. Slide the wand onto the neck of the floor nozzle until it clicks into place.
2. Slide the hand vacuum nozzle over the wand until it clicks into place.
3. Slide the Docking Station post onto the Auto Empty base until it clicks into place.
4. Place the dock on the floor near a wall outlet. Plug the power cord into the outlet.
5. Store cleaning accessories in the on-board accessory storage on the back of the dock post.

For proper operation, ensure all components are completely connected and clicked into place.

**NOTE:** Accessories may vary depending on the model.

## ASSEMBLY

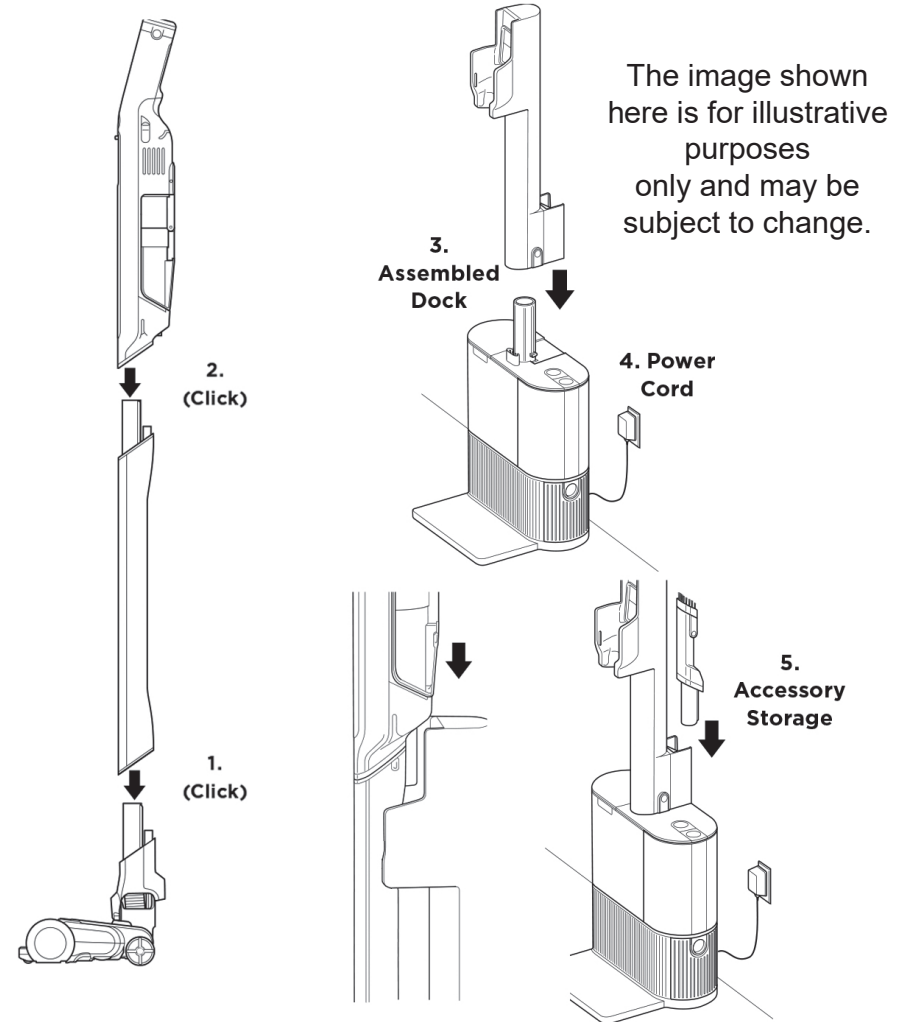

8 1 4 0 0 0 0 4 8 A

PRINTED IN MEXICO / SC: 07-17-2023

MODEL: WS640AE\_B / Elbrd: M.C. / 0.25P / OBPN: N/A