

SONY

BRAVIA XR

Please read this manual carefully before operating your unit and retain for future reference.

804106908

Safety Information

Notice for customers in the United States of America

Supplier's Declaration of Conformity

Trade Name: SONY
Model: XR-85X90K / XR-85X90CK / XR-75X90K / XR-75X90CK / XR-65X90K / XR-65X90CK / XR-55X90K / XR-55X90CK
Responsible Party: Sony Electronics Inc.

FCC Related Information

This equipment has been tested and found to comply with the limits for a Class B digital device, pursuant to Part 15 of the FCC Rules. These limits are designed to provide reasonable protection against harmful interference in a residential installation. This equipment generates, uses and can radiate radio frequency energy and, if not installed and used in accordance with the instructions, may cause harmful interference to radio communications. However, there is no guarantee that interference will not occur in a particular installation. If this equipment does cause harmful interference to radio or television reception, which can be determined by turning the equipment off and on, the user is encouraged to try to correct the interference by one or more of the following measures:

- Reorient or relocate the receiving antenna.
- Increase the separation between the equipment and receiver.
- Connect the equipment into an outlet on a circuit different from that to which the receiver is connected.
- Consult the dealer or an experienced radio/TV technician for help.

Pursuant to FCC regulations, you are cautioned that any changes or modifications not expressly approved in this manual could void your authority to operate this equipment.

Safety and Regulatory

FCC regulations restrict operation of this device to indoor use only.

Notice for customers in the United States of America and Canada

This equipment complies with FCC/IC radiation exposure limits set forth for an uncontrolled environment and meets the FCC radio frequency (RF) Exposure Guidelines and RSS-102 of the IC radio frequency (RF) Exposure rules. This equipment should be installed and operated keeping the radiator at least 20 cm or more away from person's body (excluding extremities: hands, wrists, feet and ankles).

This device and its antenna(s) must not be co-located or operating with any other antenna or transmitter except Grant condition.

Compatible Wall-Mount Bracket Information

Use the following Sony Wall-Mount Bracket with your TV model.

Sony TV Model No.	Sony Wall-Mount Bracket Model No.
XR-75X90K / 75X90CK / 65X90K / 65X90CK / 55X90K / 55X90CK	SU-WL855*1

Use with other Wall-Mount Brackets*2 may cause instability and could result in property damage or injury.

- *1 Only for limited region/country/model.
- *2 For instructions on using the Wall-Mount Bracket with your TV please go to <https://www.sony.com/am/support> for your TV model and download "Wall-Mount Bracket".

Before setting up your TV

Some TV models are packaged with a detached Table-Top Stand so you can mount your TV to a wall right away. See "Installing the TV to the Wall" if you want to mount the TV to a wall. If you are not mounting the TV to a wall, you will need to attach the Table-Top Stand (refer to the Setup Guide).

- Be sure to consider the following while setting up your TV:
 - Disconnect all cables when carrying the TV.
 - Two or more persons (three or more persons for 214.8 cm (85 inches) and above TV) are needed to transport a large TV set.
 - Correct hand placement while carrying the TV is very important for safety and to avoid damage.

XR-85X90K / 85X90CK

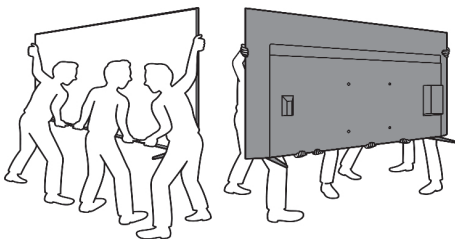

XR-75X90K / 75X90CK / 65X90K / 65X90CK / 55X90K / 55X90CK

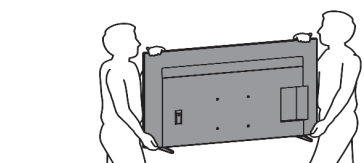

- Ensure your TV has adequate ventilation, refer to the safety documentation.
- For best picture quality, do not expose the screen to direct illumination or sunlight.
- Avoid installing the TV in a room with reflective wall and floor materials.
- Avoid moving the TV from a cold area to a warm area. Sudden room temperature changes may cause moisture condensation. This may cause the TV to show poor picture and/or poor color. Should this occur, allow moisture to evaporate completely before powering the TV on.

*Note: The image shown here is for illustrative purposes only and may be subject to change. The actual number of ports and their locations may vary depending on the model.

Securing the TV



Sony strongly recommends taking measures to prevent the TV from toppling over. Unsecured TVs may topple and result in property damage, serious bodily injury or even death.

Preventing the TV from Toppling

- Secure the TV to a wall and/or Stand.
- Do not allow children to play or climb on furniture and TV sets.
- Avoid placing or hanging items on the TV.
- Never install the TV on:
 - slippery, unstable and/or uneven surfaces.
 - furniture that can easily be used as steps, such as a chest of drawers.
- Install the TV where it cannot be pulled, pushed, or knocked over.
- Install the TV so that the TV's Table-Top Stand does not protrude out from the Stand (not supplied). If the Table-Top Stand protrudes out from the Stand, it may cause TV set to topple over, fall down, and cause personal injury or damage to the TV.



- Route all AC power cords and connecting cables so that they are not accessible to curious children.

Recommended Measures to Secure the TV

Consider the following measures when securing your TV to a Stand (not supplied).

- 1 Secure the Stand for the TV.
 - Make sure the Stand can adequately support the weight of the TV. Use two angle braces (not supplied) to secure the Stand. For each angle brace use the appropriate hardware to:
 - Attach one side of the angle brace to the wall stud.
 - Attach the other side to the Stand.

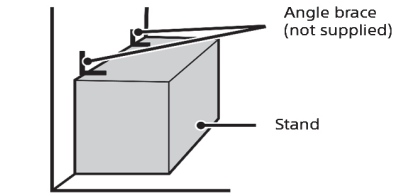

- 2 Secure the TV to the Stand.
 - Use the optional hardware listed as follows (not supplied):
 - M6 machine screws (screwed into the TV's rear cover).
 - A screw or similar (attach it to the Stand).
 - Rope or chain (strong enough to support the weight of the TV). Make sure that there is no excess slack in the rope or chain.

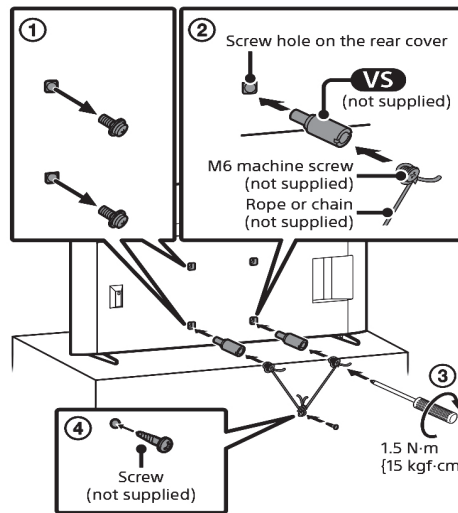

The length of the M6 machine screw differs depending on the rope or chain diameter. Please refer to below illustration.

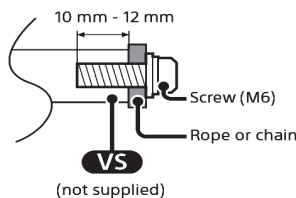

- 3 Anchor the TV to the wall by using bolts, wall anchor and chain (or rope).

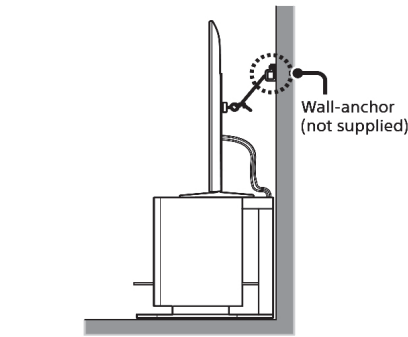
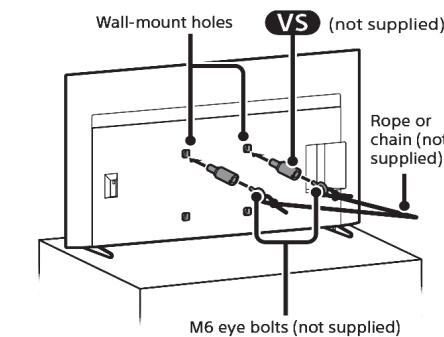

Please refer to below illustration for M6 eye bolt length.

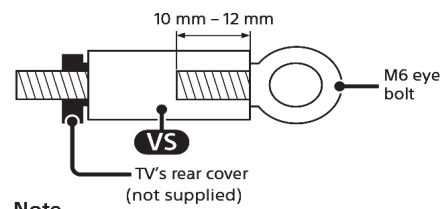

Note

- Your TV is shipped with screws attached to the rear of the TV depending on the TV model. (They are fastened in the screw holes for wall mounting.) Be sure to remove the upper two screws prior to anchoring the TV to a wall.
- Securing the TV to the Stand without securing the TV and the Stand to the wall provides minimum protection against the TV toppling over. For further protection, be sure to follow the three measures recommended.

Using TV as Part of Audio System

Note

- Before connecting cables, disconnect the AC power cord of both TV and AV receiver.
- Refer to the instruction manual of the Audio system with S-CENTER OUT terminal for detail.

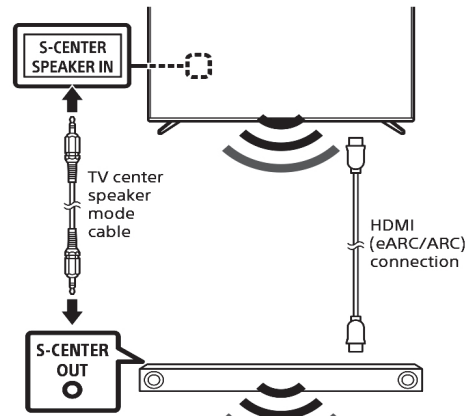

The cables mentioned in this guide is not supplied with your unit.

Remote Control and TV

The remote control shape, layout, availability and function of remote control buttons may vary depending on your region/country/TV model/TV settings*1.

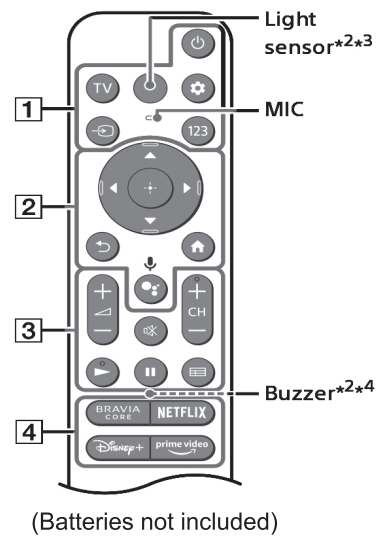

- 1 **(Power)**
TV: Display TV channel list or switch to input.

(Quick settings): Display Quick Settings.

(Input): Display and select the input source, etc.

123 (Control menu): Display the Control menu.

- 2 **▲ / ▼ / ◀ / ▶ / ⊕:** On screen menu navigation and selection.

(Back)

(Home)

(Google Assistant) /

(Microphone): Use Google Assistant*5*6.

- 3 **▲ / ▼ (Volume)**

(Mute)*7

CH + / - (Channel)

▶ / ||

(Guide): Display the digital program guide of TV or Cable/Satellite box*8.

- 4 **App buttons**

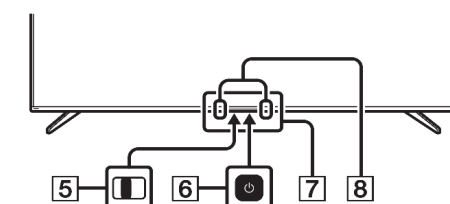

- 5 **BUILT-IN MIC SWITCH*5:** Turn on/off the built-in MIC.

- 6 **(Power)**

- 7 **Remote Control sensor / Light sensor / LED**

- 8 **Built-in MIC*5*6*9:** To enable the built-in MIC, press the Google Assistant button on the remote control and follow the on-screen instructions.

- *1 For other remote control models, refer to the online Help Guide for details.
- *2 RMF-TX900U only. To see the model name of the remote control, open the remote control cover and see the label on the remote control.
- *3 The remote control backlight will illuminate when the light sensor detects the ambient light is low. Automatic illumination of the backlight can be turned off.
- *4 The buzzer will emit a sound when you use the remote finder function. Refer to the online Help Guide for details.
- *5 Only for limited region/country/model/language.
- *6 Google Assistant requires an Internet connection.
- *7 Accessibility shortcut is available by pressing and holding **(Mute)**.
- *8 [Cable/Satellite box setup] setting is required.
- *9 Power consumption will increase when the built-in MIC is enabled as it is always listening.



For more information, refer to the Help Guide. Press **(Input)** on the remote control and select [Help]. If [Help] does not exist, select [Edit] and add [Help].

Guidelines for IR Remote Control

- Point your remote control directly at the IR sensor located on your TV.
- Make sure that no objects are blocking the path between the remote control and the IR sensor on your TV.

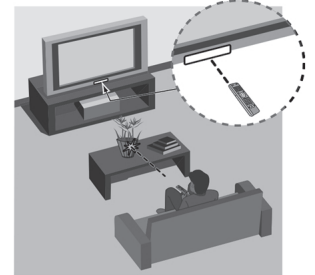

- Fluorescent lamps can interfere with your remote control; try turning off the fluorescent lamps.
- If you are having problems with the remote control, reinsert or replace your batteries and make sure that they are correctly inserted.

Installing the TV to the Wall (Wall mount kit not supplied)

Using the optional Wall-Mount Bracket (SU-WL855 only)* (not supplied)

Wall-Mount Bracket Installation Information

For instructions on Wall-Mount Bracket installation, see the Installation Information (Wall-Mount Bracket) on the Sony Customer Support website for your TV model at the following address.

- Follow the instruction guide provided with the Wall-Mount Bracket for your model. Sufficient expertise is required in installing this TV, especially to determine the strength of the wall for withstanding the TV's weight.
- Sony is not liable for any damage or injury caused by mishandling or improper installation.
- The length of the screw for Wall-Mount Bracket differs depending on the Wall-Mount Bracket thickness. Please refer to below illustration.

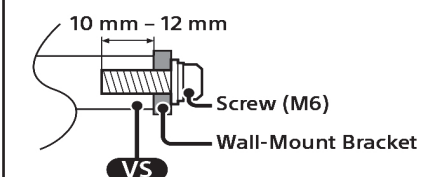

- Be sure to store the unused screws and Table-Top Stand in a safe place until you are ready to attach the Table-Top Stand. Keep the screws away from small children.

Note

- Read the supplied safety documentation for additional safety information.

* Only for limited region/country/model.

Using the optional Wall-Mount Bracket (Except SU-WL855) (not supplied)

This TV's instruction manual only provides the steps to prepare the TV for Wall-Mount installation before it is installed on the wall. Your TV can be mounted to a wall using a suitable Wall-Mount Bracket (not supplied). If the Table-Top Stand is attached to the TV, the TV may require detaching the Table-Top Stand; see "Detaching the Table-Top Stand

from the TV".
Prepare the TV for the Wall-Mount Bracket before making cable connections.

For product protection and safety reasons, Sony strongly recommends that installation of your TV on the wall be performed by qualified professionals. Do not attempt to install it yourself.

- Follow the instruction guide provided with the Wall-Mount Bracket for your model. Sufficient expertise is required in installing this TV, especially to determine the strength of the wall for withstanding the TV's weight.
- The screws for installing the Wall-Mount Bracket to the TV are not supplied.
- The length of the screw for Wall-Mount Bracket differs depending on the Wall-Mount Bracket thickness. Please refer to below illustration.

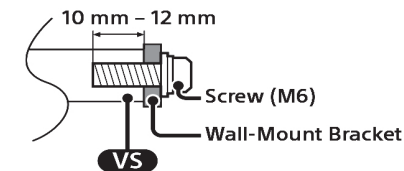

- Refer to the following table for wall-mount hole pattern.

Model Name	Wall-mount hole pattern
	a × b
XR-85X90K / 85X90CK	400 × 400 mm
XR-75X90K / 75X90CK	300 × 300 mm
XR-65X90K / 65X90CK	300 × 300 mm
XR-55X90K / 55X90CK	300 × 300 mm

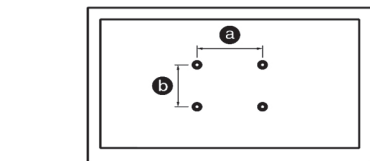

- Be sure to store the unused screws and Table-Top Stand in a safe place until you are ready to attach the Table-Top Stand. Keep the screws away from small children.

Note
Read the supplied safety documentation for additional safety information.

* Only for limited region/country/model.

- Remove the screws from the rear of the TV.
- Attach the Wall-Mount Attachment (not supplied with the TV) to the rear of the TV (to make it parallel with the wall).
- Attach the Wall-Mount Bracket (not supplied) using the screws (not supplied).

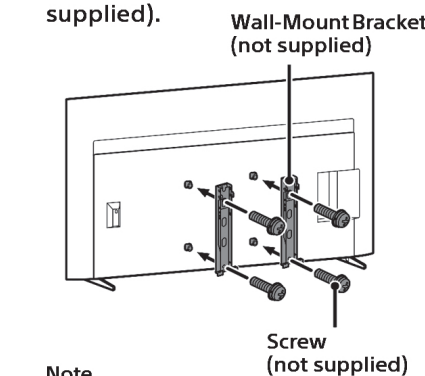

- Note**
- If using an electric screwdriver, set the torque at approximately 1.5 N·m {15 kgf·cm}.
 - Be sure to fasten the Wall-Mount Attachment when attaching them to the TV. Use only a flat head screwdriver to install the Wall-Mount Attachment. Use of another tool might result in over torquing the Wall-Mount Attachment and damaging the TV.

Detaching the Table-Top Stand from the TV

- Remove one side of the Table-Top Stand at a time. Firmly hold the Table-Top Stand securely with both hands while the other people lift up the TV.
- Repeat the previous step and remove the other side of the Table-Top Stand.

- Note**
- Three or more people are required to detach the Table-Top Stand.
 - Be careful not to use excessive force while detaching the Table-Top Stand from the TV as it may cause the TV set to fall resulting in personal injury or physical damage to the TV.
 - Take care when handling the Table-Top Stand to prevent damage to the TV.
 - Be careful when lifting the TV as the Table-Top Stand is detached, the Table-Top Stand may topple over and cause personal injury.

- Take care when removing the Table-Top Stand from the TV to prevent it from falling over and damaging the surface that the TV is sitting on.
- Do not remove the Table-Top Stand for any reason other than to install corresponding accessories on the TV.
- Be sure the TV is vertical before turning on. To avoid uneven picture uniformity do not power on the TV with the LCD panel facing down.

Optional Camera and Microphone Unit (not supplied) Cable Management

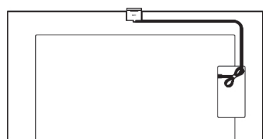

Troubleshooting

General troubleshooting for issues like: black screen, no sound, frozen picture, TV does not respond, or network is lost, do the following steps.

- Restart your TV by pressing the power button on the remote control for about five seconds. The TV will restart. If the TV does not recover, try unplugging the AC power cord then press the power button on the TV and release it. Wait for two minutes, and plug in the AC power cord. Or, press the power button on the TV for about 40 seconds until the TV turns off.
- Refer to the Help menu shown below.
- Connect your TV to the Internet and perform a software update. Sony recommends you to keep your TV software updated. Software updates provide new features and performance improvements.
- Perform the factory data reset.

When you plug in the TV, the TV may not be able to turn on for a while even if you press the power button on the remote control or the TV.

It takes time to initialize the system. Wait for about one minute, then operate it again.

How to reset the TV to factory settings

WARNING: The reset will clear all of your customized settings including the parental lock setting.

- You can reset the TV to factory settings by selecting [Factory data reset]. How to select [Factory data reset], refer to the online Help Guide.
- To force factory data reset, unplug the AC power cord. Press and hold \odot button on the TV, then plug in the AC power cord.
- For security purposes, be sure to remove all personal and account information before discarding, selling or passing your TV to someone else by: unlinking/unregistering, signing out of and deactivating all network services as well as factory reset the TV.

The remote control does not function.

- Replace the batteries.

The parental lock password has been forgotten.

- Enter 4357 for the PIN and enter the new PIN.

For more information on troubleshooting, refer to the Help Guide. Press \odot (Input) on the remote control and select [Help]. If [Help] does not exist, select [Edit] and add [Help].

Specifications

System

TV system: Depend on your country/area selection/TV model
 NTSC: American TV Standard
 ATSC (8VSB Terrestrial): ATSC compliant 8VSB
 NEXTGEN TV: ATSC 3.0 compliant (Single tuner)
 QAM on cable: ANSI/SCTE 07 2000 (Does not include CableCARD functionality)

Channel coverage: Depend on your country/area selection/TV model
 Analog terrestrial: 2 - 69 / Digital terrestrial: 2 - 69*¹
 Analog Cable: 1 - 135 / Digital Cable: 1 - 135

Panel system: LCD (Liquid Crystal Display) Panel, LED Backlight
 Speaker output: 10 W + 10 W + 5 W + 5 W
 Wireless technology
 Protocol IEEE 802.11a/b/g/n/ac
 Bluetooth® Version 4.2

Input/Output jacks

CABLE/ANTENNA
 75 ohm external terminal for RF inputs
 \odot / \ominus VIDEO IN / S-CENTER SPEAKER IN
 Video/Audio input (mini jack)
 S-center speaker input (mini jack)

HDMI IN 1/2/3/4 (HDCP 2.3-compatible)

Video:
 4096 × 2160p (60 Hz)*^{2,3}, 4096 × 2160p (24 Hz)*², 3840 × 2160p (60 Hz)*³, 3840 × 2160p (24, 30 Hz), 1080p (30, 60, 120 Hz), 1080i (60 Hz), 720p (30, 60 Hz), 720/24p, 480p, PC Formats*⁴
 3840 × 2160p (120 Hz)*^{3,5}

Audio:
 In eARC (Enhanced Audio Return Channel) mode
 Refer to the online Help Guide for details.

Except eARC mode
 5.1 channel linear PCM: 32/44.1/48/88.2/96/176.4/192 kHz 16/20/24 bits, Dolby Audio, Dolby Atmos, DTS

eARC/ARC (Enhanced Audio Return Channel/Audio Return Channel) (HDMI IN 3 only)*⁶

In eARC mode
 Refer to the online Help Guide for details.

In ARC mode
 Two channel linear PCM: 48 kHz 16 bits, Dolby Audio, Dolby Atmos, DTS

\odot DIGITAL AUDIO OUT (OPTICAL)
 Digital optical jack (Two channel linear PCM: 48 kHz 16 bits, Dolby Audio, DTS)

\leftarrow 1, \rightarrow 2
 USB port 1 supports High Speed USB (USB 2.0)
 USB port 2 supports Super Speed USB (USB 3.2 Gen 1)

\oplus LAN
 10BASE-T/100BASE-TX connector (Depending on the operating environment of the network, connection speed may differ. The communication rate and quality are not guaranteed.)
 Home Network supported files and formats*⁴

REMOTE
 RS-232C mini jack, IR IN mini jack
 These jacks are for receiving the external control signal.

Power and others

Power requirements
 110 V - 240 V AC, 50/60 Hz (U.S.A.)
 120 V AC, 60 Hz)

Power consumption
 In use
 XR-85X90K / 85X90CK: 390 W
 XR-75X90K / 75X90CK: 329 W
 XR-65X90K / 65X90CK: 244 W
 XR-55X90K / 55X90CK: 205 W
 In standby*^{7,8}

Less than 0.5 W with 120 V AC and less than 0.5 W with 240 V AC

Screen size (measured diagonally) (Approx.)

XR-85X90K / 85X90CK: 214.8 cm / 84.6 inches (85" class)
 XR-75X90K / 75X90CK: 189.3 cm / 74.5 inches (75" class)
 XR-65X90K / 65X90CK: 163.9 cm / 64.5 inches (65" class)
 XR-55X90K / 55X90CK: 138.8 cm / 54.6 inches (55" class)

Display resolution (horizontal × vertical) (pixels)
 3840 × 2160

Output rating
 500 mA (for USB 1), 900 mA (for USB 2)

Dimensions (Approx.) (w × h × d) (mm) / (inches)

with stand
 Standard position:
 XR-85X90K / 85X90CK:
 1901 × 1125 × 469 / 74 ⁷/₈ × 44 ³/₈ × 18 ¹/₂
 XR-75X90K / 75X90CK:
 1675 × 992 × 398 / 66 × 39 ¹/₈ × 15 ³/₄
 XR-65X90K / 65X90CK:
 1452 × 863 × 331 / 57 ¹/₄ × 34 × 13 ¹/₈
 XR-55X90K / 55X90CK:
 1233 × 740 × 331 / 48 ⁵/₈ × 29 ¹/₄ × 13 ¹/₈

without stand
 XR-85X90K / 85X90CK:
 1901 × 1090 × 73 / 74 ⁷/₈ × 43 × 2 ⁷/₈
 XR-75X90K / 75X90CK:
 1675 × 962 × 73 / 66 × 37 ⁷/₈ × 2 ⁷/₈
 XR-65X90K / 65X90CK:
 1452 × 834 × 72 / 57 ¹/₄ × 32 ⁷/₈ × 2 ⁷/₈
 XR-55X90K / 55X90CK:
 1233 × 711 × 72 / 48 ⁵/₈ × 28 × 2 ⁷/₈

wall-mount hole pattern
 XR-85X90K / 85X90CK: 400 × 400 mm
 XR-75X90K / 75X90CK: 300 × 300 mm
 XR-65X90K / 65X90CK: 300 × 300 mm
 XR-55X90K / 55X90CK: 300 × 300 mm
 wall-mount screw size (mm)
 M6 (length: see "Installing the TV to the Wall".)

Stand width (Approx.) (mm) / (inches)

XR-85X90K / 85X90CK: 1567 / 61 ³/₄
 XR-75X90K / 75X90CK: 1361 / 53 ⁵/₈
 XR-65X90K / 65X90CK: 1174 / 46 ¹/₄
 XR-55X90K / 55X90CK: 1027 / 40 ¹/₂

Mass (Approx.) (kg) / (lb.)

with stand
 XR-85X90K / 85X90CK: 47.5 / 104.7
 XR-75X90K / 75X90CK: 35.8 / 78.9
 XR-65X90K / 65X90CK: 24 / 52.9
 XR-55X90K / 55X90CK: 18.5 / 40.8
 without stand
 XR-85X90K / 85X90CK: 45.8 / 100.9
 XR-75X90K / 75X90CK: 34.4 / 75.8
 XR-65X90K / 65X90CK: 22.9 / 50.5
 XR-55X90K / 55X90CK: 17.4 / 38.4

Others

Optional accessories
 Wall-Mount Bracket: SU-WL855 (XR-75X90K / 75X90CK / 65X90K / 65X90CK / 55X90K / 55X90CK only)
 Camera and Microphone Unit: CMU-BC1
 Operating temperature: 0 °C - 40 °C / 32 °F - 104 °F

- *1 2 - 36 for NEXTGEN TV scanning range in U.S.A.
- *2 When 4096 × 2160p is input and [Wide mode] is set to [Normal], the resolution is displayed as 3840 × 2160p. To display 4096 × 2160p, set [Wide mode] setting to [Full 1] or [Full 2].
- *3 Refer to the on screen menu to set [HDMI signal format].
- *4 Refer to the online Help Guide for details.
- *5 HDMI IN 3 & 4 only. Use the Ultra High Speed HDMI Cable to connect.
- *6 Connect your audio system to the HDMI IN 3 to route TV audio to your audio system.
- *7 Specified standby power is reached after the TV finishes necessary internal processes.
- *8 Standby power consumption will increase when your TV is connected to the network.

Note

- Optional accessories availability depends on countries/region/TV model/stock.
- Design and specifications are subject to change without notice.
- Subscriptions for services and applications may be required and additional terms, conditions and/or charges may apply when using Google Assistant.

Licensing Information

- The terms HDMI, HDMI High-Definition Multimedia Interface, and the HDMI Logo are trademarks or registered trademarks of HDMI Licensing Administrator, Inc.
- Dolby, Dolby Vision, Dolby Atmos, Dolby Audio, and the double-D symbol are trademarks of Dolby Laboratories Licensing Corporation. Manufactured under license from Dolby Laboratories. Confidential unpublished works. Copyright © 1992-2021 Dolby Laboratories. All rights reserved.
- Gracenote, the Gracenote logo and logotype, "Powered by Gracenote" logo are either registered trademarks or trademarks of Gracenote, Inc. in the United States and/or other countries.
- Google, Google TV and related logos are trademarks of Google LLC.
- For DTS patents, see <http://patents.dts.com>. Manufactured under license from DTS, Inc. DTS, Digital Surround, and the DTS logo are registered trademarks or trademarks of DTS, Inc. in the United States and other countries. © 2020 DTS, Inc. ALL RIGHTS RESERVED.
- Netflix is a registered trademark of Netflix, Inc.
- TUXERA is a registered trademark of Tuxera Inc. in the US and other countries.
- All other trademarks are the property of their respective owners.



REFURBISHED PRODUCT LIMITED NINETY DAYS WARRANTY

The **Refurbished Product Service Center** offers the following WARRANTY to the ORIGINAL purchaser of a product which we have refurbished.

This product that has been refurbished is warranted against any electronic or mechanical defects for a period of NINETY DAYS from the date of the original purchase by the consumer. Since this unit was sold as a refurbished item, the warranty does not apply to any cosmetic appearance items such as scratches. Should a defect occur, the **Refurbished Product Service Center** will repair or, at its option, replace defective unit/parts with new or rebuilt materials without charge for either parts or labor. Replacement unit/parts will be warranted for the remaining portion of the original warranty period.

This warranty does not cover installation or damage from accident, misuse, abuse, improper wiring, incorrect voltage, operating the unit against the instructions in the owner's manual or any product which has been opened, altered, or tampered with.

This warranty does not cover costs for removal and/or installation of the unit for repair. Under no circumstances shall the service center be liable for any special, incidental or consequential damages or for any other expenses incurred by reason of use or sale of this product. This warranty is in lieu of any other warranties expressed or implied warranty of merchantability of fitness for particular use or otherwise.

This warranty gives the consumer specific legal rights and they may also have other rights which vary from State to State. Some States do not follow the exclusion or limitation of incidental or consequential damages, hence the above exclusion and limitations may not apply.

Refurbished Product Service Center
 13225 Marquardt Avenue Santa Fe Springs, CA 90670.

WARRANTY REPAIR INFORMATION

If you need service on your unit and this product requires repair during the 90 days warranty period; please go to www.ConsumerServiceRefurbish.com or call the **Refurbished Product Service Center** at 562-946-3531 to obtain the required return authorization (RA) number. Pack the unit properly (the original carton is ideal for this purpose) along with a copy of your purchase receipt and a letter describing the problem. Send the unit freight prepaid and insured to:

Refurbished Product Service Center,
Att: Customer Service Department 13225 Marquardt Avenue Santa Fe Springs, CA 90670

Your unit will be promptly repaired and returned to you. We will refuse to accept delivery of the returned unit unless the assigned RA number appears on the outside of the shipping carton.

Owner's Information (Keep for your permanent records)

NAME: _____
 ADDRESS: _____
 CITY: _____ STATE: _____ ZIP CODE: _____
 PHONE: _____ E-MAIL: _____
 MODEL: _____ SERIAL NO.: _____

SONY

Television

Setup Guide

BRAVIA XR

XR-55X90K / 55X90CK

804006908A

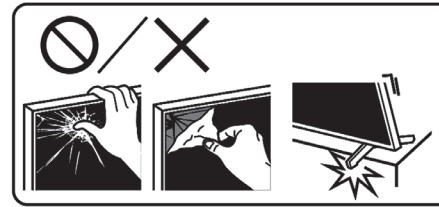

1

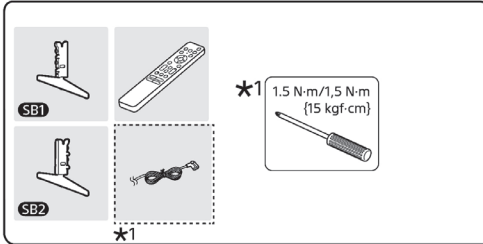

2



Accessory type and quantity may vary depending on the model.

3

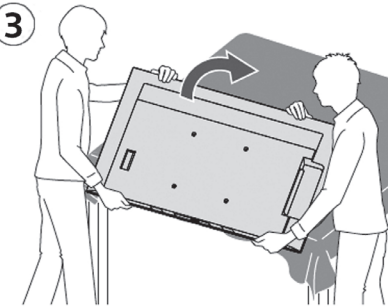

4

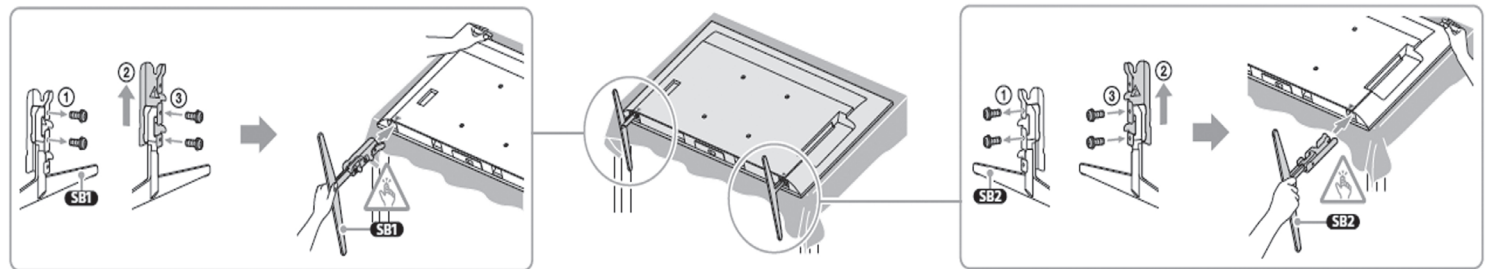
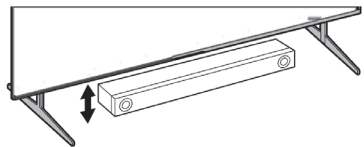
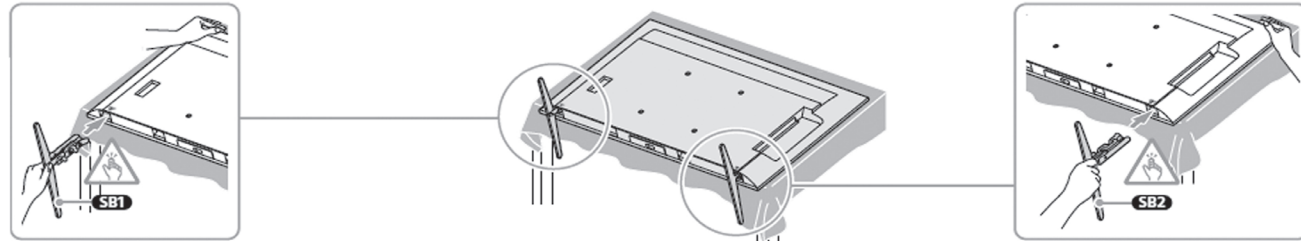
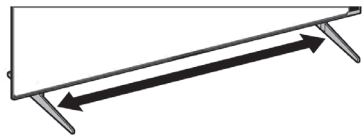

*1 Refer Reference Guide

*2 Only for limited region/country/model.

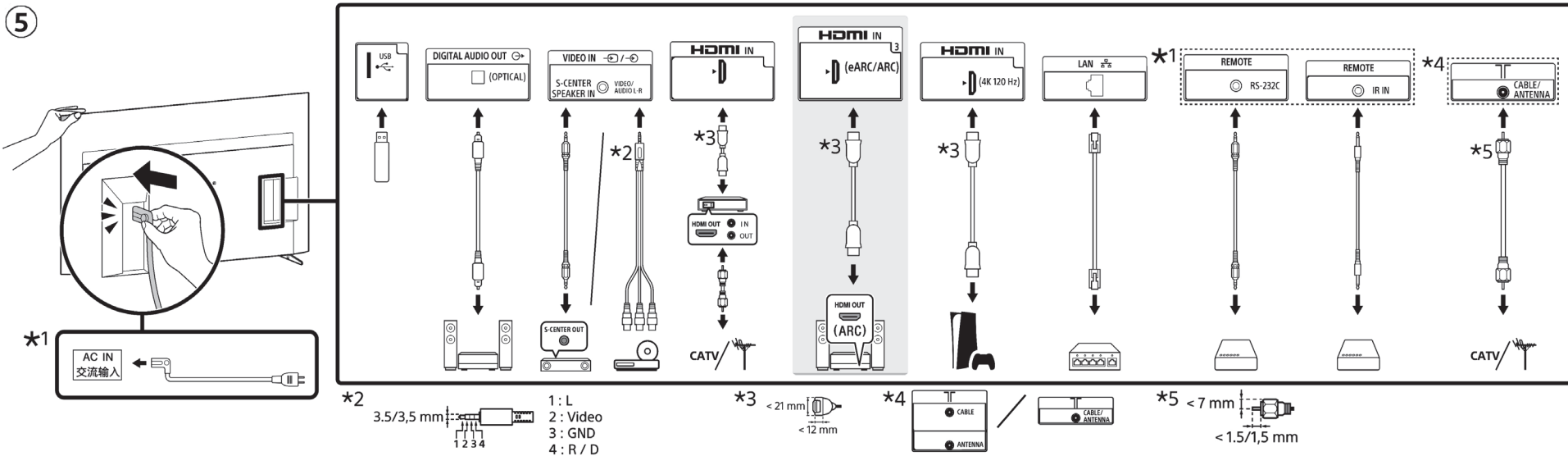

The cables mentioned in this guide is not supplied with your unit.

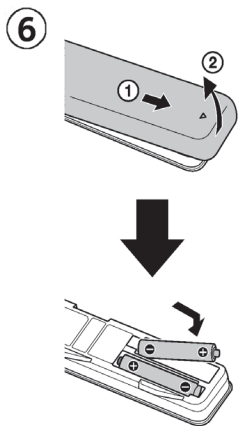

(Batteries not included)

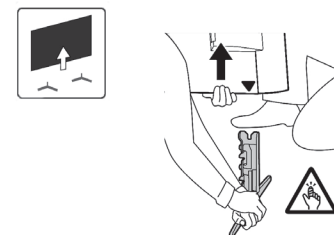
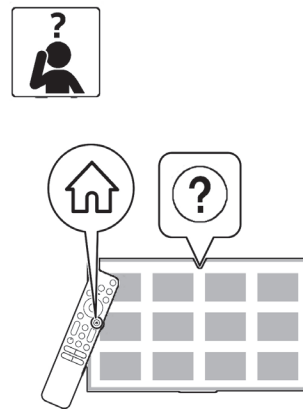
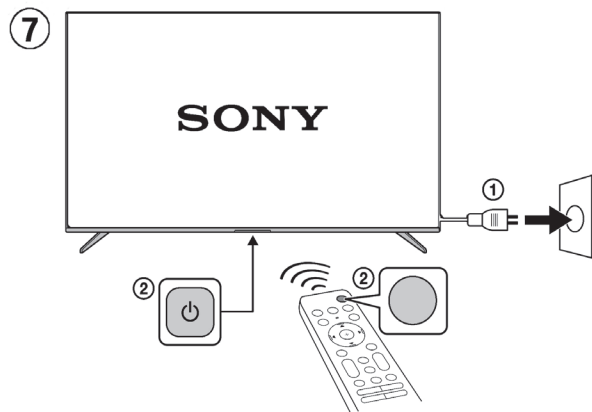

The remote control varies depending on the model: The buttons on the remote control may have a different name or location than the remote control shows in this manual.

The image shown here is for illustrative purposes only and may be subject to change.

Illustrations may differ from actual product. We are constantly striving to improve our products; therefore the specifications contained herein are subject to change without notice.

8 0 4 0 0 6 9 0 8 A



PRINTED IN MEXICO
OBPN:5-038-985-11(1)
SHNMDL:XR55X90CK_B
SC: 28-02-2023 / 2P / Elbrd:J.E.