

# SONY BRAVIA

XR-100X92 / 75X90J / 75X90J / 75X90CJ / 65X90J / 65X90CJ / 55X90J / XR55X90CJ / 50X90J

# Television Reference Guide

Please read this manual carefully before operating your unit and retain for future reference. 804106587

## Internet security caution

It is strongly recommended for security purposes to connect your TV to the Internet via a router/modem that includes router functionality. Direct connection of your TV to the Internet may expose your TV to a security threat such as extraction or tampering of content or personal information.

## WARNING

To reduce the risk of fire or electric shock, do not expose this product to rain or moisture. The product must never be exposed to dripping, splashing, or spilling liquids of any kind.



This symbol is intended to alert the user to the presence of uninsulated "dangerous voltage" within the product enclosure that may be of sufficient magnitude to constitute a risk of electric shock to persons.

This symbol is intended to alert the user to the presence of important operating and maintenance (servicing) instructions in the literature accompanying the product.

Danger of explosion if battery is incorrectly replaced. Replace only with the same or equivalent type.

## CAUTION

To prevent electric shock and blade exposure, do not use this AC plug with an extension cord, receptacle or other outlet unless the blades can be fully inserted.

- Operate the TV only on 110 V – 240 V AC (U.S.A./Canada 120 V AC).
- Operate the TV only on DC 19.5 or 24 V (For model with supplied AC adapter)\*.
- Refer to the Reference Guide to know the exact value.

## How to care for your BRAVIA TV

Safety is very important. Unplug the TV and other connected equipment from the wall outlet before you begin cleaning your TV. The TV should also be placed on a stable surface to prevent it from toppling over (refer to Reference Guide). If you have young children or pets at home, check regularly to ensure the TV is securely fastened.

## CLEANING

- When cleaning, be sure to unplug the power cord to avoid any chance of electric shock.
- Clean the cabinet of the TV with a dry soft cloth.
- Wipe the screen gently with a soft cloth.
- Stubborn stains may be removed with a cloth slightly moistened with a solution of mild soap and warm water.
- Do not spray water or detergent directly on the TV set. It may drip to the bottom of the screen or exterior parts, and may cause a malfunction.
- If using a chemically pretreated cloth, please follow the instruction provided on the package.
- Never use strong solvents such as a thinner, alcohol or benzine for cleaning.
- Do not plug in the TV into the wall outlet until the moisture from cleaning has evaporated.
- Periodic vacuuming of the ventilation openings is recommended to ensure to proper ventilation.

# Important Safety Instructions

- Read these instructions.
- Keep these instructions.
- Read all warnings.
- Follow all instructions.
- Do not use this apparatus near water.
- Clean only with dry cloth.
- Do not block any ventilation openings. Install in accordance with the manufacturer's instructions.
- Do not install near any heat sources such as radiators, heat registers, stoves, or other apparatus (including amplifiers) that produce heat.
- Do not defeat the safety purpose of the polarized or grounding-type plug. A polarized plug has two blades with one wider than the other. A grounding type plug has two blades and a third grounding prong. The wide blade or the third prong are provided for your safety. If the provided plug does not fit into your outlet, consult an electrician for replacement of the obsolete outlet.
- Protect the power cord from being walked on or pinched particularly at plugs, convenience receptacles, and the point where they exit from the apparatus.
- Only use attachments/accessories specified by the manufacturer.
- Use only with the cart, stand, tripod, bracket, or table specified by the manufacturer, or sold with the apparatus. When a cart is used, use caution when moving the cart/apparatus combination to avoid injury from tip-over.
- Unplug this apparatus during lightning storms or when unused for long periods of time.
- Refer all servicing to qualified service personnel. Servicing is required when the apparatus has been damaged in any way, such as power-supply cord or plug is damaged, liquid has been spilled or objects have fallen into the apparatus, the apparatus has been exposed to rain or moisture, does not operate normally, or has been dropped.

Please observe the Additional Safety DOs and DON'Ts to avoid electric shock, short-circuit, fire, bodily injury or property damage.

## Safety Information

### Notice for customers in the United States of America

#### Supplier's Declaration of Conformity

Trade Name: SONY  
Model: XR-100X92 / XR-75X90J / XR-75X90CJ / XR-65X90J / XR-65X90CJ / XR-55X90J / XR-55X90CJ / XR-50X90J  
Responsible Party: Sony Electronics Inc.

#### FCC Related Information

This equipment has been tested and found to comply with the limits for a Class B digital device, pursuant to Part 15 of the FCC Rules. These limits are designed to provide reasonable protection against harmful interference in a residential installation. This equipment generates, uses and can radiate radio frequency energy and, if not installed and used in accordance with the instructions, may cause harmful interference to radio communications. However, there is no guarantee that interference will not occur in a particular installation. If this equipment does cause harmful interference to radio or television reception, which can be determined by turning the equipment off and on, the user is encouraged to try to correct the interference by one or more of the following measures:

- Reorient or relocate the receiving antenna.
- Increase the separation between the equipment and receiver.
- Connect the equipment into an outlet on a circuit different from that to which the receiver is connected.
- Consult the dealer or an experienced radio/TV technician for help.

Pursuant to FCC regulations, you are cautioned that any changes or modifications not expressly approved in this manual could void your authority to operate this equipment.

#### Safety and Regulatory

5 GHz bands are restricted to indoor operations only.

#### Notice for customers in the United States of America

This equipment complies with FCC/IC radiation exposure limits set forth for an uncontrolled environment and meets the FCC radio frequency (RF) Exposure Guidelines and RSS-102 of the IC radio frequency (RF) Exposure rules. This equipment should be installed and operated keeping the radiator at least 20 cm or more away from person's body (excluding extremities: hands, wrists, feet and ankles).

This device and its antenna(s) must not be co-located or operating with any other antenna or transmitter except Grant condition.

#### Compatible Wall-Mount Bracket Information

Use the following Sony Wall-Mount Bracket with your TV model.

TV Model No.	XR-75X90J / 75X90CJ / 65X90J / 65X90CJ / 55X90J / 55X90CJ
Wall-Mount Bracket Model No.	SU-WL855*1

Use with other Wall-Mount Brackets\*2 may cause instability and could result in property damage or injury.

- \*1 Only on limited region/country/TV model.
- \*2 For instructions on using the Wall-Mount Bracket (Wall-Mount Bracket not supplied) with your TV please contact a service center.

#### Before setting up your TV

Some TV models are packaged with a detached Table-Top Stand so you can mount your TV to a wall right away. See "Installing the TV to the Wall" if you want to mount the TV to a wall. If you are not mounting the TV to a wall, you will need to attach the Table-Top Stand.

- Be sure to consider the following while setting up your TV:
- Disconnect all cables when carrying the TV.
- Carry the TV with the adequate number of people; larger size TVs require two or more people (four or more people for XR-100X92).
- Correct hand placement while carrying the TV is very important for safety and to avoid damage.

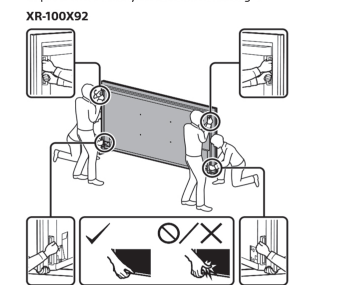

XR-75X90J / 75X90CJ / 65X90J / 65X90CJ / 55X90J / 55X90CJ / 50X90J

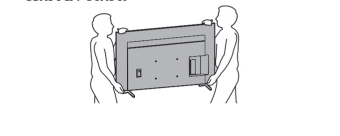

The cables mentioned in this guide is not supplied with your unit.

The image shown here is for illustrative purposes only and may be subject to change. The actual number of ports and their locations may vary depending on the model.

- Ensure your TV has adequate ventilation, refer to the safety documentation.
- For best picture quality, do not expose the screen to direct illumination or sunlight.
- Avoid installing the TV in a room with reflective wall and floor materials.
- Avoid moving the TV from a cold area to a warm area. Sudden room temperature changes may cause moisture condensation. This may cause the TV to show poor picture and/or poor color. Should this occur, allow moisture to evaporate completely before powering the TV on.

#### Securing the TV

Sony strongly recommends taking measures to prevent the TV from toppling over. Unsecured TVs may topple and result in property damage, serious bodily injury or even death.

#### Preventing the TV from Toppling

- Secure the TV to a wall and/or Stand.
- Do not allow children to play or climb on furniture and TV sets.
- Avoid placing or hanging items on the TV.
- Never install the TV on:
  - slippery, unstable and/or uneven surfaces.
  - furniture that can easily be used as steps, such as a chest of drawers.
- Install the TV where it cannot be pulled, pushed, or knocked over.
- Install the TV so that the TV's Table-Top Stand does not protrude out from the Stand (not supplied). If the Table-Top Stand protrudes out from the Stand, it may cause TV set to topple over, fall down, and cause personal injury or damage to the TV.



- Route all AC power cords and connecting cables so that they are not accessible to curious children.

#### Recommended Measures to Secure the TV

Consider the following measures when securing your TV to a Stand (not supplied).

- Secure the Stand for the TV. Make sure the Stand can adequately support the weight of the TV. Use two angle braces (not supplied) to secure the Stand. For each angle brace use the appropriate hardware to:
  - Attach one side of the angle brace to the wall stud.
  - Attach the other side to the Stand.

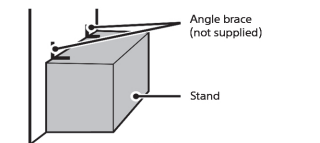

- Secure the TV to the Stand. Use the optional hardware listed as follows (not supplied):
  - M6 machine screws (screwed into the TV's Table-Top Stand) (XR-100X92 only).
  - M6 machine screws (screwed into the TV's rear cover) (Except XR-100X92).
  - A screw or similar (attach it to the Stand).
  - Rope or chain (strong enough to support the weight of the TV). Make sure that there is no excess slack in the rope or chain.

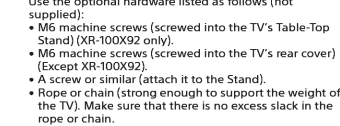

#### XR-100X92

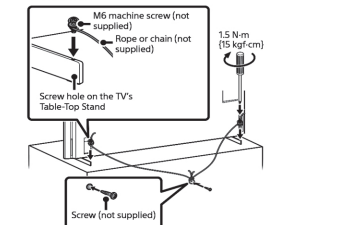

The length of the M6 machine screw differs depending on the rope or chain diameter. Please refer to below illustration.

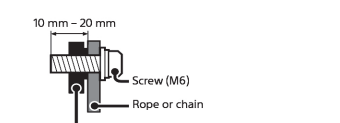

10 mm – 20 mm



#### XR-75X90J / 75X90CJ / 65X90J / 65X90CJ / 55X90J / 55X90CJ / 50X90J

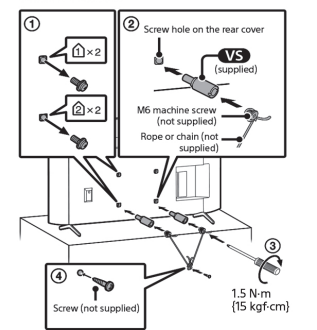

The length of the M6 machine screw differs depending on the rope or chain diameter. Please refer to below illustration.

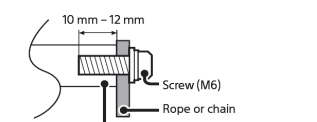

- Anchor the TV to the wall by using bolts, wall anchor and chain (or rope).

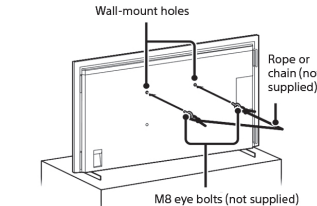
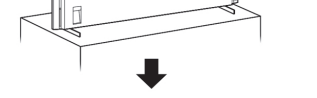
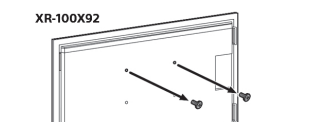

## Remote Control and TV

The remote control shape, layout, availability and function of remote control buttons may vary depending on your region/country/TV model/TV settings.

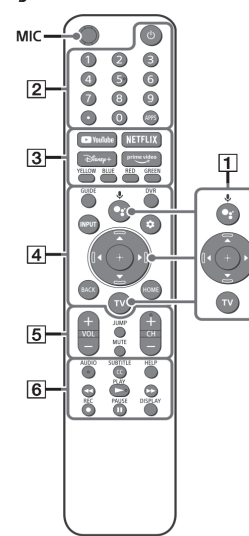

The remote control vary depend on model. The buttons on the remote control may have a different name or location than the remote control shows in this manual.

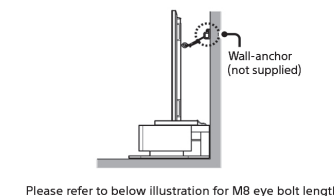

Please refer to below illustration for M8 eye bolt length.

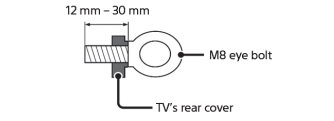

XR-75X90J / 75X90CJ / 65X90J / 65X90CJ / 55X90J / 55X90CJ / 50X90J

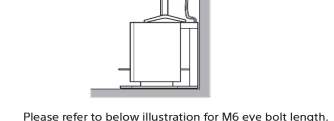
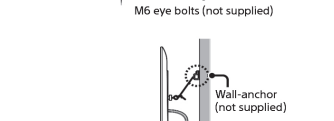
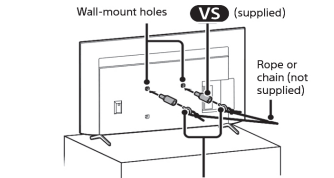

Please refer to below illustration for M6 eye bolt length.

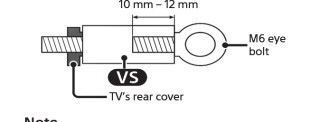

Note  
Your TV is shipped with screws attached to the rear of the TV depending on the TV model. (They are fastened in the screw holes for wall mounting.) Be sure to remove the upper two screws prior to anchoring the TV to a wall.  
Securing the TV to the Stand without securing the TV and the Stand to the wall provides minimum protection against the TV toppling over. For further protection, be sure to follow the three measures recommended.

- AUDIO:** Select the sound of multilingual source or dual sound (depend on program source).  
**SUBTITLE/CC**  
**HELP:** Display the Help menu.  
**◀/▶/▶/▶/II**  
● **REC:** Record the currently viewed program on DVR\*3.  
**DISPLAY:** Display information.

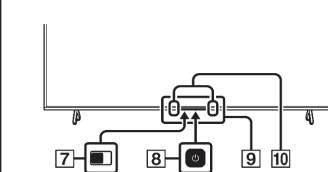

#### Guidelines for IR Remote Control

- Point your remote control directly at the IR sensor located on your TV.
- Make sure that no objects are blocking the path between the remote control and the IR sensor on your TV.

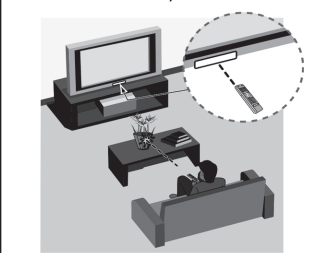

- Fluorescent lamps can interfere with your remote control; try turning off the fluorescent lamps.
- If you are having problems with the remote control, reinsert or replace your batteries and make sure that they are correctly inserted.

## Installing the TV to the Wall

Using the optional Wall-Mount Bracket (SU-WL855 only)\* (not supplied)

#### Wall-Mount Bracket Installation Information

For instructions on Wall-Mount Bracket installation, see the Installation Information (Wall-Mount Bracket not supplied) on the contact a service center

- Follow the instruction guide provided with the Wall-Mount Bracket for your model. Sufficient expertise is required in installing this TV, especially to determine the strength of the wall for withstanding the TV's weight.
- Sony is not liable for any damage or injury caused by mishandling or improper installation.
- The length of the screw for Wall-Mount Bracket differs depending on the Wall-Mount Bracket thickness. Please refer to below illustration.

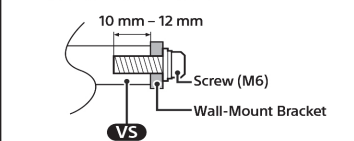

- Be sure to store the unused screws and Table-Top Stand in a safe place until you are ready to attach the Table-Top Stand. Keep the screws away from small children.

Note  
Read the supplied safety documentation for additional safety information.  
Only on limited region/country/TV model.

- BUILT-IN MIC SWITCH\*1:** Turn on/off the built-in MIC.
- (Power)**
- Remote Control sensor / Light sensor / LED**
- Built-in MIC\*1+2+5:** To enable the built-in MIC, press the Google Assistant button on the remote control and follow the on-screen instructions.

- Only on limited region/country/TV model/ language.
- Google Assistant requires an Internet connection.
- [Cable/Satellite box setup] setting is required.
- Accessibility shortcut is available by pressing and holding MUTE.
- Power consumption will increase when the built-in MIC is enabled as it is always listening.

#### Using the optional Wall-Mount Bracket (Except SU-WL855) (not supplied)

This TV's instruction manual only provides the steps to prepare the TV for Wall-Mount installation before it is installed on the wall.

Your TV can be mounted to a wall using a suitable Wall-Mount Bracket (not supplied). If the Table-Top Stand is attached to the TV, the TV may require detaching the Table-Top Stand; see "Detaching the Table-Top Stand from the TV". Prepare the TV for the Wall-Mount Bracket before making cable connections.

#### For product protection and safety reasons, Sony strongly recommends that installation of your TV on the wall be performed by qualified professionals. Do not attempt to install it yourself.

- Follow the instruction guide provided with the Wall-Mount Bracket for your model. Sufficient expertise is required in installing this TV, especially to determine the strength of the wall for withstanding the TV's weight.
- The screws for installing the Wall-Mount Bracket to the TV are not supplied.
- The length of the screw for Wall-Mount Bracket differs depending on the Wall-Mount Bracket thickness. Please refer to below illustration.

#### XR-100X92

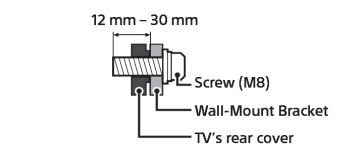

#### XR-75X90J / 75X90CJ / 65X90J / 65X90CJ / 55X90J / 55X90CJ / 50X90J

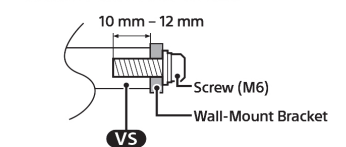

- Refer to the following table for wall-mount hole pattern.

Model Name	Wall-mount hole pattern
XR-100X92	600 × 400 mm
XR-75X90J / 75X90CJ	300 × 300 mm
XR-65X90J / 65X90CJ	300 × 300 mm
XR-55X90J / 55X90CJ	300 × 300 mm
XR-50X90J	200 × 200 mm

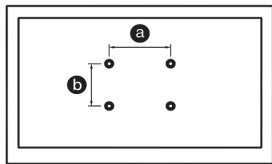

- Be sure to store the unused screws and Table-Top Stand in a safe place until you are ready to attach the Table-Top Stand. Keep the screws away from small children.

**Note**

- Read the supplied safety documentation for additional safety information.
- \* Only on limited region/country/TV model.

#### XR-100X92

##### 1 Remove the stand covers.

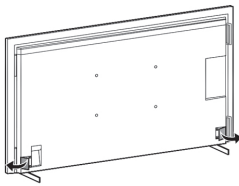

**Note**

- Read the supplied safety documentation for additional safety information.
- \* Only on limited region/country/TV model.

#### XR-100X92

##### 1 Remove the stand covers.

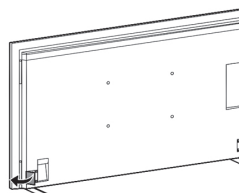

##### 2 Remove the screws from the rear of the TV.

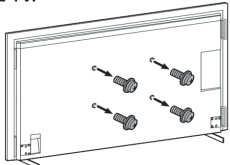

##### 3 Attach the Wall-Mount Bracket (not supplied) using the screws (not supplied).

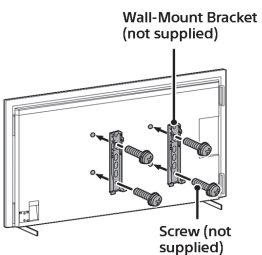

**Note**

- If using an electric screwdriver, set the torque at approximately 1.5 N·m [15 kgf·cm].

#### XR-75X90J / 75X90CJ / 65X90J / 65X90CJ / 55X90J / 55X90CJ / 50X90J

##### 1 Remove the screws from the rear of the TV.

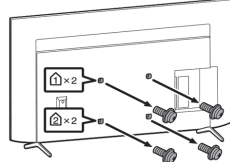

##### 2 Attach the Wall-Mount Attachment (supplied with the TV) to the rear of the TV (to make it parallel with the wall).

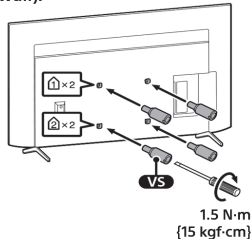

##### 3 Attach the Wall-Mount Bracket (not supplied) using the screws (not supplied).

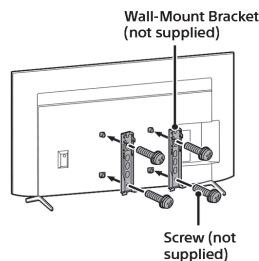

**Note**

- If using an electric screwdriver, set the torque at approximately 1.5 N·m [15 kgf·cm].
- Be sure to fasten the Wall-Mount Attachment when attaching them to the TV. Use only a flat head screwdriver to install the Wall-Mount Attachment. Use of another tool might result in over torquing the Wall-Mount Attachment and damaging the TV.

#### Detaching the Table-Top Stand from the TV

**XR-100X92**  
To detach the Table-Top Stand from the TV, remove the screws



**Note**

- Be careful when lifting the TV as the Table-Top Stand is detached, the Table-Top Stand may topple over and cause personal injury.
- Take care when removing the Table-Top Stand from the TV to prevent it from falling over and damaging the surface that the TV is sitting on.
- Do not remove the Table-Top Stand for any reason other than to install corresponding accessories on the TV.
- Be sure the TV is vertical before turning on. To avoid uneven picture uniformity do not power on the TV with the panel facing down.
- When attaching the Table-Top Stand again, be sure to fasten the screws (previously removed) to the original holes on the rear of the TV.

#### XR-75X90J / 75X90CJ / 65X90J / 65X90CJ / 55X90J / 55X90CJ / 50X90J

**1 Remove one side of the Table-Top Stand at a time. Firmly hold the Table-Top Stand securely with both hands while the other people lift up the TV.**



##### 2 Repeat the previous step and remove the other side of the Table-Top Stand.

**Note**

- Three or more people are required to detach the Table-Top Stand.
- Be careful not to use excessive force while detaching the Table-Top Stand from the TV as it may cause the TV set to fall resulting in personal injury or physical damage to the TV.
- Take care when handling the Table-Top Stand to prevent damage to the TV.
- Be careful when lifting the TV as the Table-Top Stand is detached, the Table-Top Stand may topple over and cause personal injury.
- Take care when removing the Table-Top Stand from the TV to prevent it from falling over and damaging the surface that the TV is sitting on.
- Do not remove the Table-Top Stand for any reason other than to install corresponding accessories on the TV.
- Be sure the TV is vertical before turning on. To avoid uneven picture uniformity do not power on the TV with the LCD panel facing down.

### Troubleshooting

General troubleshooting for issues like: black screen, no sound, frozen picture, TV does not respond, or network is lost, do the following steps.

**1** Restart your TV by pressing the power button on the remote control for about five seconds. The TV will restart. If the TV does not recover, try unplugging the AC power cord then press the power button on the TV and release it. Wait for two minutes, and plug in the AC power cord. Or, press the power button on the TV for about 40 seconds until the TV turns off.

**2** Refer to the Help menu by pressing **HELP** on the remote control.

**3** Connect your TV to the Internet and perform a software update. Sony recommends you to keep your TV software updated. Software updates provide new features and performance improvements.

**4** Perform the factory data reset.

**When you plug in the TV, the TV may not be able to turn on for a while even if you press the power button on the remote control or the TV.**  
It takes time to initialize the system. Wait for about one minute, then operate it again.

**How to reset the TV to factory settings**  
**WARNING:** The reset will clear all of your customized settings including the parental lock setting.

- You can reset the TV to factory settings by selecting [Factory data reset]. How to select [Factory data reset], refer to the online Help Guide.
- To force factory data reset, unplug the AC power cord. Press and hold button on the TV, then plug in the AC power cord.
- For security purposes, be sure to remove all personal and account information before discarding, selling or passing your TV to someone else by: unlinking/unregistering, signing out of and deactivating all network services as well as factory reset the TV.

**The remote control does not function.**

- Replace the batteries.

**The parental lock password has been forgotten.**

- Enter 4357 for the PIN and enter the new PIN.

**The restricted profile password has been forgotten.**

- Perform the force factory data reset.

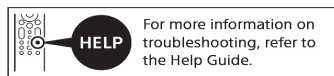

### Specifications

#### System

TV system: Depend on your country/area selection/TV model  
NTSC: American TV Standard  
ATSC (8VSB Terrestrial): ATSC compliant  
BVS  
NEXTGEN TV: ATSC 3.0 compliant (Single tuner)  
QAM on cable: ANSI/SCTE 07 2000 (Does not include CableCARD functionality)

Channel coverage: Depend on your country/area selection/TV model  
Analog terrestrial: 2 – 69 / Digital terrestrial: 2 – 69\*1  
Analog Cable: 1 – 135 / Digital Cable: 1 – 135

Panel system: LCD (Liquid Crystal Display) Panel, LED Backlight  
Speaker output: 10 W + 10 W  
Wireless technology  
Protocol IEEE 802.11a/b/g/n/ac  
Bluetooth® Version 4.2

#### Input/Output jacks

##### CABLE/ANTENNA

75 ohm external terminal for RF inputs

/ VIDEO IN

Video/Audio input (mini jack)

HDMI IN 1/2/3/4 (HDCP 2.3-compatible)

##### Video:

4096 × 2160p (60 Hz)<sup>2+3</sup>, 4096 × 2160p (24 Hz)<sup>2</sup>, 3840 × 2160p (60 Hz)<sup>3</sup>, 3840 × 2160p (24, 30 Hz), 1080p (30, 60, 120 Hz), 1080i/24p, 1080i (60 Hz), 720p (30, 60 Hz), 720/24p, 480p, PC Formats<sup>4</sup>

3840 × 2160p (120 Hz)<sup>3+5</sup>

##### Audio:

In eARC (Enhanced Audio Return Channel) mode

Refer to the online Help Guide for details.

Except eARC mode

5.1 channel linear PCM: 32/44.1/48/

88.2/96/176.4/192 kHz 16/20/24 bits,

Dolby Audio, Dolby Atmos, DTS

eARC/ARC (Enhanced Audio Return Channel/Audio Return Channel) (HDMI IN 3 only)<sup>6</sup>

In eARC mode

Refer to the online Help Guide for details.

In ARC mode

Two channel linear PCM: 48 kHz 16 bits,

Dolby Audio, Dolby Atmos, DTS

DIGITAL AUDIO OUT (OPTICAL)

Digital optical jack (Two channel linear PCM: 48 kHz 16 bits, Dolby Audio, DTS)

(Stereo mini jack)

Headphone

1, 2

USB port 1 supports High Speed USB (USB 2.0)

USB port 2 supports Super Speed USB (USB 3.1 Gen 1)

LAN

10BASE-T/100BASE-TX connector

(Depending on the operating environment of the network, connection speed may differ. The communication rate and quality are not guaranteed.)

Home Network supported files and formats<sup>4</sup>

#### REMOTE

RS-232C mini jack, IR IN mini jack

These jacks are for receiving the external control signal.

#### Power and others

Power requirements

110 V – 240 V AC, 50/60 Hz (U.S.A./

Canada 120 V AC, 60 Hz)

Power consumption

#### In use

XR-100X92: 426 W

XR-75X90J / 75X90CJ: 304 W

XR-65X90J / 65X90CJ: 240 W

XR-55X90J / 55X90CJ: 197 W

XR-50X90J: 159 W

In standby<sup>7,8</sup>

Less than 0.5 W with 120 V AC and less than 0.5 W with 240 V AC

Screen size (measured diagonally) (Approx.)

XR-100X92: 252.8 cm / 99.5 inches

(100" class)

XR-75X90J / 75X90CJ: 189.3 cm /

74.5 inches (75" class)

XR-65X90J / 65X90CJ: 163.9 cm /

64.5 inches (65" class)

XR-55X90J / 55X90CJ: 138.8 cm /

54.6 inches (55" class)

XR-50X90J: 125.7 cm / 49.5 inches

(50" class)

Display resolution (horizontal × vertical)

(pixels)

3840 × 2160

Output rating

500 mA (for USB 1), 900 mA (for USB 2)

**Dimensions (Approx.) (w × h × d) (mm) /**

**(inches)**

with stand

XR-100X92: 2260 × 1346 × 475 / 89 × 53 ×

18<sup>3</sup>/<sub>4</sub>

XR-75X90J / 75X90CJ: 1675 × 1040 × 410 /

66 × 41 × 16<sup>1</sup>/<sub>4</sub>

XR-65X90J / 65X90CJ: 1452 × 905 × 338 /

57<sup>1</sup>/<sub>4</sub> × 35<sup>3</sup>/<sub>4</sub> × 13<sup>3</sup>/<sub>8</sub>

XR-55X90J / 55X90CJ: 1233 × 784 × 338 /

48<sup>5</sup>/<sub>8</sub> × 30<sup>7</sup>/<sub>8</sub> × 13<sup>3</sup>/<sub>8</sub>

XR-50X90J: 1119 × 715 × 286 / 44<sup>1</sup>/<sub>8</sub> × 28<sup>1</sup>/<sub>4</sub> ×

11<sup>3</sup>/<sub>8</sub>

without stand

XR-100X92: 2260 × 1297 × 98 / 89 × 51<sup>1</sup>/<sub>8</sub> ×

3<sup>7</sup>/<sub>8</sub>

XR-75X90J / 75X90CJ: 1675 × 962 × 73 / 66 ×

37<sup>1</sup>/<sub>8</sub> × 2<sup>1</sup>/<sub>8</sub>

XR-65X90J / 65X90CJ: 1452 × 834 × 72 /

57<sup>1</sup>/<sub>4</sub> × 32<sup>1</sup>/<sub>8</sub> × 2<sup>1</sup>/<sub>8</sub>

XR-55X90J / 55X90CJ: 1233 × 711 × 72 /

48<sup>5</sup>/<sub>8</sub> × 28 × 2<sup>1</sup>/<sub>8</sub>

XR-50X90J: 1119 × 649 × 70 / 44<sup>1</sup>/<sub>8</sub> × 25<sup>5</sup>/<sub>8</sub> ×

2<sup>1</sup>/<sub>8</sub>

wall-mount hole pattern

XR-100X92: 600 × 400 mm

XR-75X90J / 75X90CJ: 300 × 300 mm

XR-65X90J / 65X90CJ: 300 × 300 mm

XR-55X90J / 55X90CJ: 300 × 300 mm

XR-50X90J: 200 × 200 mm

wall-mount screw size (mm)

XR-100X92: M8 (length: see "Installing the TV to the Wall".)

XR-75X90J / 75X90CJ / 65X90J / 65X90CJ /

55X90J / 55X90CJ / 50X90J: M6 (length: see "Installing the TV to the Wall".)

#### Mass (Approx.) (kg) / (lb.)

with stand

XR-100X92: 92.6 / 204

XR-75X90J / 75X90CJ: 34.5 / 76

XR-65X90J / 65X90CJ: 23.8 / 52.5

XR-55X90J / 55X90CJ: 18.3 / 40.4

XR-50X90J: 14.1 / 31.1

without stand

XR-100X92: 88.9 / 195.9

XR-75X90J / 75X90CJ: 33.3 / 73.4

XR-65X90J / 65X90CJ: 22.9 / 50.5

XR-55X90J / 55X90CJ: 17.4 / 38.4

XR-50X90J: 13.5 / 29.8

#### Others

Optional accessories

Wall-Mount Bracket: SU-WL855

(XR-75X90J / 75X90CJ / 65X90J / 65X90CJ / 55X90J / 55X90CJ only)

Operating temperature: 0 °C – 40 °C /

32 °F – 104 °F

\*1 2 – 36 for NEXTGEN TV scanning range in U.S.A.

\*2 When 4096 × 2160p is input and [Wide mode]

is set to [Normal], the resolution is displayed as

3840 × 2160p. To display 4096 × 2160p, set

[Wide mode] setting to [Full 1] or [Full 2].

\*3 Refer to the on screen menu to set [HDMI

signal format].

\*4 Refer to the online Help Guide for details.

\*5 HDMI IN 3 & 4 only. Use the Ultra High Speed

HDMI Cable to connect.

\*6 Connect your audio system to the HDMI IN 3 to

route TV audio to your audio system.

\*7 Specified standby power is reached after the

TV finishes necessary internal processes.

\*8 Standby power consumption will increase

when your TV is connected to the network.

**Note**

- Optional accessories availability depends on countries/region/TV model/stock.
- Design and specifications are subject to change without notice.
- Subscriptions for services and applications may be required and additional terms, conditions and/or charges may apply when using Google Assistant.

#### Licensing Information

- The terms HDMI, HDMI High-Definition Multimedia Interface, and the HDMI Logo are trademarks or registered trademarks of HDMI Licensing Administrator, Inc.
- Dolby, Dolby Vision, Dolby Atmos, Dolby Audio, and the double-D symbol are trademarks of Dolby Laboratories Licensing Corporation. Manufactured under license from Dolby Laboratories. Confidential unpublished works. Copyright © 1992-2020 Dolby Laboratories. All rights reserved.
- Gracenote, the Gracenote logo and logotype, "Powered by Gracenote" logo are either registered trademarks or trademarks of Gracenote, Inc. in the United States and/or other countries.
- Google TV and related logos are trademarks of Google LLC.

- For DTS patents, see <http://patents.dts.com>. Manufactured under license from DTS, Inc. DTS, Digital Surround, and the DTS logo are registered trademarks or trademarks of DTS, Inc. in the United States and other countries. © 2020 DTS, Inc. ALL RIGHTS RESERVED.
- Netflix is a registered trademark of Netflix, Inc.
- TUXERA is a registered trademark of Tuxera Inc. in the US and other countries.
- All other trademarks are the property of their respective owners.

### REFURBISHED PRODUCT LIMITED NINETY DAYS WARRANTY

The **Refurbished Product Service Center** offers the following WARRANTY to the ORIGINAL purchaser of a product which we have refurbished.

This product that has been refurbished is warranted against any electronic or mechanical defects for a period of NINETY DAYS from the date of the original purchase by the consumer. Since this unit was sold as a refurbished item, the warranty does not apply to any cosmetic appearance items such as scratches. Should a defect occur, the **Refurbished Product Service Center** will repair or, at its option, replace defective unit/parts with new or rebuilt materials without charge for either parts or labor. Replacement unit/parts will be warranted for the remaining portion of the original warranty period.

This warranty does not cover installation or damage from accident, misuse, abuse, improper wiring, incorrect voltage, operating the unit against the instructions in the owner's manual or any product which has been opened, altered, or tampered with.

This warranty does not cover costs for removal and or installation of the unit for repair. Under no circumstances shall the service center be liable for any special, incidental or consequential damages or for any other expenses incurred by reason of use or sale of this product. This warranty is in lieu of any other warranties expressed or implied warranty of merchantability of fitness for particular use or otherwise.

This warranty gives the consumer specific legal rights and they may also have other rights which vary from State

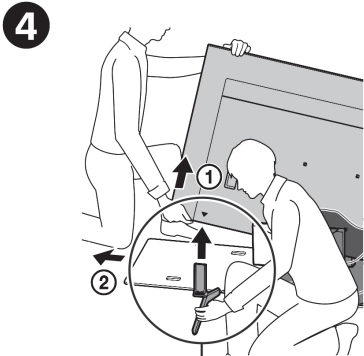
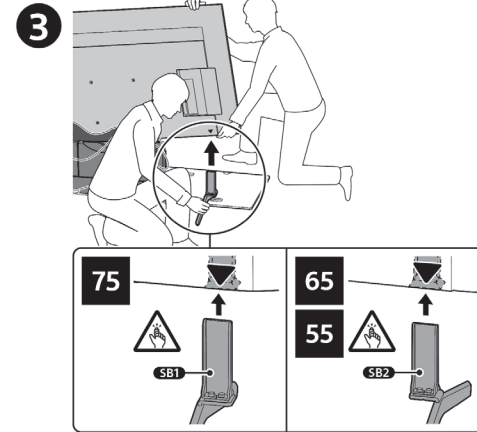
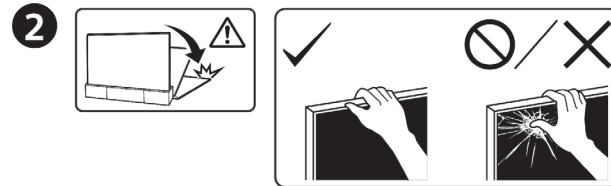
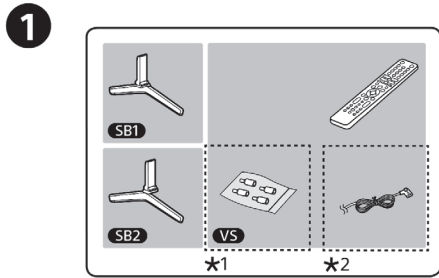
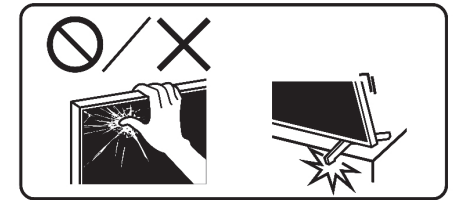

**5**

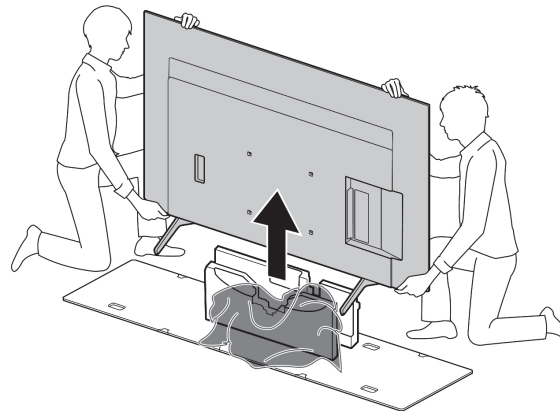

The remote control vary depend of model: The buttons on the remote control may have a different name or location than the remote control shows in this manual.

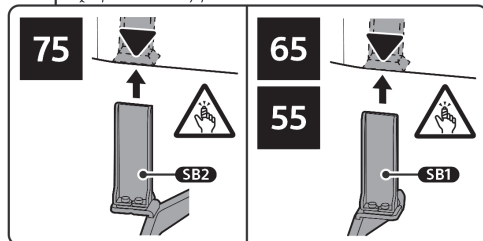

\*1 Refer Reference Guide

\*2 Only on limited region/country/TV model.

6

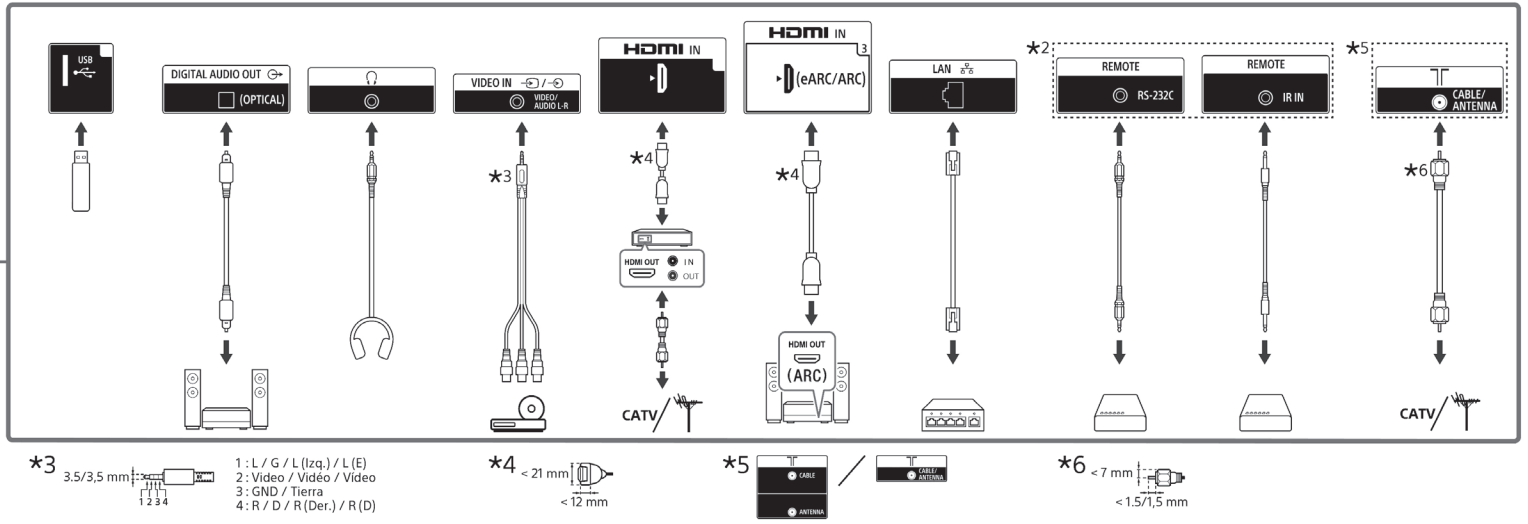
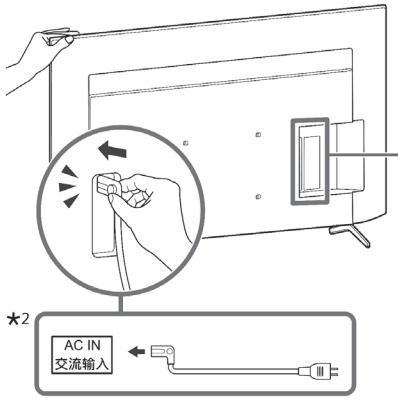

The cables mentioned in this guide is not supplied with your unit.

7

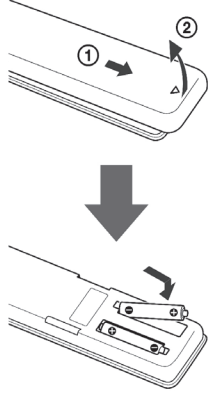

(Batteries not supplied)

8

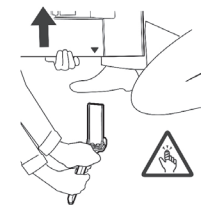
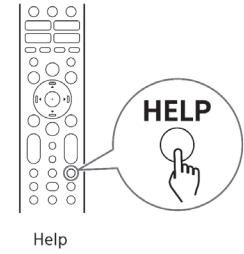
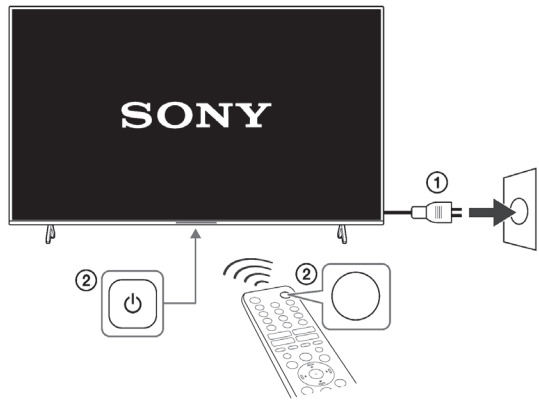

The image shown here is for illustrative purposes only and may be subject to change. The actual number of ports and their locations may vary depending on the model.



804006587

PRINTED IN MEXICO

Elbrd: J.E.

OBNP: \*5024944111\*

SC: 06-10-2021\_2P

MODEL: XR75X90CJ\_BP