

NOTE: The dehumidifier has rollers to aid placement, but it should only be rolled on smooth, flat surfaces. Do not attempt to roll the dehumidifier on carpet or over objects.

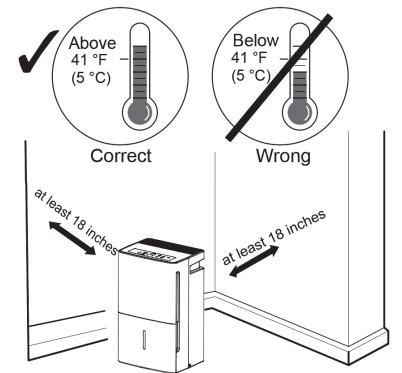

Using the Dehumidifier - Cont.

Always make sure the water bucket is locked into place on the dehumidifier.

Removing Collected Water

There are 2 ways to remove collected water:

Use the bucket. When the bucket is removed, the unit will shut off. Empty and replace the bucket.

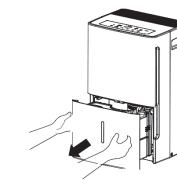

3. Thread a garden hose (not supplied) onto the nozzle, cut to length, and lead it to the floor drain.

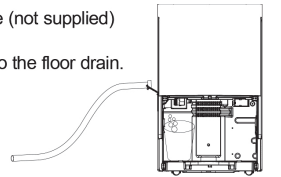

4. Replace the bucket in the unit.

NOTE: The bucket must be in place and securely seated for the dehumidifier to operate.

IMPORTANT: Do not use the hose if using the bucket to collect water. When the hose is connected, water will flow through it onto the floor instead of into the bucket.

NOTES:

- Do not remove the bucket while the dehumidifier is operating or if it has just stopped operating. cause some water to drip from the drain pan.
- The bucket must be in place and securely seated for the dehumidifier to operate.

Use a hose. Water can be automatically emptied into a floor drain by attaching a garden water hose (not included).

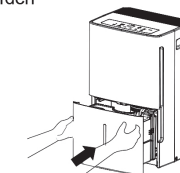

- Remove the bucket from the front of the unit.
- Open the drain cover on the side of the unit.

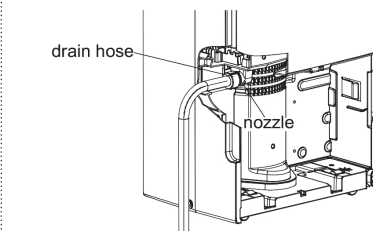

Water Level

The dehumidifier will turn off automatically when the bucket is full, or when the bucket is removed or not replaced in the proper position.

The bucket must be replaced in the proper position for the dehumidifier to work. The bucket full light will be on and the dehumidifier will not run if the bucket is not in the proper position.

Bucket Operation

DO NOT remove the foam piece in the bucket assembly. If removed the Dehumidifier will not work properly.

When the coil is defrosted, the compressor or fan will automatically restart and dehumidifying will resume.

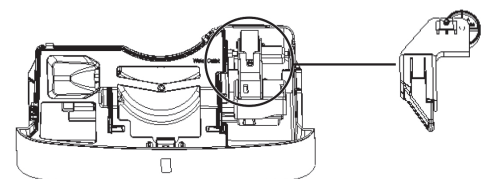

IMPORTANT SAFETY INFORMATION
READ ALL INSTRUCTIONS BEFORE USING THE APPLIANCE

WARNING For your safety, the information in this manual must be followed to minimize the risk of fire, electric shock or personal injury.

- Use this appliance only for its intended purpose as described in this Owner's Manual.
- This dehumidifier must be properly installed and grounded as described in this manual before it is used.
- Never operate this dehumidifier in an area that is likely to accumulate standing water. If this condition develops, for your safety disconnect the power supply before stepping into the water.
- Never unplug your dehumidifier by pulling on the power cord. Always grip plug firmly and pull straight out from the receptacle.
- Replace immediately all electric service cords that have become frayed or otherwise damaged. A damaged power supply cord must be replaced with a new power supply cord obtained from the manufacturer and not repaired. Do not use a cord that shows cracks or abrasion damage along its length or at either the plug or connector end.
- If the receptacle does not match the plug, the receptacle must be changed out by a qualified electrician
- If the SUPPLY CORD is damaged, it must be replaced by the manufacturer, its service agent or similarly qualified person in order to avoid a hazard.
- The appliance shall be installed in accordance with national wiring regulations.
- Turn the dehumidifier OFF and unplug it before cleaning.
- GE Appliances does not support any servicing of the dehumidifier. We strongly recommend that you do not attempt to service the dehumidifier yourself.
- For your safety, do not store or use combustible materials, gasoline or other flammable vapors or liquids in the vicinity of this or any other appliance.
- All dehumidifiers contain refrigerants, which under federal law must be removed prior to product disposal. If you are getting rid of an old product with refrigerants, check with the company handling disposal about what to do.
- Do not use outdoors.
- This dehumidifier is intended for indoor residential applications only. This dehumidifier should not be used for commercial or industrial applications.
- These R410A Dehumidifier Systems require contractors and technicians to use tools, equipment and safety standards approved for use with this refrigerant. DO NOT use equipment certified for R22 refrigerant only.
- This appliance can be used by persons with reduced physical, sensory or mental capabilities or lack of experience and knowledge if they have been given supervision or instruction concerning use of the appliance in a safe way and understand the hazards involved.

WARNING USE OF EXTENSION CORDS

- RISK OF FIRE. Could cause serious injury or death.**
- DO NOT use an extension cord with this Dehumidifier.
 - DO NOT use surge protectors or multi-outlet adaptors with this Dehumidifier.

HOW TO CONNECT ELECTRICITY

Do not, under any circumstances, cut or remove the third (ground) prong from the power cord. For personal safety, this appliance must be properly grounded.

DO NOT use an adapter plug with this appliance.

The power cord of this appliance is equipped with a 3-prong (grounding) plug which mates with a standard 3-prong (grounding) wall outlet to minimize the possibility of electric shock hazard from this appliance.

Have the wall outlet and circuit checked by a qualified electrician to make sure the outlet is properly grounded.

Where a 2-prong wall outlet is encountered, it is your personal responsibility and obligation to have it replaced with a properly grounded 3-prong wall outlet.

The dehumidifier should always be plugged into its own individual electrical outlet, which has a voltage rating matching the rating plate.

This provides the best performance and also prevents overloading house wiring circuits, which could cause a fire hazard from overheated wires.

RECYCLING INFORMATION

For appliance recycling information please visit www.geappliances.com/recycling.

READ AND SAVE THESE INSTRUCTIONS

Controls

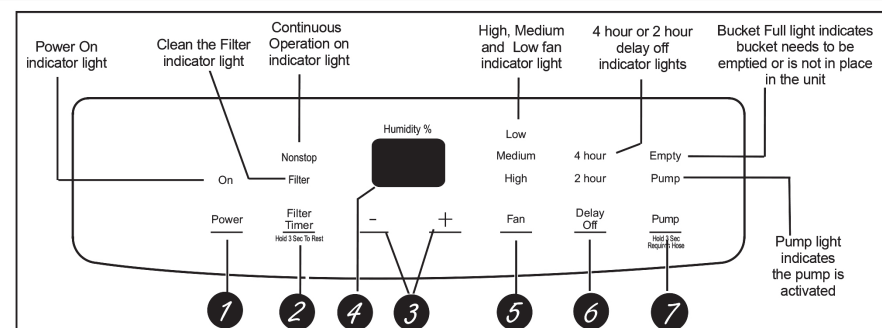

Note: The images shown here are for illustrative purpose only and may be subject to change.

Controls

NOTE: When the bucket is full or removed, the controls cannot be set.

- Power Pad**
Press to turn the dehumidifier on and off.
- Filter Timer**
After 250 hours of operation, the Clean the Filter indicator light will glow to remind you to clean the filter. Remove the filter and clean it.
Press to turn off the Clean the Filter light. See the Care and Cleaning section.
- Humidity Set Control Pads**
The humidity level can be set within a range of 35% RH (Relative Humidity) to 80% RH (Relative Humidity) in 5% increments or at NS for continuous operation. To set the unit for continuous operation, press the - pad until the screen reads NS.
NOTE: If NS (Nonstop) is selected, the dehumidifier will operate continuously at its maximum dehumidification settings if attached to a hose to drain or until the bucket is full.
For drier air, press the - pad and set to a lower percent value (%).
For damper air, press the + pad and set to a higher percent value (%).

When you first use the dehumidifier, set the humidity control to 45% or 50%. Allow at least 24 hours for the dehumidifier to achieve the humidity level. If you still have damper air than desired, set the humidity level to a lower setting or select Nonstop for maximum dehumidification.

- Display**
Shows the set % humidity level while setting, then shows the actual (+/- 5% accuracy) room % humidity level.
- Fan Speed Pad**
Controls the fan speed.
Press to select either High, Medium or Low fan speed.
Set the fan control to High for maximum moisture removal. When the humidity has been reduced and quiet operation is preferred, set the fan control to Medium or Low.
- Delay Off**
While the dehumidifier is in operation, press this pad to set it to automatically turn off in 2 hours or 4 hours.
- Pump**
Activates the internal pump function. Press for 3 seconds to activate the internal pump for automatic removal of condensate. The internal pump indicator light will remain illuminated after 3 seconds. Press to deactivate the pump.

Other Features

Empty Light
Glows when the bucket is ready to be emptied, or when the bucket is removed or not replaced in the proper position.

Alarm
If the bucket is full or missing for more than 3 minutes, an alarm will sound for about 10 seconds to remind you to empty and replace the bucket.

Auto Shut Off
The Water Level Control Switch shuts off the dehumidifier when the bucket is full, or when the bucket is removed

or not replaced in the proper position. **NOTE:** Fan will continue to run approximately 3 minutes after bucket is removed.

Auto Defrost
When frost builds up on the evaporator coils, the compressor will cycle off and the fan will continue to run until the frost disappears.

Power Outage
In the case of a power outage or interruption, the unit will automatically restart, in the settings last used, after the power is restored.

Using the Dehumidifier

When first using the dehumidifier, operate the unit continuously for 24 hours.

How the Dehumidifier Operates

Moist, humid air is drawn over a cold refrigerated dehumidifying coil. Moisture in the air condenses on this coil and drains into a bucket (or through a hose and drain).

Dry, clean air is drawn through the condenser where it is heated and discharged out the top grille into the room.

It is normal for the surrounding air to become slightly warmer as the dehumidifier operates.

Automatic Defrost

When frost builds up on the evaporator coils, the compressor will cycle off and the fan will continue to run until the frost disappears.

When the coil is defrosted, the compressor or fan will automatically restart and dehumidifying will resume.

Choosing a Location

A dehumidifier operating in a basement will have little or no effect in drying an adjacent enclosed storage area, such as a closet, unless there is adequate circulation of air in and out of the area.

- Do not use outdoors.
- This dehumidifier is intended for indoor residential applications only. This dehumidifier should not be used for commercial or industrial applications.
- Place the dehumidifier on a smooth, level floor strong enough to support the unit with a full bucket of water.
- Allow at least 18 inches of air space on all sides of the unit for good air circulation.
- Place the dehumidifier in an area where the temperature will not fall below 41°F (5°C) or above 90°F (32°C). The coils can become covered with frost at temperatures below 41°F, which may reduce performance.
- The suggested range of relative humidity is between 30% and 90%
- Use the dehumidifier in cooking, laundry, bathing and dishwashing areas that have excessive moisture.
NOTE: Place the dehumidifier away from the clothes dryer.
- Use the dehumidifier to prevent moisture damage anywhere books or valuables are stored.
- Use the dehumidifier in a basement to help prevent moisture damage.
- The dehumidifier must be operated in an enclosed area to be most effective.
- Close all doors, windows and other outside openings to the room.

Care and Cleaning

Turn off the dehumidifier and remove the plug from the wall outlet before cleaning.

Grille and Case

To clean the case:

Use water and a mild detergent. Do not use bleach or abrasives.

To clean the front grille:

Use a vacuum attachment or brush.

Water Bucket

To clean:

Every few weeks, clean the bucket to prevent growth of mold, mildew and bacteria. Partially fill the bucket with clean water and add a little mild detergent. Swish it around in the bucket, empty and rinse.

NOTE: Do not use a dishwasher to clean the water bucket.

To remove:

Remove the bucket and pour out any water.

To replace:

Slide the bucket into the dehumidifier.

NOTE: The bucket must be in place and securely seated for the dehumidifier to operate.

Air Filter

The air filter behind the front grille should be checked and cleaned at least every 250 hours of operation or more often if necessary.

After 250 hours of operation, the Clean the Filter indicator light will glow to remind you to clean the filter. Remove the filter and clean it. Replace the filter and press the Filter Timer pad to turn off the Clean the Filter light.

To remove:

Remove the bucket. Grasp the filter edge, and pull it straight down and out.

To clean:

Clean the filter with warm, soapy water. Rinse and let the filter dry before replacing it.

NOTE: DO NOT put the filter in an automatic dishwasher.

CAUTION DO NOT operate the dehumidifier without a filter because dirt and lint will clog it and reduce performance.

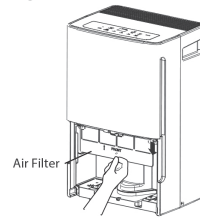

Bucket Filter

The bucket filter is located inside the bucket near the bottom. The filter should be checked when cleaning the bucket. If the filter has any debris on it, gently remove the filter as described below and rinse with warm water. Replace the filter in the bucket once it is clean.

TO REMOVE THE FILTER:

1. Squeeze both clasp inward to disengage clasp clips from water tank cover. Lift the cover upwards to remove.

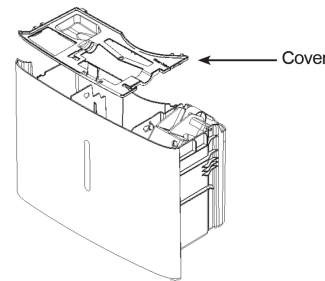

TO REPLACE THE FILTER:

3. Place large end of filter above tabs, press filter down firmly to spread tabs. Once filter is between tabs press filter inward to engage tabs into filter.
4. Replace water tank cover and handle.

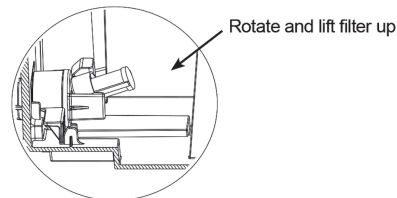

IMPORTANT: Be careful not to tear or damage filter during removal, cleaning or replacement. Do not use the dishwasher to clean the filter.

Storage

If the unit is to be stored for an extended period of time, take the following actions before putting away the machine.

1. Empty the bucket of all water.
2. Clean the water bucket and bucket filter per instructions.
3. Allow water bucket to dry and reinstall.

Electric Schematic Diagram

The electric schematic diagram is subject to change without notice.

Please refer to the correct one on the unit.

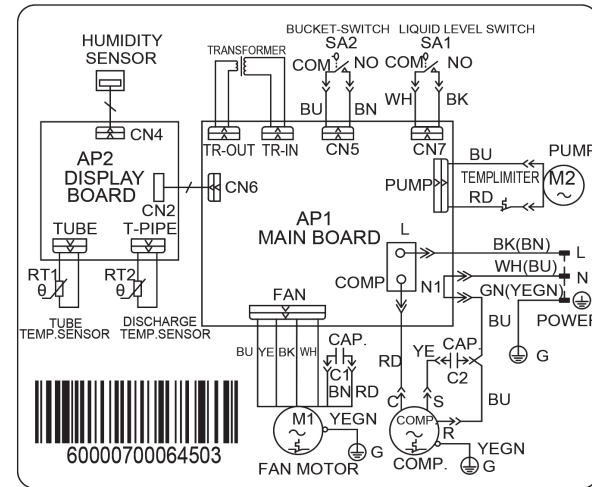

Troubleshooting Tips... Before you call for service

Save time and money! Review the charts on the following pages first and you may not need to call for service.

Problem	Possible Cause	What To Do
Dehumidifier does not start	The dehumidifier is unplugged.	Makes sure the dehumidifier's plug is pushed completely into the outlet.
	The fuse is blown/circuit breaker is tripped.	Check the house fuse/circuit breaker box and replace the fuse or reset the breaker.
	Dehumidifier has reached its preset level or bucket is full.	The dehumidifier automatically turns off when either condition occurs. Change to a lower setting or empty the bucket and replace properly.
	Bucket is not in the proper position.	The bucket must be in place and securely seated for the dehumidifier to operate.
	Power Failure.	There is a protective time delay (up to 3 minutes) to prevent tripping of the compressor overload. For this reason, the unit may not start normal dehumidification for 3 minutes after turning back on.
Dehumidifier does not dry the air as it should	Did not allow enough time to remove the moisture.	When first installed, allow at least 24 hours to maintain the desired dryness.
	Airflow is restricted.	Make sure there are no curtains, blinds or furniture blocking the front of back of the dehumidifier. See the Choosing a Location section.
	Dirty Filter	See the Care and Cleaning section.
	The Humidity Control may not be set low enough.	For drier air, press the - pad and set to a lower percent value (%) or at NS (Nonstop) for maximum dehumidification.
	Doors and windows may not be closed tightly.	Check that all doors, windows and other openings are securely closed.
	Clothes dryer may be blowing moisture-laden air into the room.	Install the dehumidifier away from the dryer. The dryer should be vented to the outside.
Room temperature is too low.	Moisture removal is best at higher room temperatures. Lower room temperatures will reduce the moisture removal rate. Models are designed to be operated at temperatures above 41°F (5°C).	
Dehumidifier runs too much	Area to be dehumidified is too large.	The capacity of your dehumidifier may not be adequate.
	Doors and windows are open.	Close all doors and windows to the outside.
Frost appears on the coils	Dehumidifier has been turned on recently, or room temperature is below 41°F (5°C)	This is normal. Frost will usually disappear within 60 minutes. See the Automatic Defrost section
Control cannot be set	The compressor will turn off and the fan will automatically continue to run for approximately 3 minutes at a fixed setting.	This is normal. Wait approximately 3 minutes and set the fan as desired.
Fan noise	Air is moving through the dehumidifier.	This is normal.
Water on floor	Hose connection may be loose.	Check the hose connection. See the Removing Collected Water section.
	Intended to use the bucket to collect water, but a hose was attached.	Disconnect the hose if using a bucket to collect water. See the Removing Collected Water section.
Bucket Full LED light flashing and alarm sounds while drain hose is connected.	Drain hose not tight on fitting.	Check drain hose connection.
	Drain hose is kinked.	Ensure the drain hose is pointed straight down to the floor and is not kinked in anyway.

REFURBISHED PRODUCT LIMITED THIRTY DAY WARRANTY

The **Refurbished Product Service Center** offers the following WARRANTY to the ORIGINAL purchaser of a product which we have refurbished.

This product that has been refurbished is warranted against any electronic or mechanical defects for a period of THIRTY DAYS from the date of the original purchase by the consumer. Since this unit was sold as a refurbished item, the warranty does not apply to any cosmetic appearance items such as scratches. Should a defect occur, the **Refurbished Product Service Center** will repair or, at its option, replace defective unit/parts with new or rebuilt materials without charge for either parts or labor. Replacement unit/parts will be warranted for the remaining portion of the original warranty period.

This warranty does not cover installation or damage from accident, misuse, abuse, improper wiring, incorrect voltage, operating the unit against the instructions in the owner's manual or any product which has been opened, altered, or tampered with.

This warranty does not cover costs for removal and or installation of the unit for repair. Under no circumstances shall the service center be liable for any special, incidental or consequential damages or for any other expenses incurred by reason of use or sale of this product. This warranty is in lieu of any other warranties expressed or implied warranty of merchantability of fitness for particular use or otherwise.

This warranty gives the consumer specific legal rights and they may also have other rights which vary from State to State. Some States do not follow the exclusion or limitation of incidental or consequential damages, hence the above exclusion and limitations may not apply.

Refurbished Product Service Center
13225 Marquardt Avenue Santa Fe Springs, CA 90670

WARRANTY REPAIR INFORMATION

If you need service on your unit during the 30 day warranty period; please go to www.ConsumerServiceRefurbish.com or call the Refurbished Product Service Center at 562-946-3531 to obtain the required claim number. Once you obtain your claim number, pack the unit properly (the original carton is ideal for this purpose) along with a copy of your purchase receipt. Send the unit freight prepaid and insured to:

Refurbished Product Service Center,
Att: Customer Service Department 13225 Marquardt Avenue Santa Fe Springs, CA 90670

Your unit will be promptly exchanged and returned to you. We will refuse to accept delivery of the returned unit unless the assigned claim number appears on the outside of the shipping carton.

Owner's Information
(Keep for your permanent records)

NAME: _____

ADDRESS: _____

CITY: _____ STATE: _____ ZIP CODE: _____

PHONE: _____ E-MAIL: _____

MODEL: _____ SERIAL NO.: _____



804109920A

PRINTED IN MEXICO Elbrd: Y.T.
OBPN: 49-5000427 Rev. 0 10-19 GEA
SC: 15-09-2020_TAB Rev2. 23-11-21_RMVDRNHS_M.C

