

# Shark VERTEX™

## DuoClean® PowerFins Powered Lift-Away® with Self-Cleaning Brushroll Upright Vacuum

### OWNER'S GUIDE

DUOclean POWERFINS

It's important to read this manual prior to using your product for the first time.

814100021

## IMPORTANT SAFETY INSTRUCTIONS FOR HOUSEHOLD USE ONLY

### WARNING

To reduce the risk of fire, electric shock, injury, or property damage, when using an electrical appliance, basic precautions should always be followed, including the following:

#### READ ALL INSTRUCTIONS BEFORE USING THIS VACUUM

1. Inspect power cord and plug for any damage before use. **DO NOT** use vacuum cleaner with a damaged cord or plug. Turn off all controls before plugging in or unplugging the vacuum cleaner. Store your vacuum cleaner with the power cord secured around the two cord hooks. To minimize the risk of power cord damage, do not allow the motorized brush roll to ingest the cord. If this occurs, immediately shut off power to the vacuum and remove the cord.
2. This appliance has a polarized plug, if the plug does not fit fully into the outlet, reverse the plug (one blade is wider than the other). If it still does not fit, contact a qualified electrician. **DO NOT** force into outlet or try to modify to fit.
3. Your vacuum cleaner may consist of a motorized nozzle, wand, hose, and/or vacuum pod. This device contains electrical connections, electrical wiring, and moving parts that potentially present risk to the user.
4. Use only identical replacement parts.
5. Carefully observe and follow the instructions provided below to avoid improper use of the appliance. **DO NOT** use the vacuum for any purpose other than those described in this manual.
6. Before use, carefully inspect all parts for any damage. **DO NOT** use if any parts are damaged.
7. The use of an extension cord is **NOT** recommended.
8. This vacuum cleaner contains no serviceable parts.
9. This appliance can be used by persons with reduced physical, sensory or mental capabilities or lack of experience and knowledge if they have been given supervision or instruction concerning use of the appliance in a safe way and understand the hazards involved. Cleaning and user maintenance shall not be made by children. Keep the appliance and its cord out of reach of children. **DO NOT** allow the appliance to be used by children. **DO NOT** allow to be used as a toy. Close supervision is necessary when used near children.
10. Always turn off the vacuum cleaner before connecting or disconnecting any motorized nozzles or other accessories.
11. **DO NOT** handle plug or vacuum cleaner with wet hands.
12. **DO NOT** use without filters in place.
13. Only use Shark® branded filters and accessories.
14. **DO NOT** damage the power cord:
  - a) **DO NOT** pull or carry vacuum cleaner by the cord or use the cord as a handle.
  - b) **DO NOT** unplug by pulling on cord. Grasp the plug, not the cord.
  - c) **DO NOT** run the vacuum cleaner over the power cord, close a door on the cord, pull the cord around sharp corners, or leave the cord near heated surfaces.
15. **DO NOT** put any objects into nozzle or accessory openings. **DO NOT** use with any opening blocked; keep free of dust, lint, hair, and anything that may reduce airflow.
16. **DO NOT** use if nozzle or accessory airflow is restricted. If the air paths or the motorized floor nozzle become blocked, turn the vacuum cleaner

off and unplug from electrical outlet. Remove all obstructions before you plug in and turn on the unit again.

17. Keep nozzle and all vacuum openings away from hair, face, fingers, uncovered feet, or loose clothing.
18. **DO NOT** use if vacuum cleaner is not working as it should, or has been dropped, damaged, left outdoors, or dropped into water.
19. Use extra care when cleaning on stairs.
20. **DO NOT** leave the vacuum cleaner unattended while plugged in.
21. When powered on, keep the vacuum cleaner moving over the carpet surface at all times to avoid damaging the carpet fibers.
22. **DO NOT** place vacuum cleaner on unstable surfaces such as chairs or tables.
23. Your Shark® vacuum may not be designed to stand up on its own. When taking a break from cleaning, you may need to lean it against furniture or a wall, or lay it flat on the floor. Using the vacuum for an application where the unit lacks stability may result in personal injury.
24. **DO NOT** use to pick up:
  - a) Liquids
  - b) Large objects
  - c) Hard or sharp objects (glass, nails, screws, or coins)
  - d) Large quantities of dust (drywall dust, fireplace ash, or embers). **DO NOT** use as an attachment to power tools for dust collection.
  - e) Smoking or burning objects (hot coals, cigarette butts, or matches)
  - f) Flammable or combustible materials (lighter fluid, gasoline, or kerosene)
  - g) Toxic materials (chlorine bleach, ammonia, or drain cleaner)
25. **DO NOT** use in the following areas:
  - a) Poorly lit areas
  - b) Wet or damp surfaces
  - c) Outdoor areas
  - d) Spaces that are enclosed and may contain explosive or toxic fumes or vapors (lighter fluid, gasoline, kerosene, paint, paint thinners, mothproofing substances, or flammable dust)
26. Turn off all controls before plugging in or unplugging the vacuum.
27. Unplug from electrical outlet when not in use and before any maintenance or cleaning.
28. Hand wash with water only. Washing with cleaning chemicals could damage the unit.
29. During cleaning or routine maintenance, **DO NOT** cut anything other than hair, fibers, or string wrapped around the brushroll.
30. Allow all filters to air-dry completely before replacing in the vacuum to prevent liquid from being drawn into electric parts.
31. Make sure the dust cup and all filters are in place after routine maintenance.
32. If provided, secure the power cord around the two cord hooks during storage.

#### TECHNICAL SPECIFICATIONS

Voltage: 120V~, 60Hz

### ASSEMBLY

1. Place motorized **Nozzle** on floor and insert **Wand**, pressing it in until it clicks securely into place.
  2. Place **Pod** onto wand and slide down to connect.
  3. Insert **Handle** into wand, pressing it in until it clicks securely into place.
  4. Connect **Hose** to back of pod, pressing it in until it clicks securely into place.
- IMPORTANT:** For proper operation, ensure all connections are securely clicked into place.

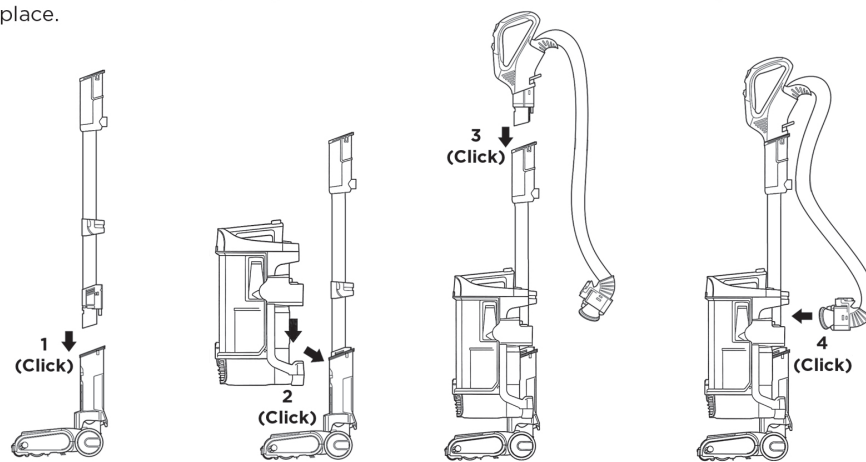

**NOTE:** Accessories may vary depending on the model. Refer to quick guide, if available. The images shown here are for illustrative purposes only and may be subject to change.

### WHOLE-HOME CLEANING

#### SETTINGS

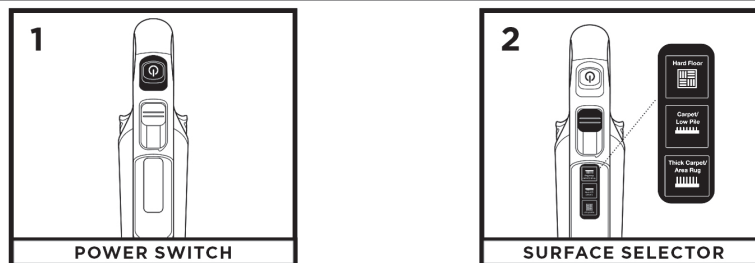

1. Press power button to turn on vacuum. Please note the brushrolls will not spin unless the wand is reclined.
2. **Thick Carpet & Area Rug Cleaning** — Slide the surface switch to the top position to select Thick Carpet/Area Rug. **Carpet & Low Pile Cleaning** — Slide the surface switch to the middle position to select Carpet/Low Pile to increase the speed of the brushrolls and to help remove stuck-on dust and debris. **Hard Floor Cleaning** — Slide the surface switch to the bottom position to select Hard Floor.

**NOTE:** Try using Hard Floor mode for low pile area rugs.

#### BRUSHROLL INDICATOR LIGHT

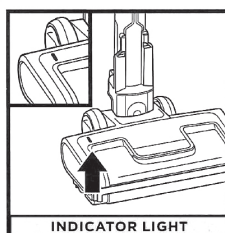

#### WHAT DOES THE BRUSHROLL INDICATOR LIGHT MEAN?

**Solid Green:** The brushrolls are spinning and working as they should.

**Solid Red:** There is a jam in the brushroll area. Turn off the vacuum and unplug it, then remove any blockages in the nozzle.

**Flashing Green:** The vacuum is operating in an environment that is either too hot or too cold. This vacuum will only function properly in temperatures

ranging from 32°F (0°C) to 104°F (40°C). Turn the vacuum off and adjust the room temperature. Once the temperature has reached the operating range, turn the vacuum back on.

**Flashing Red:** The motorized floor nozzle is overheating. Turn off the vacuum, unplug it, and remove any blockages. Let the vacuum cool down for at least 60 minutes before restarting. See Troubleshooting section for more information.

**NOTE:** For deep cleaning per ASTM F 608 (embedded dirt in carpets) please set to **Carpet/Low Pile**.

**NOTE:** For maximum suction for above-floor cleaning per ASTM F558, set to **Hard Floor** mode.

### CLEANING MODES

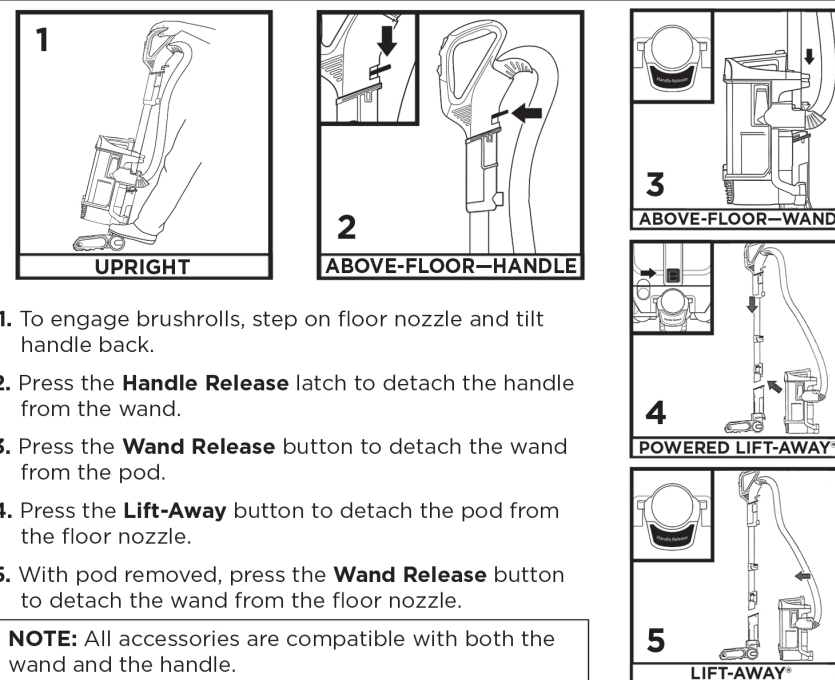

1. To engage brushrolls, step on floor nozzle and tilt handle back.
2. Press the **Handle Release** latch to detach the handle from the wand.
3. Press the **Wand Release** button to detach the wand from the pod.
4. Press the **Lift-Away** button to detach the pod from the floor nozzle.
5. With pod removed, press the **Wand Release** button to detach the wand from the floor nozzle.

**NOTE:** All accessories are compatible with both the wand and the handle.

### EMPTYING THE DUST CUP

**IMPORTANT:** Unplug the power cord before performing any maintenance.

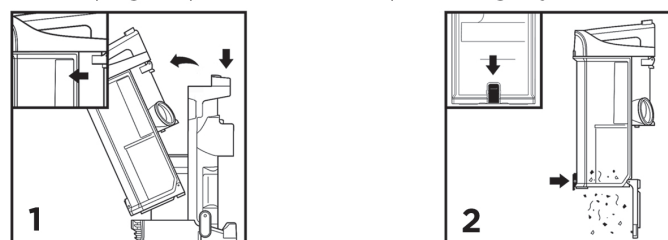

1. To remove **Dust Cup**, press release button on top of the pod. Tilt dust cup away from wand, then lift to remove.
2. To empty debris into trash, press lower release button and bottom of dust cup will drop open.

SAVE THESE INSTRUCTIONS

**EMPTYING THE DUST CUP - Cont.**

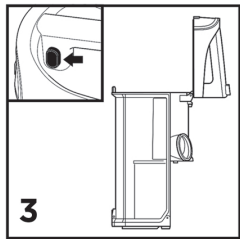

3. To remove collected debris from **Lint Screen**, press top release button and lift handle to access screen.

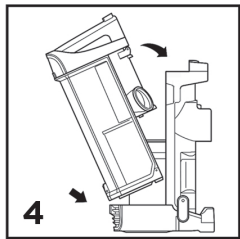

4. To reinstall, place bottom of dust cup into pod and then tilt until it clicks into place.

**CLEANING AND REPLACING THE FILTERS**

**CLEANING FILTERS**

**Regularly rinse and replace the filters to maintain your vacuum's suction power.**

To prevent damage from cleaning chemicals, rinse filters with cold water only. Allow all filters to air-dry for at least 24 hours before reinstalling them to prevent liquid from being drawn into electric parts.

**IMPORTANT: DO NOT** use soap when cleaning the filters.

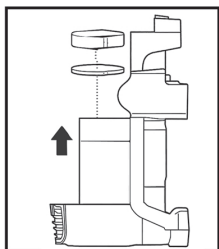

CLEAN PRE-MOTOR FILTERS EVERY MONTH

Remove **Dust Cup**, then lift out **Filters**.

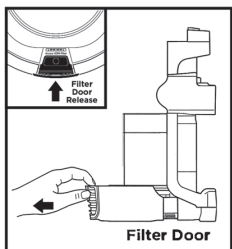

CLEAN HEPA FILTER EVERY YEAR

With the dust cup removed, press button on **Filter Door**. Pull forward and slide out to remove, then take out **HEPA Filter**.

To reinstall, insert HEPA filter into unit and replace filter door.

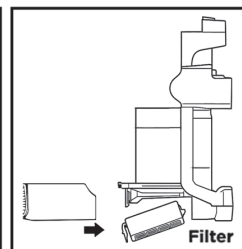

**NOTE:** The pre-motor filters should be replaced every 2.5 years. The post-motor filter should be replaced every 3 years.

**MAINTENANCE**

**NOZZLE MAINTENANCE**

**SELF-CLEANING BRUSHROLL**

If any hair is wrapped around the brushroll, continue vacuuming, using Carpet/Low Pile mode on a bare floor surface, a low-pile carpet, or a small area rug. This will allow the self-cleaning brushroll to remove the hair wrap and send it to the dust cup.

If you run over a hard or sharp object or notice a noise change while vacuuming, check for blockages or objects caught in the brushroll.

If some fibers remain wrapped around the brushroll after continued use, clear them from the brushroll.

**CLEANING THE SOFT ROLLER**

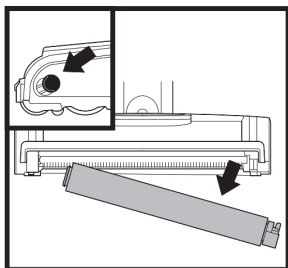

Slide the Soft Roller access button forward to release the Soft Roller.

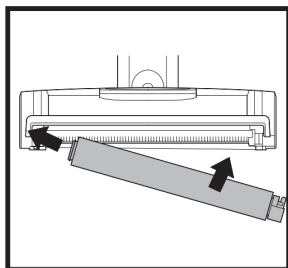

Hand wash the Soft Roller as needed. Use only water, and allow it to air-dry completely for at least 24 hours. Reinsert the Soft Roller in the front of the nozzle until it clicks into place.

**CORD MAINTENANCE**

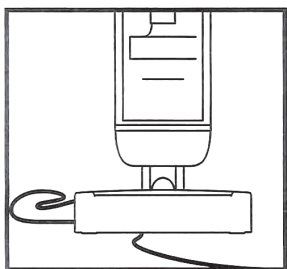

1. **DO NOT** pull or carry vacuum cleaner by the cord or use cord as a handle.
2. **DO NOT** unplug by pulling on the cord. Grasp the plug, not the cord.
3. **DO NOT** close the door on the cord.
4. **DO NOT** pull the cord around sharp corners.
5. **DO NOT** leave the cord near heated surfaces.

To minimize the risk of power cord damage, **DO NOT** run the vacuum over the power cord. If this occurs, immediately shut off power to the vacuum and remove the cord from the brushroll or nozzle.

**CHECKING FOR BLOCKAGES**

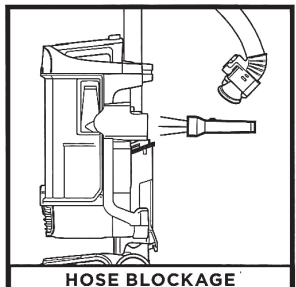

Detach hose from vacuum pod, and check hose and opening on back of pod for blockages.

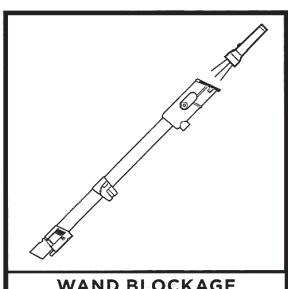

Detach wand from floor nozzle and handle, and check both ends for blockages.

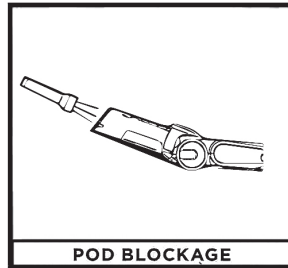

**POD BLOCKAGE**

Detach wand from floor nozzle, tilt nozzle neck back, and check opening for blockages.

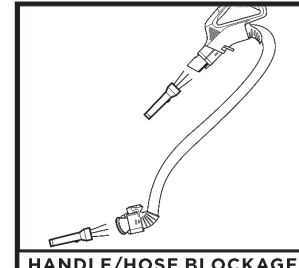

**HANDLE/HOSE BLOCKAGE**

Detach handle from wand and hose from the vacuum pod, and check openings for blockages.

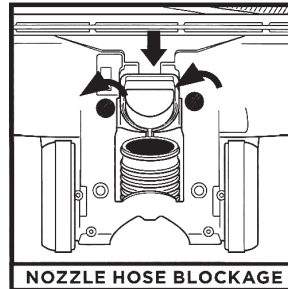

**NOZZLE HOSE BLOCKAGE**

To access the nozzle hose, open the locks on the bottom of the nozzle. With a coin, turn the locks counterclockwise, then lift the cover and clear any blockages.

**TROUBLESHOOTING**

**Power cord caught in brushroll or floor nozzle.**

- To minimize the risk of power cord damage, **DO NOT** run the vacuum over the power cord. If this occurs, immediately shut off power to the vacuum and remove the cord from the brushroll or nozzle.
- Inspect power cord and plug for any damage before use. **DO NOT** use vacuum cleaner with a damaged cord or plug. Turn off all controls before plugging in or unplugging the vacuum cleaner. Store your vacuum cleaner with the power cord secured around the two cord hooks.

**Vacuum is not picking up debris. No suction or light suction.**

- Check filters to see if they need cleaning. Follow instructions for rinsing and air-drying the filters before reinstalling them.
- Dust cup may be full; empty dust cup.
- Check hose, hose connections, nozzle, wand, pod, and accessories for blockages. Clear any blockages found. See Checking for Blockages section for more information.
- If any hair, string, or carpet fibers are wrapped around the brushroll, extend cleaning time to allow the self-cleaning brushroll to remove them. If some hair or fibers remain wrapped around brushroll after continued use, carefully remove them. See Cleaning the Brushroll section for more information.

**Vacuum lifts area rugs.**

- Make sure Surface Selector switch is set to Thick Carpet & Area Rug Cleaning.
- Suction is powerful. Take care when vacuuming area rugs or rugs with delicately sewn edges.

**Brushrolls do not spin.**

- If the Brushroll Indicator Light turns red, immediately turn off and unplug the vacuum. Remove pod and wand from floor nozzle and clear any blockages. Reconnect nozzle, plug in vacuum, and turn on power.
- With the power on, recline the handle, which will automatically turn on the brushrolls.

**Vacuum turns off on its own or indicator light flashes red.**

If your vacuum overheats, the thermostat will automatically turn off the motor. Perform the following steps to restart:

1. Turn vacuum off and unplug it.
2. Empty dust cup and clean filters. See Emptying the Dust Cup and Cleaning the Filters section for more information.
3. Check for blockages in hose, wand, floor nozzle, accessories, and inlet openings.
4. Allow unit to cool for a minimum of 60 minutes.
5. Plug in vacuum and turn it on.

**REFURBISHED PRODUCT LIMITED NINETY DAYS WARRANTY**

The **Refurbished Product Service Center** offers the following WARRANTY to the ORIGINAL purchaser of a product which we have refurbished.

This product that has been refurbished is warranted against any electronic or mechanical defects for a period of NINETY DAYS from the date of the original purchase by the consumer. Since this unit was sold as a refurbished item, the warranty does not apply to any cosmetic appearance items such as scratches. Should a defect occur, the **Refurbished Product Service Center** will repair or, at its option, replace defective unit/parts with new or rebuilt materials without charge for either parts or labor. Replacement unit/parts will be warranted for the remaining portion of the original warranty period.

This warranty does not cover installation or damage from accident, misuse, abuse, improper wiring, incorrect voltage, operating the unit against the instructions in the owner's manual or any product which has been opened, altered, or tampered with.

This warranty does not cover costs for removal and or installation of the unit for repair. Under no circumstances shall the service center be liable for any special, incidental or consequential damages or for any other expenses incurred by reason of use or sale of this product. This warranty is in lieu of any other warranties expressed or implied warranty of merchantability of fitness for particular use or otherwise.

This warranty gives the consumer specific legal rights and they may also have other rights which vary from State to State. Some States do not follow the exclusion or limitation of incidental or consequential damages, hence the above exclusion and limitations may not apply.

**Refurbished Product Service Center**

13225 Marquardt Avenue Santa Fe Springs, CA 90670.

**WARRANTY REPAIR INFORMATION**

If you need service on your unit and this product requires repair during the 90 days warranty period; please go to [www.ConsumerServiceRefurbish.com](http://www.ConsumerServiceRefurbish.com) or call the **Refurbished Product Service Center** at 562-946-3531 to obtain the required return authorization (RA) number. Pack the unit properly (the original carton is ideal for this purpose) along with a copy of your purchase receipt and a letter describing the problem. Send the unit freight prepaid and insured to:

**Refurbished Product Service Center,**

Att: Customer Service Department 13225 Marquardt Avenue Santa Fe Springs, CA 90670

Your unit will be promptly repaired and returned to you.

We will refuse to accept delivery of the returned unit unless the assigned RA number appears on the outside of the shipping carton.

**Owner's Information**

(Keep for your permanent records)

NAME: \_\_\_\_\_

ADDRESS: \_\_\_\_\_

CITY: \_\_\_\_\_ STATE: \_\_\_\_\_ ZIP CODE: \_\_\_\_\_

PHONE: \_\_\_\_\_ E-MAIL: \_\_\_\_\_

MODEL: \_\_\_\_\_ SERIAL NO.: \_\_\_\_\_



PRINTED IN MEXICO Elbrd: M.C.  
OBPN: AZ1810\_Series\_IB\_E\_MP\_Mv4\_220331  
SC: 03-07-2023\_TAB SHNMDL: AZ1810



Please be sure to read the enclosed Shark® Owner's Guide prior to using your unit.

# Shark

## QUICK START GUIDE

### WHAT'S INSIDE

- (A) Wand
- (B) Vacuum Pod
- (C) Handle & Hose
- (D) Floor Nozzle
- (E) Upholstery Tool
- (F) Crevice Tool

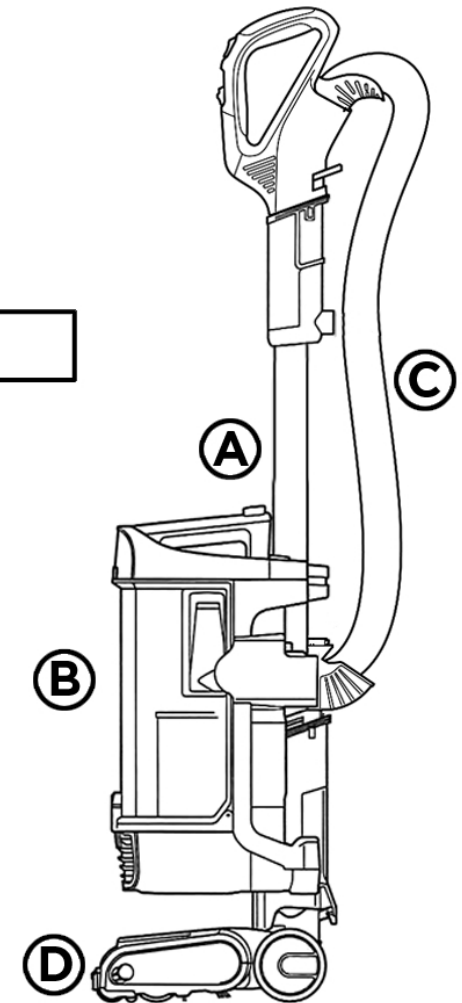
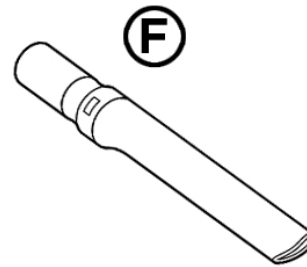
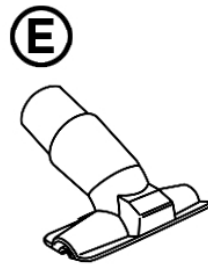

**NOTE:** The images shown here are for illustrative purpose only and may vary.



8 1 4 0 0 0 0 2 1

PRINTED IN MEXICO

Elbrd: M.C.

OBPN: BxFlp

SC: 03-07-2023\_5P

SHNMDL: AZ1810\_B