

# Shark

## Navigator® Lift-Away® XL Upright Vacuum

Please read this manual carefully before operating your unit and retain for future reference.

814100020

### IMPORTANT SAFETY INSTRUCTIONS FOR HOUSEHOLD USE ONLY

#### ⚠ WARNING

To reduce the risk of fire, electric shock, injury, or property damage, when using an electrical appliance, basic precautions should always be followed, including the following:

#### READ ALL INSTRUCTIONS BEFORE USING THIS VACUUM

1. Inspect power cord and plug for any damage before use. **DO NOT** use vacuum cleaner with a damaged cord or plug. Turn off all controls before plugging in or unplugging the vacuum cleaner. Store your vacuum cleaner with the power cord secured around the two cord hooks. To minimize the risk of power cord damage, do not allow the motorized brush roll to ingest the cord. If this occurs, immediately shut off power to the vacuum and remove the cord.
2. This appliance has a polarized plug, if the plug does not fit fully into the outlet, reverse the plug (one blade is wider than the other). If it still does not fit, contact a qualified electrician. **DO NOT** force into outlet or try to modify to fit.
3. Your vacuum cleaner may consist of a motorized nozzle, wand, hose, and/or vacuum pod. This device contains electrical connections, electrical wiring, and moving parts that potentially present risk to the user.
4. Use only identical replacement parts.
5. Carefully observe and follow the instructions provided below to avoid improper use of the appliance. **DO NOT** use the vacuum for any purpose other than those described in this manual.
6. Before use, carefully inspect all parts for any damage. **DO NOT** use if any parts are damaged.
7. The use of an extension cord is **NOT** recommended.
8. This vacuum cleaner contains no serviceable parts.
9. This appliance can be used by persons with reduced physical, sensory or mental capabilities or lack of experience and knowledge if they have been given supervision or instruction concerning use of the appliance in a safe way and understand the hazards involved. Cleaning and user maintenance shall not be made by children. Keep the appliance and its cord out of reach of children. **DO NOT** allow the appliance to be used by children. **DO NOT** allow to be used as a toy. Close supervision is necessary when used near children.
10. Always turn off the vacuum cleaner before connecting or disconnecting any motorized nozzles or other accessories.
11. **DO NOT** handle plug or vacuum cleaner with wet hands.
12. **DO NOT** use without filters in place.
13. Only use Shark® branded filters and accessories.
14. **DO NOT** damage the power cord:
  - a) **DO NOT** pull or carry vacuum cleaner by the cord or use the cord as a handle.
  - b) **DO NOT** unplug by pulling on cord. Grasp the plug, not the cord.
  - c) **DO NOT** run the vacuum cleaner over the power cord, close a door on the cord, pull the cord around sharp corners, or leave the cord near heated surfaces.
15. **DO NOT** put any objects into nozzle or accessory openings. **DO NOT** use with any opening blocked; keep free of dust, lint, hair, and anything that may reduce airflow.
16. **DO NOT** use if nozzle or accessory airflow is restricted. If the air paths or the motorized floor nozzle become blocked, turn the vacuum cleaner off and unplug from electrical outlet. Remove all obstructions before you plug in and turn on the unit again.
16. **DO NOT** use if nozzle or accessory airflow is restricted. If the air paths or the motorized floor nozzle become blocked, turn the vacuum cleaner off and unplug from electrical outlet. Remove all obstructions before you plug in and turn on the unit again.
17. Keep nozzle and all vacuum openings away from hair, face, fingers, uncovered feet, or loose clothing.
18. **DO NOT** use if vacuum cleaner is not working as it should, or has been dropped, damaged, left outdoors, or dropped into water.
19. Use extra care when cleaning on stairs.
20. **DO NOT** leave the vacuum cleaner unattended while plugged in.
21. When powered on, keep the vacuum cleaner moving over the carpet surface at all times to avoid damaging the carpet fibers.
22. **DO NOT** place vacuum cleaner on unstable surfaces such as chairs or tables.
23. Your Shark® vacuum may not be designed to stand up on its own. When taking a break from cleaning, you may need to lean it against furniture or a wall, or lay it flat on the floor. Using the vacuum for an application where the unit lacks stability may result in personal injury.
24. **DO NOT** use to pick up:
  - a) Liquids
  - b) Large objects
  - c) Hard or sharp objects (glass, nails, screws, or coins)
  - d) Large quantities of dust (drywall dust, fireplace ash, or embers). **DO NOT** use as an attachment to power tools for dust collection.
  - e) Smoking or burning objects (hot coals, cigarette butts, or matches)
  - f) Flammable or combustible materials (lighter fluid, gasoline, or kerosene)
  - g) Toxic materials (chlorine bleach, ammonia, or drain cleaner)
25. **DO NOT** use in the following areas:
  - a) Poorly lit areas
  - b) Wet or damp surfaces
  - c) Outdoor areas
  - d) Spaces that are enclosed and may contain explosive or toxic fumes or vapors (lighter fluid, gasoline, kerosene, paint, paint thinners, mothproofing substances, or flammable dust)
26. Turn off all controls before plugging in or unplugging the vacuum.
27. Unplug from electrical outlet when not in use and before any maintenance or cleaning.
28. Hand wash with water only. Washing with cleaning chemicals could damage the unit.
29. During cleaning or routine maintenance, **DO NOT** cut anything other than hair, fibers, or string wrapped around the brushroll.
30. Allow all filters to air-dry completely before replacing in the vacuum to prevent liquid from being drawn into electric parts.
31. Make sure the dust cup and all filters are in place after routine maintenance.
32. If provided, secure the power cord around the two cord hooks during storage.

### SAVE THESE INSTRUCTIONS

#### TECHNICAL SPECIFICATIONS

Voltage: 120V- 60Hz

#### OWNER'S GUIDE

#### ASSEMBLY

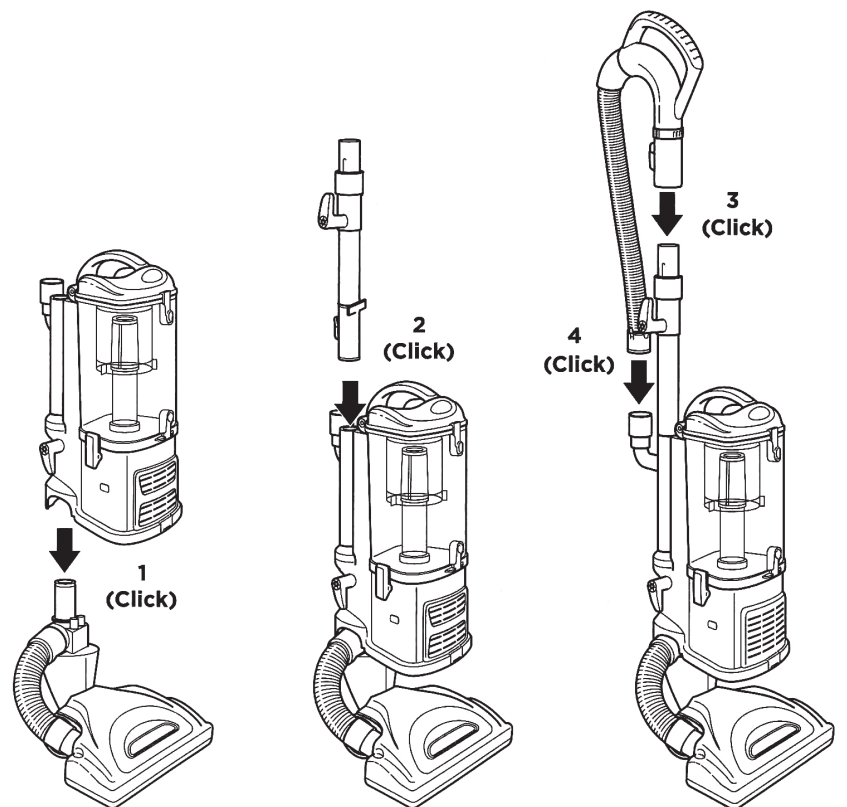

1. Place the **Pod** onto the **Floor Nozzle Post**.
2. Insert the **Wand** into the pod.
3. Insert the **Handle** into the wand.
4. Connect the **Hose** to the back of the pod.

For proper operation, ensure all parts are firmly clicked into place.

NOTE: Accessories may vary depending on the model. Refer to quick guide, if available.

The images shown here are for illustrative purposes only and may be subject to change.

#### WHOLE-HOME CLEANING

#### SETTINGS

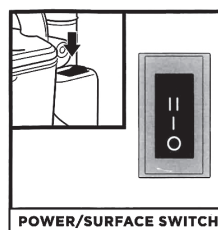

Press the **Power/Surface Switch** at the top of the pod.

Select surface setting:

- O Off**
- I Hard Floor**  
For hard floors and small area rugs.
- II Carpet**  
For carpets.

NOTE: Brushroll spins in Carpet mode only.

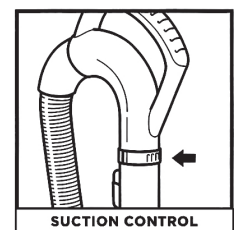

Rotate the **Suction Control Slider** on the handle to adjust the suction depending on the floor type.

**MIN:** to reduce suction and increase maneuverability on carpets.  
**MAX:** to increase suction on hard floors.

#### BRUSHROLL INDICATOR LIGHT

#### WHAT DOES THE BRUSHROLL INDICATOR LIGHT MEAN?

- Solid Green:** The brushroll is spinning and working as intended.
- Solid Red:** There is a jam in the brushroll area. Turn off the vacuum and unplug it, then remove any blockages in the nozzle.
- Flashing Red:** The motorized floor nozzle is overheating. Turn off the vacuum, unplug it, and remove any blockages. Let the vacuum cool down for at least 60 minutes before restarting. See Troubleshooting section for more information.

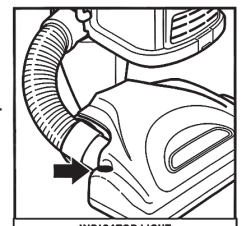

NOTE: For deep carpet cleaning per ASTM F608 (embedded dirt in carpets), use setting II, Carpet.

#### CLEANING MODES

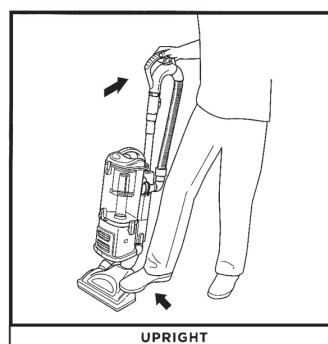

UPRIGHT

To engage brushroll, select Carpet mode, then step on floor nozzle and tilt handle back.

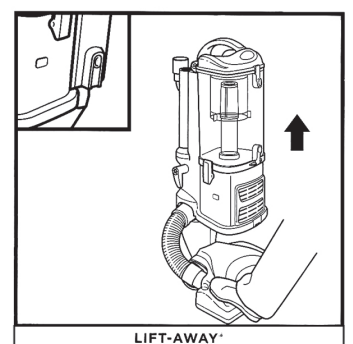

LIFT-AWAY

Press the red **Release Button** on the side of the pod. Step on the floor nozzle and lift off the pod.

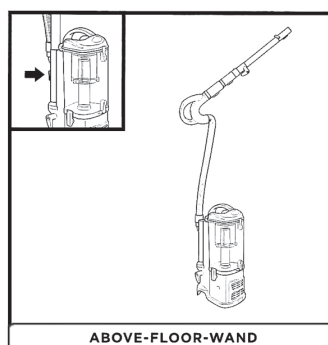

ABOVE-FLOOR-WAND

With pod removed, press the **Wand Release** button to detach the wand from the pod. Attach an accessory to the end of the wand.

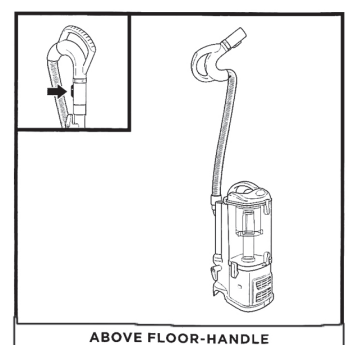

ABOVE FLOOR-HANDLE

With pod removed, press the **Handle Release** button to detach the handle from the wand. Attach an accessory to the end of the handle.

NOTE: All accessories are compatible with both the wand and the handle.



### EMPTYING THE DUST CUP

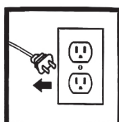

**IMPORTANT:** Unplug the power cord before performing any maintenance. Empty the dust cup each time you vacuum and periodically during cleaning, when debris in the dust cup reaches the MAX fill line.

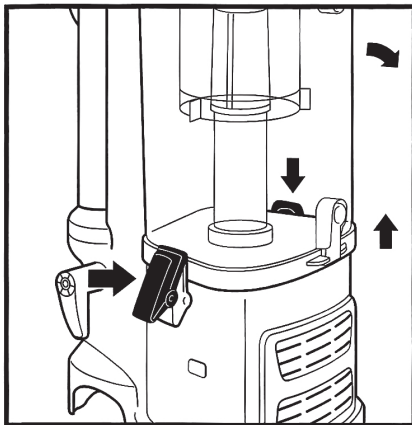

Undo the **Latches** on the sides of the dust cup by lifting them up and out. Tilt the dust cup and lift it off vacuum pod.

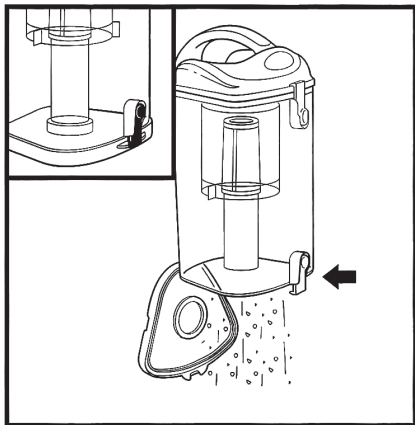

To empty debris into trash, press the lower release button and the bottom lid will drop open.

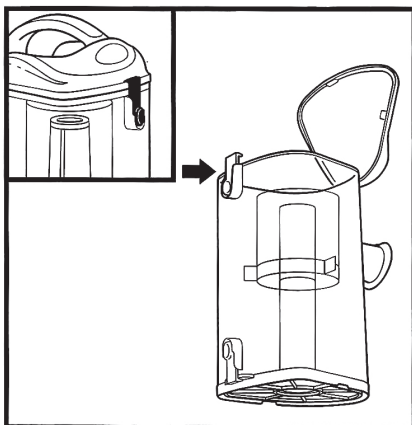

To remove collected debris from **Lint Screen**, press the top release button and lift the handle to open. Gently brush lint screen to clean.

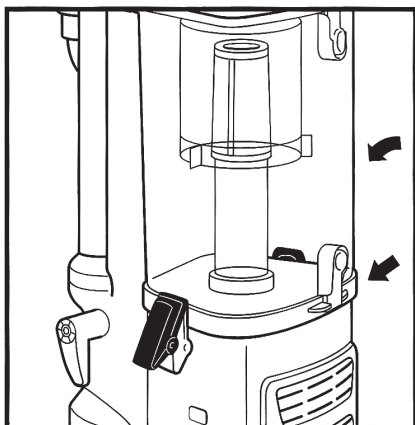

To reinstall, set the bottom of the dust cup and tilt until dust cup clicks into place.

### CLEANING AND REPLACING THE FILTERS

#### CLEANING FILTERS

**Regularly rinse and replace the filters to maintain your vacuum's suction power.**

To prevent damage from cleaning chemicals, rinse filters with cold water **ONLY**. Allow all filters to air-dry for at least 24 hours before reinstalling them to prevent liquid from being drawn into electric parts.

**IMPORTANT: DO NOT** use soap when cleaning the filters.

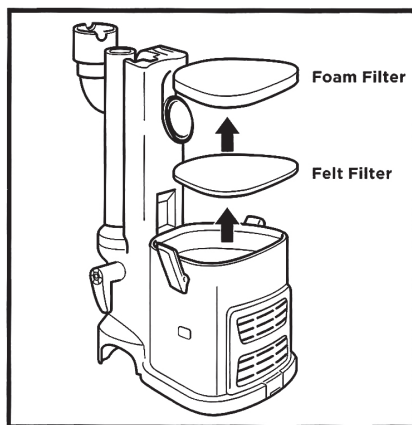

**Pre-Motor (foam and felt):** With the dust cup removed, remove the **Foam** and **Felt Filters**.

**CLEAN PRE-MOTOR FILTERS EVERY 3 MONTHS.**

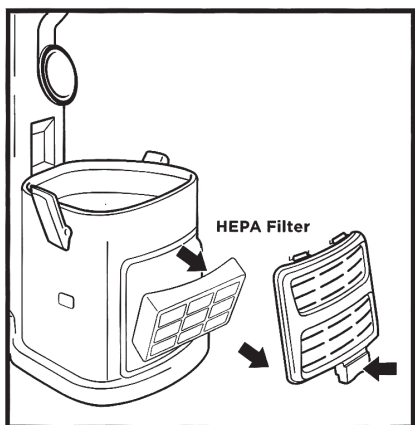

**Post-Motor (HEPA):** To access the **HEPA filter**, press the tab, tilt the **Filter Cover**, and lift it from the vacuum. Remove the HEPA filter.

**CLEAN HEPA FILTER EVERY YEAR.**

### CORD MAINTENANCE

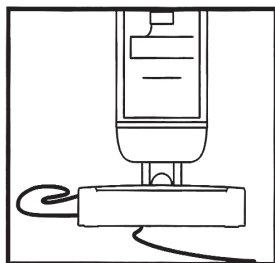

- DO NOT** pull or carry vacuum cleaner by the cord or use cord as a handle.
- DO NOT** unplug by pulling on the cord. Grasp the plug, not the cord.
- DO NOT** close the door on the cord.
- DO NOT** pull the cord around sharp corners.
- DO NOT** leave the cord near heated surfaces.

To minimize the risk of power cord damage, **DO NOT** run the vacuum over the power cord. If this occurs, immediately shut off power to the vacuum and remove the cord from the brushroll or nozzle.

### MAINTENANCE

#### CLEANING THE BRUSHROLL

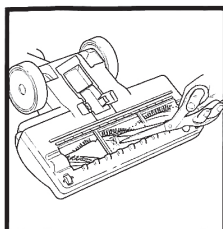

- Detach the pod from the floor nozzle.
- Remove any blockages or buildup from the airways in the nozzle. With scissors, carefully cut away any fibers, hair, or string wrapped around the brushroll. Avoid damaging or cutting the bristles.

**NOTE:** Accessories may vary depending on the model.

The images shown here are for illustrative purposes only and may be subject to change.

### CHECKING FOR BLOCKAGES

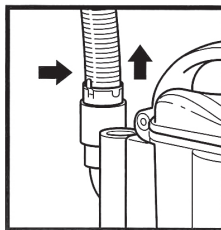

Detach the handle from the wand by pressing the handle release button. Remove the hose from the pod by pressing the tabs on the hose collar. Inspect the hose for clogs.

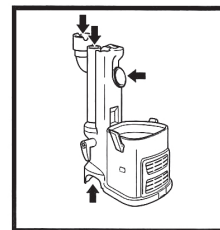

Detach the pod, wand, hose, and dust cup. Check all openings and remove blockages.

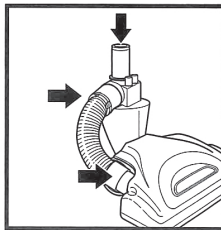

With the pod detached, remove the lower nozzle hose and check for clogs.

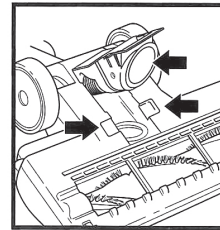

Open the airway on the bottom of the floor nozzle by squeezing the tabs on the sides and lifting up. Check for clogs and clear away any obstructions.

### TROUBLESHOOTING

#### Power cord caught in brushroll or floor nozzle.

- To minimize the risk of power cord damage, **DO NOT** run the vacuum over the power cord. If this occurs, immediately shut off power to the vacuum and remove the cord from the brushroll or nozzle.
- Inspect power cord and plug for any damage before use. **DO NOT** use vacuum cleaner with a damaged cord or plug. Turn off all controls before plugging in or unplugging the vacuum cleaner. Store your vacuum cleaner with the power cord secured around the two cord hooks.

#### Vacuum is not picking up debris. No suction or light suction.

- Check filters to see if they need cleaning. Follow instructions for rinsing and air-drying the filters before reinstalling.
- Dust cup may be full; empty dust cup.
- Clear any blockages in the hose, hose connections, nozzle, wand, pod, or accessories. See Checking for Blockages section for more information.
- If any string, hair, or carpet fibers are wrapped around the brushroll, carefully cut debris with scissors and remove from brushroll. See Nozzle Maintenance section for more information.

#### Vacuum lifts area rugs.

- Make sure Power/Surface switch is set to Hard Floor (setting I).
- Suction is powerful. Take care when vacuuming area rugs or rugs with delicately sewn edges.
- To minimize suction, set the suction control slider to MIN. See the Suction Control section for more information.

#### Brushroll does not spin.

- If the brushroll indicator light turns red, immediately turn off and unplug the vacuum. Remove pod from floor nozzle and clear any blockages. Reconnect nozzle, plug in vacuum, and turn on power.
- With the power on, recline the handle, which will automatically turn on the brushroll.

#### Vacuum turns off on its own or indicator light flashes red.

If your vacuum overheats, the thermostat will automatically turn off the motor. Follow these steps to restart:

- Turn vacuum off and unplug it.
- Empty dust cup and clean filters (see Emptying the Dust Cup and Cleaning Filters).
- Check for blockages in hose, wand, nozzle, accessories, and inlet openings.
- Allow unit to cool for a minimum of 60 minutes.
- Plug in vacuum and turn it on.

### REFURBISHED PRODUCT LIMITED NINETY DAYS WARRANTY

The **Refurbished Product Service Center** offers the following WARRANTY to the ORIGINAL purchaser of a product which we have refurbished.

This product that has been refurbished is warranted against any electronic or mechanical defects for a period of NINETY DAYS from the date of the original purchase by the consumer. Since this unit was sold as a refurbished item, the warranty does not apply to any cosmetic appearance items such as scratches. Should a defect occur, the **Refurbished Product Service Center** will repair or, at its option, replace defective unit/parts with new or rebuilt materials without charge for either parts or labor. Replacement unit/parts will be warranted for the remaining portion of the original warranty period.

This warranty does not cover installation or damage from accident, misuse, abuse, improper wiring, incorrect voltage, operating the unit against the instructions in the owner's manual or any product which has been opened, altered, or tampered with.

This warranty does not cover costs for removal and/or installation of the unit for repair. Under no circumstances shall the service center be liable for any special, incidental or consequential damages or for any other expenses incurred by reason of use or sale of this product. This warranty is in lieu of any other warranties expressed or implied warranty of merchantability of fitness for particular use or otherwise.

This warranty gives the consumer specific legal rights and they may also have other rights which vary from State to State. Some States do not follow the exclusion or limitation of incidental or consequential damages, hence the above exclusion and limitations may not apply.

**Refurbished Product Service Center**

13225 Marquardt Avenue Santa Fe Springs, CA 90670.

### WARRANTY REPAIR INFORMATION

If you need service on your unit and this product requires repair during the 90 days warranty period; please go to [www.ConsumerServiceRefurbish.com](http://www.ConsumerServiceRefurbish.com) or call the **Refurbished Product Service Center** at 562-946-3531 to obtain the required return authorization (RA) number. Pack the unit properly (the original carton is ideal for this purpose) along with a copy of your purchase receipt and a letter describing the problem. Send the unit freight prepaid and insured to:

**Refurbished Product Service Center,**

**Att: Customer Service Department 13225 Marquardt Avenue Santa Fe Springs, CA 90670**

Your unit will be promptly repaired and returned to you.

We will refuse to accept delivery of the returned unit unless the assigned RA number appears on the outside of the shipping carton.

#### Owner's Information

(Keep for your permanent records)

NAME: \_\_\_\_\_

ADDRESS: \_\_\_\_\_

CITY: \_\_\_\_\_ STATE: \_\_\_\_\_ ZIP CODE: \_\_\_\_\_

PHONE: \_\_\_\_\_ E-MAIL: \_\_\_\_\_

MODEL: \_\_\_\_\_ SERIAL NO.: \_\_\_\_\_

#### PLEASE READ CAREFULLY AND KEEP FOR FUTURE REFERENCE.

This Owner's Guide is designed to help you get a complete understanding of your new Shark Navigator® Lift-Away® XL.

SharkNinja Operating LLC

Illustrations may differ from actual product. We are constantly striving to improve our products; therefore the specifications contained herein are subject to change without notice.

814100020



PRINTED IN MEXICO / SC: 14-02-2023

OBPN: CU512\_IB\_E\_MP\_Mv3\_220428

SHNMDL: CU512\_B / TAB / Elbrd:J.E.

Please be sure to read the enclosed Shark® Owner's Guide prior to using your unit.

## QUICK START GUIDE

### WHAT'S INSIDE:

- (A) Vacuum Pod
- (B) Floor Nozzle
- (C) Wand
- (D) Handle & Hose
- (E) Crevice Tool

(E)



**Note:** Accessories may vary depending on the model.

The images shown here are for illustrative purposes only and may be subject to change.

PRINTED IN MEXICO Elbrd: J.E.  
OBPN: N/A MODEL: CU512\_B  
SC: 14-02-2023\_05P



814000020

### ASSEMBLY

1. Place **Pod** onto **Floor Nozzle Post**.
2. Insert **Wand** into pod.
3. Insert **Handle** into wand.
4. Connect **Hose** to back of pod.

For proper operation, ensure all parts are firmly clicked into place.

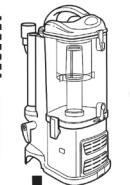

1  
(Click)

(A)

(B)

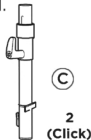

(C)  
2  
(Click)

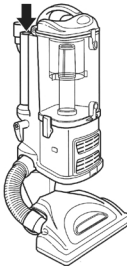

4  
(Click)

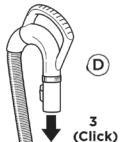

(D)  
3  
(Click)

