

Shark® ROTATOR®

POWERED LIFT-AWAY

INSTRUCTIONS



PLEASE READ CAREFULLY AND KEEP FOR FUTURE REFERENCE.
This Owner's Guide is designed to help you get a complete understanding of your new Shark Rotator Powered Lift-Away Upright Vacuum.

SharkNinja Operating LLC
US: Newton, MA 02459
CAN: Ville St-Laurent, QC H4S 1A7
Illustrations may differ from actual product.
Shark, Rotator and Lift-Away are registered trademarks of SharkNinja Operating LLC.
For SharkNinja U.S. Patent information, visit sharkninja.com/USPatents.

IMPORTANT SAFETY INSTRUCTIONS FOR HOUSEHOLD USE ONLY

⚠ WARNING

To reduce the risk of injury, fire, electric shock, and property damage resulting from improper use of the appliance, carefully observe the following instructions. This unit contains electrical connections and moving parts that potentially present risk to the user.

THE MOTORIZED FLOOR NOZZLE, WAND, AND HANDLE CONTAIN ELECTRICAL CONNECTIONS:

- These are not serviceable parts.
- Do not use to vacuum any liquids.
- Do not immerse in water.
- If handle/wand is damaged, discontinue use.

- 1 Inspect power cord or plug for any damage before use. DO NOT use vacuum cleaner with a damaged cord or plug. Turn off all controls before plugging or unplugging the vacuum cleaner. Store your vacuum cleaner with the power cord secured around the two cord hooks.
- 2 DO NOT use outdoors or on wet surfaces. Use only on dry surfaces.
- 3 Unplug from electrical outlet when not in use and before servicing.
- 4 If vacuum cleaner is not working as it should, has been dropped, damaged, left outdoors, or dropped into water, call a service center.
- 5 The hose contains electrical wires. DO NOT use when damaged, cut, or punctured.
- 6 DO NOT pull or carry vacuum cleaner by the cord or use the cord as a handle.
- 7 DO NOT unplug by pulling on cord. Grasp the plug, not the cord.
- 8 DO NOT handle plug or vacuum cleaner with wet hands.
- 9 DO NOT run the vacuum cleaner over the power cord, close a door on the cord, or pull cord around sharp corners.
- 10 The use of an extension cord is NOT recommended.
- 11 DO NOT leave vacuum cleaner unattended when plugged in.
- 12 Keep cord away from heated surfaces.
- 13 Always turn off the vacuum cleaner before connecting or disconnecting motorized nozzle.

GENERAL USE

- 14 Use only as described in this manual.
- 15 Keep your work area well lit.
- 16 Keep the vacuum cleaner moving over the carpet surface at all times to avoid damaging the carpet fibers.
- 17 DO NOT place vacuum cleaner on unstable surfaces such as chairs or tables.
- 18 DO NOT put any objects into openings. DO NOT use with any opening blocked; keep free of dust, lint, hair, and anything that may reduce airflow.
- 19 DO NOT allow the appliance to be used by children. Close attention is necessary when used near children. This is not a toy.
- 20 DO NOT use without dust cup and/or filters in place.

DUST CUP/FILTERS/ACCESORIES

Before turning on the vacuum:

- 21 Make sure that all filters are thoroughly dry after routine cleaning.
- 22 Make sure that dust cup and all filters are in place after routine maintenance.
- 23 Make sure accessories are free of blockages.
- 24 Only use Shark-brand filters and accessories (failure to do so will void the warranty).

HOSE ATTACHMENTS

- 25 DO NOT use if airflow is restricted; if the air paths or the motorized floor nozzle become blocked, turn the vacuum cleaner off and unplug from electrical outlet. Remove all obstructions before you turn on the unit again.
- 26 Keep the end of the hose and accessory openings away from face and body.
- 27 Keep cleaning tools and hose suction openings away from hair, face, fingers, uncovered feet, or loose clothing.
- 28 Only use manufacturer's recommended attachments.

GENERAL CLEANING

- 29 DO NOT pick up large-sized objects.
- 30 DO NOT pick up hard or sharp objects such as glass, nails, screws, or coins that could damage the vacuum cleaner.

- 31 DO NOT use to pick up drywall dust, fireplace ash, or embers. Do not use as an attachment to power tools for dust collection.
- 32 DO NOT pick up smoking or burning objects such as hot coals, cigarette butts, or matches.
- 33 DO NOT pick up flammable or combustible materials (e.g., lighter fluid, gasoline, or kerosene) or use vacuum in areas where they may be present.
- 34 DO NOT pick up toxic solutions (e.g., chlorine bleach, ammonia, or drain cleaner).
- 35 DO NOT use in an enclosed space where vapors are present from paint, paint thinner, moth-proofing substances, flammable dust, or other explosive or toxic materials.
- 36 DO NOT vacuum up any liquids.
- 37 DO NOT immerse vacuum cleaner in water or other liquids.
- 38 Use extra care when cleaning on stairs.

POLARIZED PLUG

To reduce the risk of electric shock, this vacuum cleaner has a polarized plug (one blade is wider than the other). As a safety feature, this plug will fit into a polarized outlet only one way. If the plug does not fit fully into the outlet, reverse the plug. If it still does not fit, contact a qualified electrician. DO NOT force into outlet or try to modify to fit.

GETTING TO KNOW YOUR SHARK® ROTATOR® POWERED LIFT-AWAY™ UPRIGHT VACUUM

WELCOME!

Congratulations on your purchase. Use this instruction manual to learn about your new vacuum's great features. From assembly to use to maintenance, you will find it all in here.

MAIN UNIT

- A Surface Selector
- B Power Button
- C Hose
- D Handle Release Button
- E Hose Clip
- F Upper Cord Hook
- G Lift-Away Button
- H Wand Release Button
- I Lift-Away Pod
- J Wand
- K Lower Cord Hook
- L Motorized Floor Nozzle
- M Brushroll Indicator Light
- N Headlights

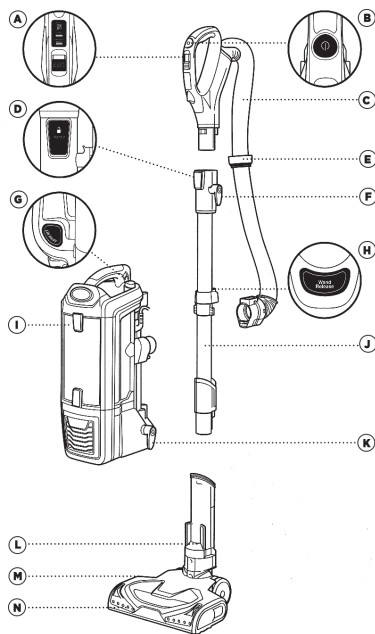

ASSEMBLING YOUR VACUUM

TIP: Slide hose clip into back of wand for convenience.

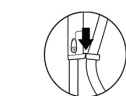

TIP: For quick cord access, rotate upper hook down and remove cord.



TIP: To store your vacuum, wrap cord around cord hooks.

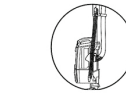

STEP 1 Place selected floor nozzle on floor and insert wand.

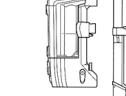

STEP 2 Insert handle into wand.

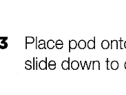

STEP 3 Place pod onto wand and slide down to connect.



STEP 4 Connect hose into back of pod until you hear a click.

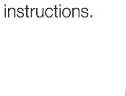

STEP 5 Place tools on their accessory posts.

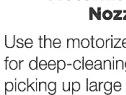

STEP 1



STEP 2



STEP 3 Place pod onto wand and slide down to connect.



STEP 4 Connect hose into back of pod until you hear a click.



STEP 5 Place tools on their accessory posts.



USING YOUR VACUUM IN UPRIGHT MODE

⚠ WARNING: DO NOT use to pick up drywall dust, fireplace ash, or embers. DO NOT use as an attachment to power tools for dust collection.

WHAT DOES THE BRUSHROLL INDICATOR LIGHT MEAN?

Solid Green

The brushroll is on and working as it should.

Solid Red

There is a jam in the brushroll area. Turn your vacuum off and remove the blockage.

Flashing Red*

The motorized floor nozzle is overheating. Turn your vacuum off and wait for it to cool down. Next time you are vacuuming that surface, try opening the Suction Control.

No Light

The brushroll is off because the vacuum is in Hard Floor mode.

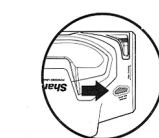

*See Troubleshooting section for further instructions.

STEP 1

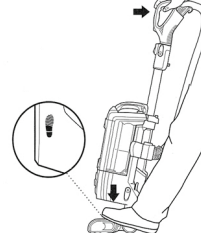

- 1 Plug power cord into outlet. Place foot on floor nozzle and tilt handle back.

STEP 2

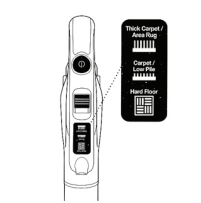

- 2 Choose the appropriate setting.
 - Thick Carpet & Area Rug Cleaning**
Set floor selector to Carpet.
 - Carpet & Low Pile Cleaning**
Set floor selector to Carpet/Low Pile.
 - Hard Floor Cleaning**
Set floor selector to Hard Floor.

NOTE: For deep cleaning per ASTM F 608 (embedded dirt in carpets) please set to Carpet/Low Pile.

STEP 3

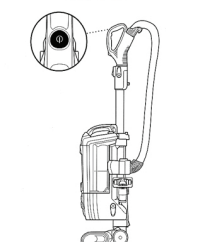

- 3 Press power button to turn vacuum on to start cleaning. The brushroll will not spin unless the wand is reclined.

USING YOUR VACUUM IN ABOVE-FLOOR MODE

Note: Accessories may vary depending on model.

The Quick Start guide shows the select accessories that are included with your model.

STEP 1

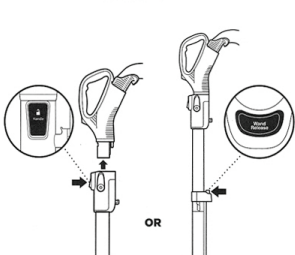

- 1 Press the Handle button **OR** Press the Wand Release button when you need to clean within short reach.

STEP 2

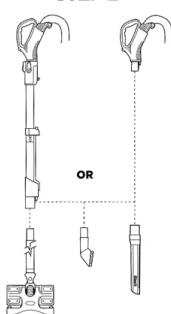

- 2 Insert desired tool directly into wand or handle.

CHANGING YOUR FLOOR NOZZLES

If your vacuum comes with a Dust-Away™ Hard Floor Attachment, use these instructions.



Motorized Floor Nozzle

Use the motorized floor nozzle for deep-cleaning carpets and picking up large debris on hard floors.

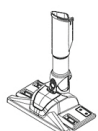

Dust-Away Hard Floor Attachment

Use the Dust-Away Hard Floor Attachment to pick up debris and wipe away fine dust on hard floors.

★ IMPORTANT: Do not use the Dust-Away Hard Floor Attachment without the microfiber pad attached.

STEP 1

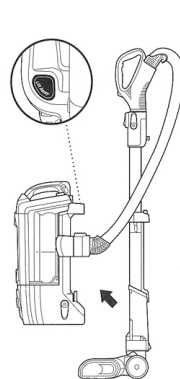

- 1 Press Lift-Away® button to lift pod off motorized floor nozzle.

STEP 2

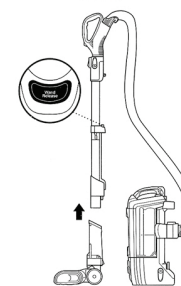

- 2 Press Wand Release button to remove wand from motorized floor nozzle.

STEP 3

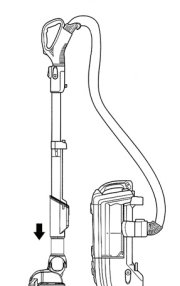

- 3 Insert wand into the Dust-Away™ Hard Floor Attachment.

Hold pod in hand to clean in Lift-Away® mode. You cannot use the Dust-Away Hard Floor Attachment in regular upright mode.

USING YOUR VACUUM IN LIFT-AWAY® MODE

WARNING: Ensure solid footing when using in Lift-Away mode. Using for an application where you lack stability may result in personal injury.

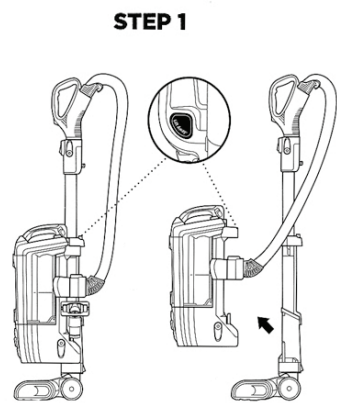

LIFT-AWAY CLEANING

- 1 Press Lift-Away button to lift pod off motorized floor nozzle. You are now ready to clean those hard-to-reach places.

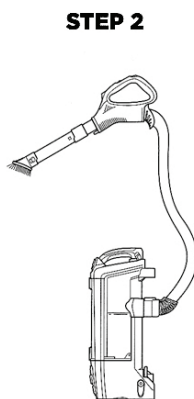

- 2 Attach desired accessory directly into handle. You can also attach the accessory to the wand for extended reach.

TROUBLESHOOTING GUIDE

WARNING: To reduce the risk of shock and unintended operation, turn power off and unplug unit before servicing.

Vacuum is not picking up debris. No suction or light suction.
(Refer to Maintenance section for more information.)

- Check filters to see if they need cleaning. Follow instructions for rinsing and drying the filters before reinserting in the vacuum.
- Dust cup may be full; empty dust cup.
- Check hose, hose connections, nozzles, and accessories for blockages; clear blockages if required.
- Remove any string, carpet fibers, or hair that may be wrapped around the brushroll.

Vacuum lifts area rugs.

- Turn off unit to disengage the brushroll. Move switch to Hard Floor setting for suction-only cleaning, and turn unit back on.
- Suction is powerful. Take care when vacuuming area rugs or rugs with delicately sewn edges.

Brushroll does not spin.

- If Brushroll Indicator Light on the motorized floor nozzle turns red, the brushroll has stopped spinning. Immediately turn off and unplug vacuum, disconnect the nozzle, and remove blockage before reconnecting and turning vacuum back on.
- With the power on, recline the handle, which will automatically turn on the brushroll.
- Make sure the carpet height selector is not set to Hard Floor.

Vacuum turns off on its own or indicator light flashes red.

- This vacuum is equipped with a motor-protective thermostat. If your vacuum overheats, the thermostat will automatically turn the suction motor off. Perform the following steps to restart the thermostat:
 1. Turn vacuum off and unplug it.
 2. Empty dust cup and clean filters (see Maintenance section).
 3. Check for blockages in hose, accessories, and inlet openings.
 4. Allow unit to cool for a minimum of 45 minutes.
 5. Plug in vacuum and turn it on.
- If hose is not fully connected to the pod, it can cause a poor electrical connection and the hose can come loose, turning the vacuum off.
 1. Turn vacuum off and unplug it.
 2. Empty dust cup and clean filters.
 3. Check for blockages in hose, accessories, and inlet openings.
 4. Remove cord from cord hook so hose latch can be seen and engaged.
 5. Ensure you hear an audible click at all connection points:
 - a. Where hose meets back of pod (may require additional force; pull on hose to ensure latch is fully engaged)
 - b. Where wand plugs into floor nozzle
 - c. Where handle plugs into wand
 6. Plug in vacuum and turn it on.

TECHNICAL SPECIFICATIONS

Voltage: 120V, 60Hz

MAINTENANCE

To keep your vacuum's suction power optimal, follow these instructions. Make sure unit is off and cord is unplugged.

WARNING: To reduce the risk of shock and unintended operation, turn power off and unplug unit before servicing.

Hand wash filters with water only to prevent damage from cleaning chemicals. Allow ALL filters to dry completely before replacing in the vacuum to prevent liquid from being drawn into electric parts.

IMPORTANT: Do not use soap when cleaning the HEPA filter.

RECOMMENDED FILTER CLEANING SCHEDULE:

Pre-Motor Filter Kit
(Foam & Felt)
XFF650
Clean every 3 months.

Post-Motor Filter
(HEPA)
XHF650
Clean once a year.

WARNING: To reduce the risk of shock and unintended operation, turn power off and unplug unit before servicing.

TIP: You do not need any tools to open the motorized floor nozzle—just a coin.

STEP 1

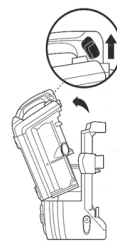

STEP 2

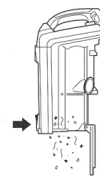

EMPTYING THE DUST CUP

- 1 Pull up on dust cup release latch and lift dust cup off pod.
- 2 Hold dust cup over a trash bin and press the empty-release latch on the bottom.

STEP 3

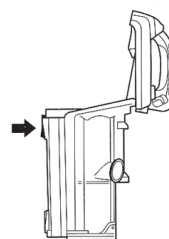

- 3 Press top dust cup release latch to access dust screen and remove built-up debris as required.

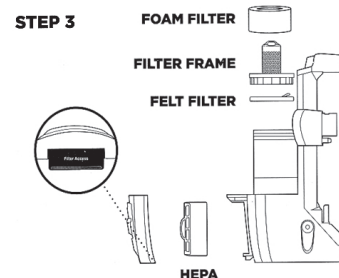

CLEANING THE FILTERS

1 Pre-Motor (foam and felt):

With the dust cup removed, take out and rinse the foam and felt filters with water. Tap loose dirt off filters between washes as needed.

2 Post-Motor (HEPA):

To access the HEPA filter, reach under the grill and pull the Filter Access latch to remove the grill. Remove and rinse the HEPA filter.

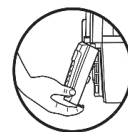

STEP 1

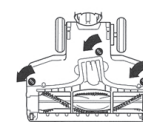

CHECKING FOR BLOCKAGES & MAINTAINING BRUSHROLL

- 1 Use a coin to unlock the 3 locks on the bottom of the floor nozzle.

STEP 2

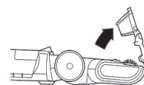

- 2 A portion of the base is hinged for better access to the brushroll and exposure to the airway. Shine a flashlight from the bottom of the base to check for blockages.

STEP 3

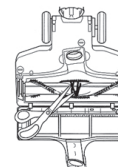

- 3 Remove any hair, fibers, or debris that is wrapped around the brushroll. There is a groove that allows a pair of scissors to cut across to loosen debris.

STEP 4

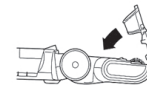

- 4 To reassemble, replace base by lining it up along the front of the nozzle. Rotate closed and lock the 3 locks.

REFURBISHED PRODUCT LIMITED NINETY DAYS WARRANTY

The **Refurbished Product Service Center** offers the following WARRANTY to the ORIGINAL purchaser of a product which we have refurbished.

This product that has been refurbished is warranted against any electronic or mechanical defects for a period of NINETY DAYS from the date of the original purchase by the consumer. Since this unit was sold as a refurbished item, the warranty does not apply to any cosmetic appearance items such as scratches. Should a defect occur, the **Refurbished Product Service Center** will repair or, at its option, replace defective unit/parts with new or rebuilt materials without charge for either parts or labor. Replacement unit/parts will be warranted for the remaining portion of the original warranty period.

This warranty does not cover installation or damage from accident, misuse, abuse, improper wiring, incorrect voltage, operating the unit against the instructions in the owner's manual or any product which has been opened, altered, or tampered with.

This warranty does not cover costs for removal and/or installation of the unit for repair. Under no circumstances shall the service center be liable for any special, incidental or consequential damages or for any other expenses incurred by reason of use or sale of this product. This warranty is in lieu of any other warranties expressed or implied warranty of merchantability of fitness for particular use or otherwise.

This warranty gives the consumer specific legal rights and they may also have other rights which vary from State to State. Some States do not follow the exclusion or limitation of incidental or consequential damages, hence the above exclusion and limitations may not apply.

Refurbished Product Service Center
13225 Marquardt Avenue Santa Fe Springs, CA 90670.

WARRANTY REPAIR INFORMATION

If you need service on your unit and this product requires repair during the 90 days warranty period; please go to www.ConsumerServiceRefurbish.com or call the **Refurbished Product Service Center** at 562-946-3531 to obtain the required return authorization (RA) number. Pack the unit properly (the original carton is ideal for this purpose) along with a copy of your purchase receipt and a letter describing the problem. Send the unit freight prepaid and insured to:

Refurbished Product Service Center,
Attn: Customer Service Department 13225 Marquardt Avenue Santa Fe Springs, CA 90670

Your unit will be promptly repaired and returned to you. We will refuse to accept delivery of the returned unit unless the assigned RA number appears on the outside of the shipping carton.

Owner's Information
(Keep for your permanent records)

NAME: _____
ADDRESS: _____
CITY: _____ STATE: _____ ZIP CODE: _____
PHONE: _____ E-MAIL: _____
MODEL: _____ SERIAL NO.: _____



Please be sure to read the enclosed Shark® Owner's Guide prior to using your unit.

Shark POWERED LIFT-AWAY®

QUICK START GUIDE

WHAT'S INSIDE

- A** Motorized Floor Nozzle
- B** Wand
- C** Handle
- D** Pet Multi-Tool
- E** Hard Floor Hero™ Attachment
- F** TruePet® Mini Motorized Brush
- G** Crevice Tool

ASSEMBLY

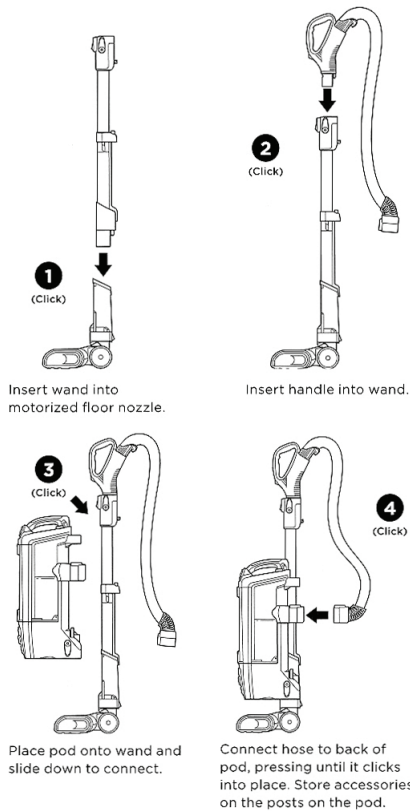

MAINTENANCE

Empty dust cup after each use

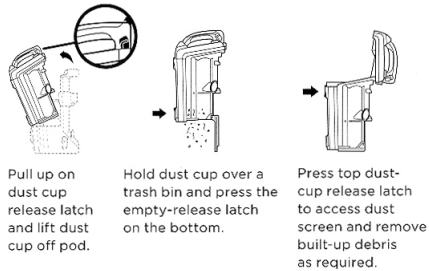

Cleaning Filters

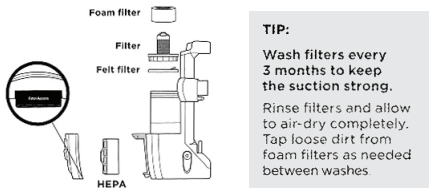

Pre-Motor (foam and felt):
With the dust cup removed, take out and rinse the foam and felt filters with water.

Post-Motor (HEPA):
To access the HEPA filter, reach under the grill and pull the Filter Access latch to remove the grill. Remove and rinse the HEPA filter.

Easy brushroll maintenance

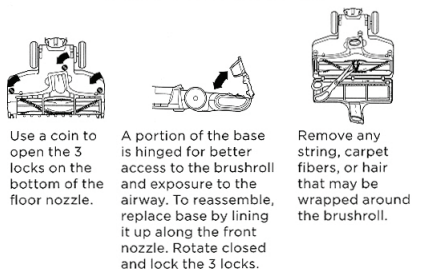

VERSATILE FLOOR-TO-CEILING CLEANING

FLOOR CLEANING

- 1 Plug In Vacuum**
To start cleaning, place your foot gently on the floor nozzle and tilt the handle back.

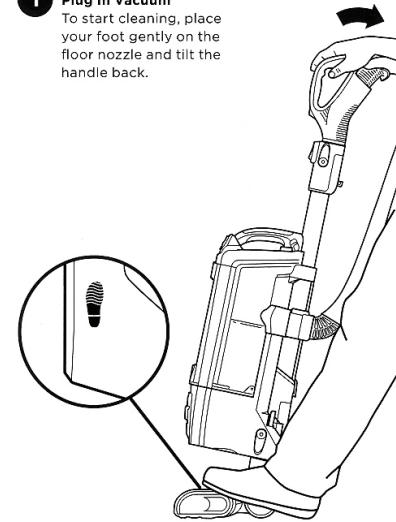

- 2 Choose Setting**
Slide the power switch to the appropriate floor setting and start cleaning.

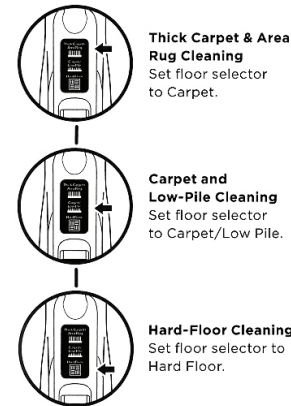

NOTE:
For deep cleaning per ASTM F 608 (embedded dirt in carpets) please set to Carpet/Low pile and Suction Control to MAX.

POWERED LIFT-AWAY® MODE

Press Lift-Away button to lift pod off floor nozzle. You are now ready to clean those hard-to-reach places.

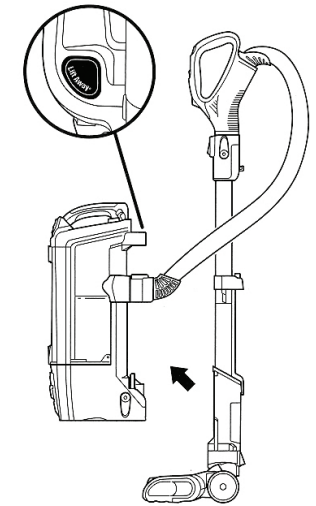

LIFT-AWAY® ABOVE-FLOOR CLEANING

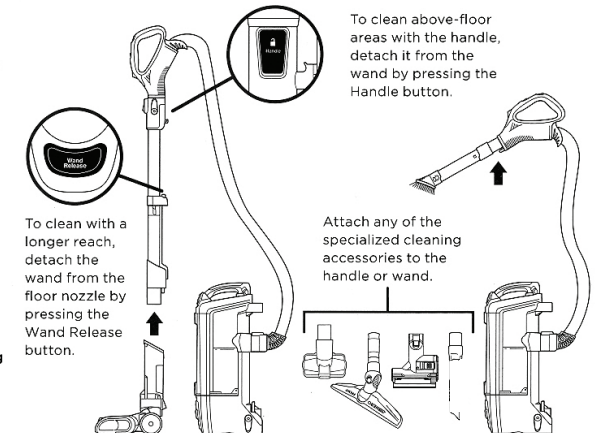

TRUEPET, LIFT-AWAY, POWERED LIFT-AWAY, and SHARK are registered trademarks of SharkNinja Operating LLC.

