

Haier

Installation and User Manual

QHNG08AA
QHNG10AA

Room Air Conditioner

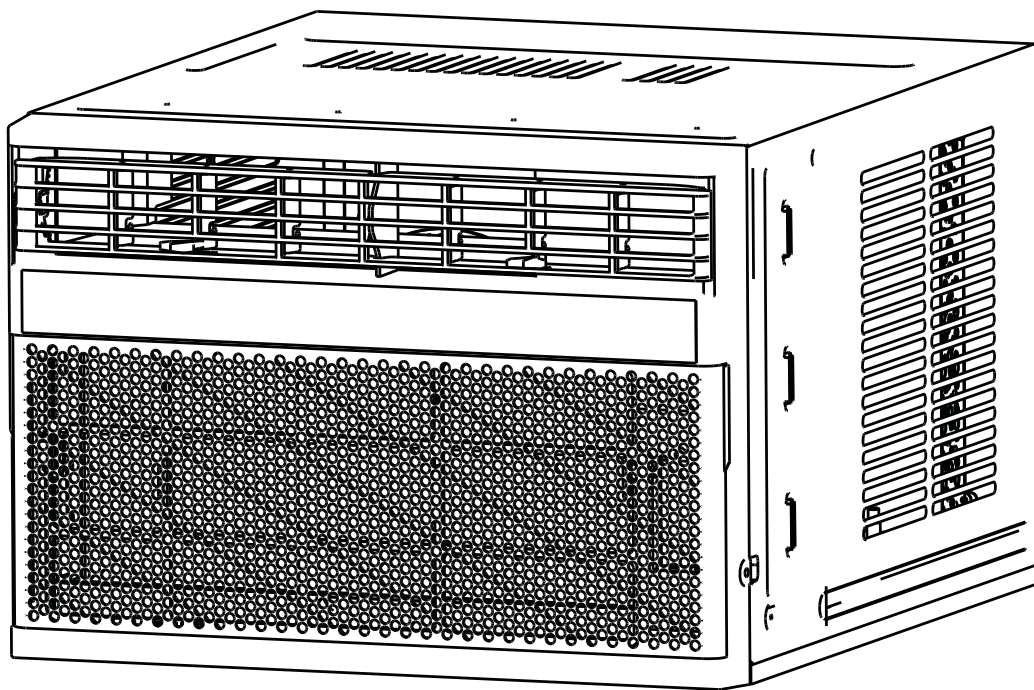

Design may vary by model number.

Some models may have an additional letter after the model number.

TABLE OF CONTENTS

SAFETY INFORMATION	4
USING THE AIR CONDITIONER	
Controls	5
Remote Control	6
Cool Mode	6
Energy Saver Mode	6
Air Direction	7
CARE AND CLEANING	
Grille and Case	7
Air Filter	7
Outdoor Coils	7
Install Batteries in Remote	7
INSTALLATION INSTRUCTIONS	
Before you begin	8
Electrical Requirements	8
Parts Included	9
Window Requirements	10
Prepare the Air Conditioner	10
Install the Air Conditioner	11
Install Support Brackets	12
TROUBLESHOOTING TIPS	13
Normal Operating Sounds	14
SmartHQ SETUP	14

SAFETY INFORMATION

⚠ WARNING

For your safety, the information in this manual must be followed to minimize the risk of fire, electric shock or personal injury.

- Use this appliance only for its intended purpose as described in this Owner's Manual.
- This air conditioner must be properly installed in accordance with the Installation Instructions before it is used.
- Never unplug your air conditioner by pulling on the power cord. Always grip plug firmly and pull straight out from the receptacle.
- Replace immediately all electric service cords that have become frayed or otherwise damaged. A damaged power supply cord must be replaced with a new power supply cord obtained from the manufacturer and not repaired. Do not use a cord that shows cracks or abrasion damage along its length or at either the plug or connector end.
- Turn the unit OFF and unplug your air conditioner before cleaning.
- For your safety...do not store or use combustible materials, gasoline or other flammable vapors or liquids in the vicinity of this or any other appliance.
- If the receptacle does not match the plug, the receptacle must be changed out by a qualified electrician.



WARNING

Risk of Fire or Explosion. This unit contains flammable refrigerant. Additional safety precautions must be followed.

- Do not use means to accelerate the defrosting process or to clean, other than those recommended by the manufacturer.
- The appliance shall be stored in a room without continuously operating ignition sources (for example: open flames, an operating gas appliance or an operating electric heater).
- Do not pierce or burn refrigerant tubing. Be aware that refrigerants may not contain an odor.
- Keep ventilation openings clear of obstruction.
- When handling, installing, and operating the appliance, care should be taken to avoid damage to the refrigerant tubing.
- Do not drill holes in the unit.
- Maintenance, cleaning, and service should only be performed by technicians properly trained and qualified in the use of flammable refrigerants.
- GE Appliances does not support any servicing of the air conditioner.
- Dispose of air conditioner in accordance with Federal and Local Regulations. Flammable refrigerants require special disposal procedures. Contact your local authorities for the environmentally safe disposal of your air conditioner.

READ AND SAVE THESE INSTRUCTIONS

CONTROLS

Features and appearance will vary.

Lights beside the touch pads on the air conditioner control panel indicate the selected settings.

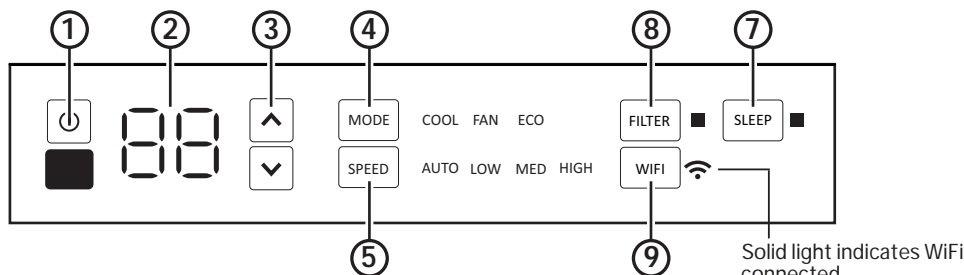

Air Conditioner Controls

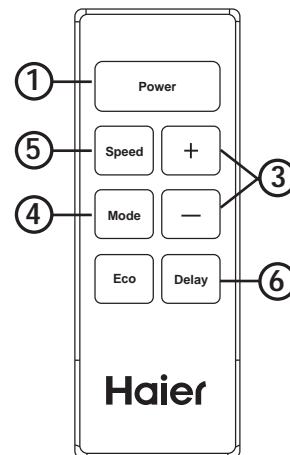

Remote Control

1. Power Pad

Turns air conditioner on and off. When turned on, the display will show the Set temperature.

2. Display

Shows the Set temperature or time remaining on the Delay timer. Shows the **Set** temperature while setting the temperature in **Cool** or **Eco** modes.

3. Temp and Delay Increase \wedge / Decrease \vee Pads

Use to set temperature or delay time. Temperature can be set in **Cool** and **Eco** mode.

4. Mode Pad

Use to set the air conditioner to **Fan Only**, **Cool**, or **Eco** mode.

5. Fan Speed Pad

In **Cool** or **Eco** mode: Use to set the fan speed to **Auto**, **High**, **Med** or **Low** on the unit.

In **Fan Only** mode: Use to set the fan speed to **High**, **Med**, or **Low** on the unit.

6. Delay Pad (set by remote control only)

Delay ON—When the air conditioner is off, it can be set to automatically come on in 1 to 24 hours at its previous mode and fan settings.

Delay OFF—When the air conditioner is on, it can be set to automatically turn off in 1 to 24 hours.

How to set:

Press the **Delay** pad on the remote control. Each touch of the **Increase \wedge / Decrease \vee** pads on the remote control will set the timer in 1-hour intervals.

To review the remaining time on the Delay timer, press the Delay pad on the remote control. Use the Increase \wedge / Decrease \vee pads on the remote control to set a new time if desired.

To cancel the timer, press Decrease \vee pad on the remote control until the set time is zero.

7. Sleep Pad (set by air conditioner controls only)

The **SLEEP** mode sets the unit to gradually change settings over an 8 hour period to allow for some increased energy efficiency during sleep hours.

The **SLEEP** mode is available only in **COOL** and **FAN** only settings.

Press the **SLEEP** mode pad and its light will illuminate. The fan indicator will stay at the same setting but the air conditioner will automatically change the **FAN** speed to low in either **COOL** or **FAN** only mode.

In **FAN** only mode, the fan will stay in the **LOW** speed setting for 8 hours. After 8 hours, the air conditioner will resume the settings that were in place before the **SLEEP** mode pad was pressed.

In **COOL** mode, the fan will stay in the **LOW** speed setting for 8 hours from the time the **SLEEP** mode pad was pressed. The air conditioner will also raise the set point 2°F in 30 minutes and 2°F more in another 30 minutes where it will remain for the next 7 hours. After 8 hours, the air conditioner will resume the settings that were in place before the **SLEEP** mode pad was pressed.

While the unit is in **SLEEP** mode, pressing any pad will return it to the settings that were in place before the **SLEEP** mode pad was pressed.

8. Filter Reset Pad

This feature automatically notifies you that the air filter must be cleaned. The indicator light will come on after 250 hours of operation. Clean the air filter, place it back in the front panel, and press the **Filter Reset** pad. The light will go off.

9. SmartHQ Pad

Enables connection of the air conditioner to the home WiFi.

Download the Haier Home App  For details go to Haierappliances.com.

USING THE AIR CONDITIONER

Do Not Operate in Freezing Outdoor Conditions

This cool-only air conditioner was not designed for freezing outdoor conditions.

It must not be used when the outdoor temperature is below freezing (32°F).

Control Panel Lights On/Off Feature

This air conditioner has a control panel lights on/off feature where its lights will turn off when there is no activity with the controls for over one minute. To wake up the controls, press any pad on the controls and the lights will come on to show the previous settings.

To turn this feature off, press and hold the **SLEEP** pad, on the unit, for 5 seconds. The unit will beep to signal the successful toggle of the feature on and off.

Remote Control

- To ensure proper operation, aim the remote control at the signal receiver on the air conditioner.
- The remote control signal has a range of up to 20 feet.
- Make sure nothing is between the air conditioner and the remote control that could block the signal.
- Make sure batteries are fresh and installed correctly as indicated on the remote control.

Cool Mode

Use the Cool mode at **Low**, **Med**, **High** or **Speed** for cooling. Use the **Temperature Increase** \wedge / **Decrease** \vee pads to set the desired temperature between 64°F and 86°F in 1°F increments.

An electronic thermostat is used to maintain the room temperature. The compressor will cycle on and off to keep the room at the set level of comfort. Set the thermostat at a lower number and the indoor air will become cooler. Set the thermostat at a higher number and the indoor air will become warmer.

NOTE: If the air conditioner is off and is then turned on while set to a **Cool** setting or if turned from a fan setting to a **Cool** setting, it may take approximately 3 minutes for the compressor to start and cooling to begin.

Cooling Descriptions

For Normal Cooling—Select the **Cool** mode and **High** or **Med** fan with a middle set temperature.

For Maximum Cooling—Select the **Cool** mode and **High** fan with a lower set temperature.

For Quieter and Nighttime Cooling—Select the **Cool** mode and **Low** fan with a middle set temperature.

Eco Mode

Controls the fan.

ON—The fan will cycle on and off with the compressor. This may result in wider variations of room temperature and humidity. **NOTE:** the fan may continue to run for a short time or may pulse intermittently after the compressor cycles off to sample the room air.

OFF—The fan runs all the time, while the compressor cycles on and off.

Fan Only Mode

Use the Fan Only Mode at **Low**, **Med** or **High** fan speed to provide air circulation and filtering without cooling. Since fan-only settings do not provide cooling, a Set temperature cannot be entered. The room temperature will appear in the display.

Auto Fan Mode

Set to **Auto** for the fan speed to automatically set to the speed needed to provide optimum comfort settings with the set temperature.

If the room needs more cooling, the fan speed will automatically increase. If the room needs less cooling, the fan speed will automatically decrease.

USING THE AIR CONDITIONER

Air Direction

Use the levers to adjust the air direction left or right. Tilt the louver bank to adjust up and down.

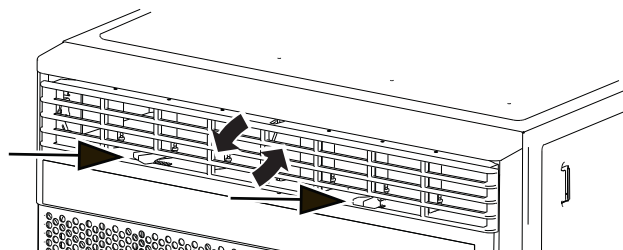

CARE AND CLEANING

Grille and Case

Turn the air conditioner off and remove the plug from the wall outlet before cleaning.

To clean, use water and a mild detergent. Do not use bleach or abrasives.

Air Filter

The air filter behind the front grille should be checked and cleaned at least every 30 days or more often if necessary.

To remove:

Open the inlet grille by pulling downward on the tabs at the top upper corners of the inlet grille until the grille is in a 45° position. Remove the filter.

Clean the filter with warm, soapy water. Rinse and let the filter dry before replacing it. Do not clean the filter in a dishwasher.

CAUTION

DO NOT operate the air conditioner without a filter because dirt and lint will clog it and reduce performance.

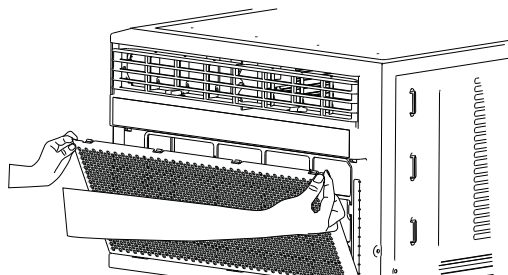

Outdoor Coils

The coils on the outdoor side of the air conditioner should be checked regularly. If they are clogged with dirt or soot, they may be professionally cleaned.

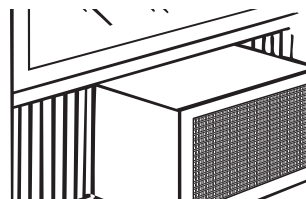

How to Insert the Batteries in the Remote Control (Batteries Not Included)

1. Remove the battery cover by sliding it according to the arrow direction.
2. Insert new batteries, making sure that the (+) and (-) of battery are installed correctly.
3. Reattach the cover by sliding it back into position.

NOTES:

- Use 2 "AAA" (1.5 volt) batteries. Do not use rechargeable batteries.
- Remove the batteries from the remote control if the system is not going to be used for a long time.
- Do not mix old and new batteries. Do not mix standard (carbon-zinc) or rechargeable (ni-cad, ni-mh, etc) batteries.

INSTALLATION INSTRUCTIONS

BEFORE YOU BEGIN

Read these instructions completely and carefully.

- **IMPORTANT** – Save these instructions for local inspector's use.
- **IMPORTANT** – Observe all governing codes and ordinances.
- **Note to Installer** – Be sure to leave these instructions with the Consumer.
- **Note to Consumer** – Keep these instructions for future reference.
- **Skill level** – Installation of this appliance requires basic mechanical skills.
- **Completion time** – Approximately 1 hour
- We recommend that two people install this product.
- Proper installation is the responsibility of the installer.
- Product failure due to improper installation is not covered under the Warranty.
- You **MUST** use all supplied parts and use proper installation procedures as described in these instructions when installing this air conditioner.

ELECTRICAL REQUIREMENTS



These models require a 115/120-volt AC, 60-Hz grounded outlet protected with a 15-amp time-delay fuse or circuit breaker.

The 3-prong grounding plug minimizes the possibility of electric shock hazard. If the wall outlet you plan to use is only a 2-prong outlet, it is your responsibility to have it replaced with a properly grounded 3-prong wall outlet.

⚠ CAUTION

Do not, under any circumstances, cut or remove the third (ground) prong from the power cord.

Do not change the plug on the power cord of this air conditioner.

Aluminum house wiring may present special problems—consult a qualified electrician.

ELECTRICAL REQUIREMENTS (cont)

Power cord includes a current interrupter device. A test and reset button is provided on the plug case. The device should be tested on a periodic basis by first pressing the **TEST** button and then the **RESET** button while plugged into the outlet. If the **TEST** button does not trip or if the **RESET** button will not stay engaged, discontinue use of the air conditioner and contact a qualified service technician.

TOOLS YOU WILL NEED (NOT INCLUDED)

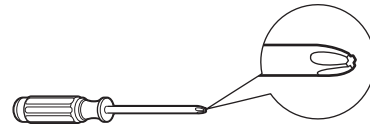

Phillips head screwdriver

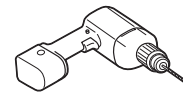

Drill and 1/8" drill bit



Pencil

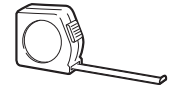

Ruler or tape measure



Level



Scissors or knife

INSTALLATION INSTRUCTIONS

PARTS INCLUDED (Appearance may vary)

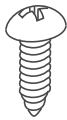
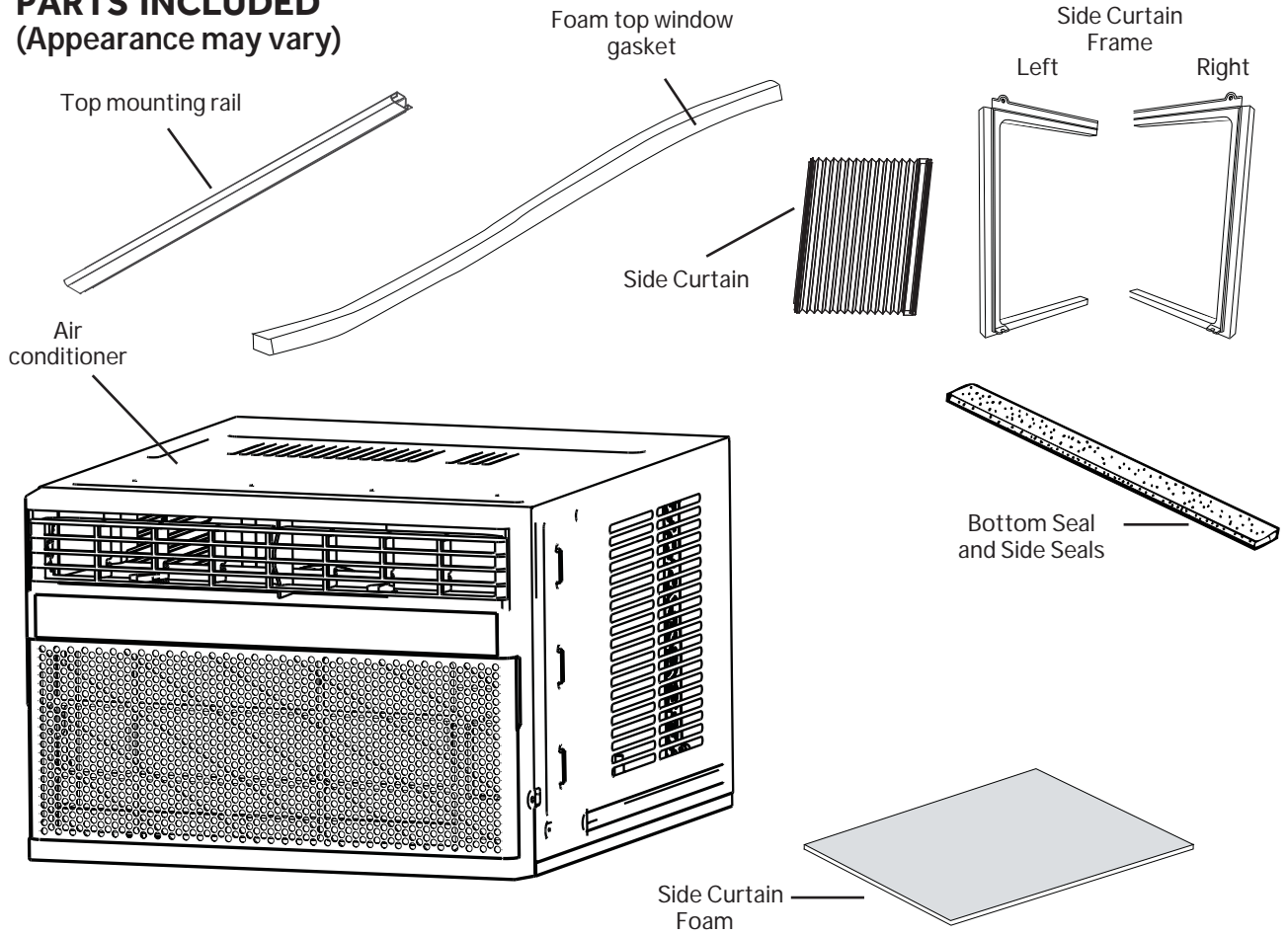

Type A

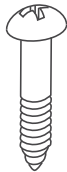

Type B

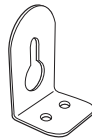

Side Brackets



Window locking bracket

• Accessory type and quantity may vary depending on the model.

INSTALLATION INSTRUCTIONS

1. WINDOW REQUIREMENTS

- These instructions are for a standard double-hung window. You will need to modify them for other types of windows.
- The air conditioner can be installed without the side curtain panels if needed to fit in a narrow window. See the window opening dimensions.
- All supporting parts must be secured to firm wood, masonry or metal.
- The electrical outlet must be within reach of the power cord.
- Follow the dimensions in the table and illustration for your model.

Models	A	B
QHNG08	15 1/16" min	24" - 38"
QHNG10	15 5/8" min	26 1/8" - 37 3/4"

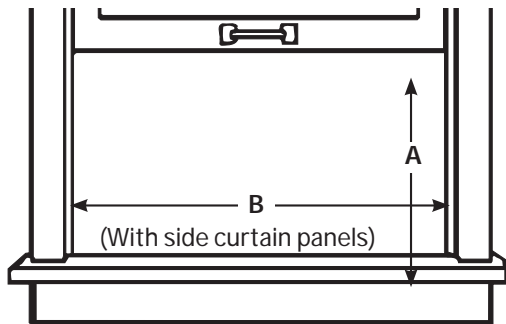

2. STORM WINDOW REQUIREMENTS

A storm window frame will not allow the air conditioner to tilt toward the outside, and will keep it from draining properly. To adjust for this, attach a piece of wood to the sill.

WOOD PIECES

WIDTH: 2"

LENGTH: Long enough to fit inside the window frame.

THICKNESS: To determine the thickness, place a piece of wood on the sill to make it 1/2" higher than the top of the storm window frame or the vinyl frame.

Attach securely with nails or screws provided by the installer.

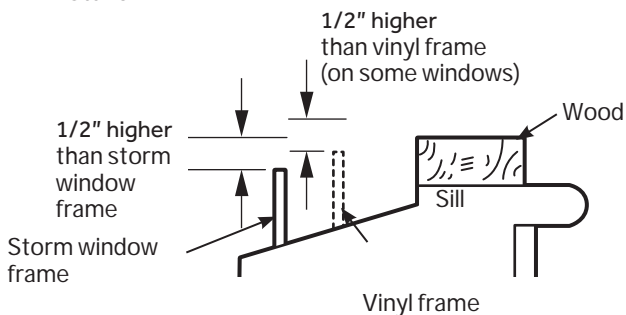

3. PREPARE THE AIR CONDITIONER

- A.** Install the top mounting rail with Type A screws, 4 for AHH10 and 3 for AHH08, from the outside of the case.

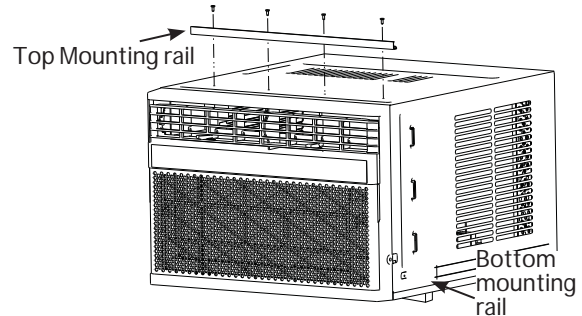

- B.** Apply the weather seals provided to the bottom, top and sides of the window to the seal around the perimeter of the air conditioner.

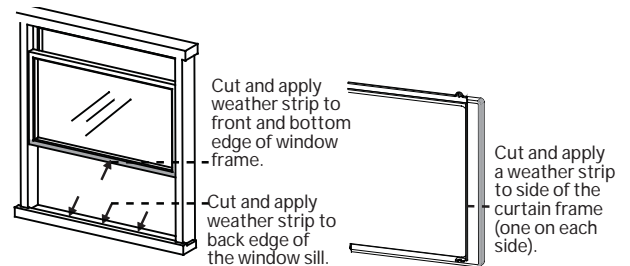

- C.** Slide the side curtain panels into the side panel rails.

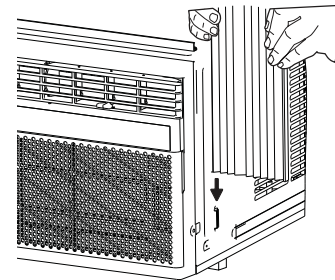

- D.** Slide left and right side curtain frames into top and bottom rails. Make sure that side curtains snap into side of the frames.

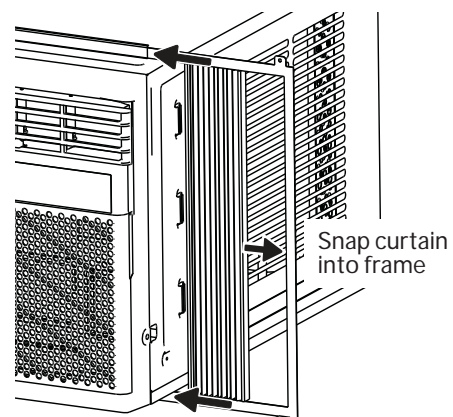

INSTALLATION INSTRUCTIONS

4. INSTALL THE AIR CONDITIONER IN THE WINDOW

- A. Mark the center of the window. Set the air conditioner in the window so that it is centered. Place the air conditioner so that front edge of the bottom mounting rail is against the back edge of the sill.
- B. Bring the window down so that the front edge of the top mounting is in front of the window. Make sure that the air conditioner is level or tilting slightly to the outside.

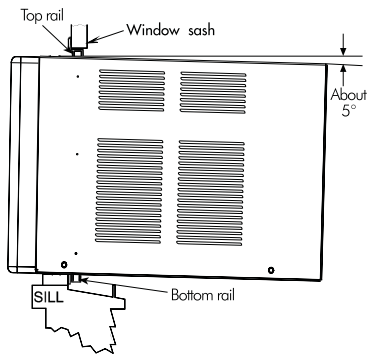

- C. Extend the curtain panels until they fill the window. Mark the location of the holes in each corner. Use the drill and 1/8" drill bit to drill pilot holes. Use 4 type B screws to secure the side panels in place.

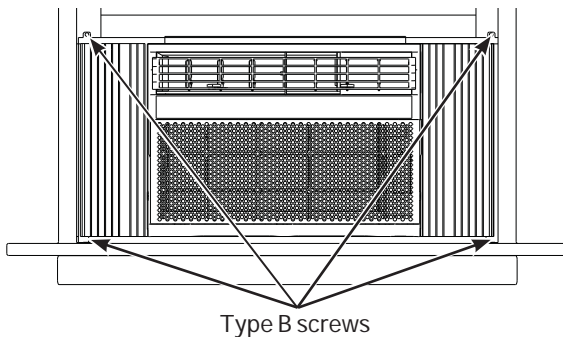

5. SECURE AIR CONDITIONER

- A. Loosen the screw on the right hand side of the air conditioner near the bottom.
- B. Slide a side bracket over the screw so that the bracket is resting on the window sill. Tighten the screw.

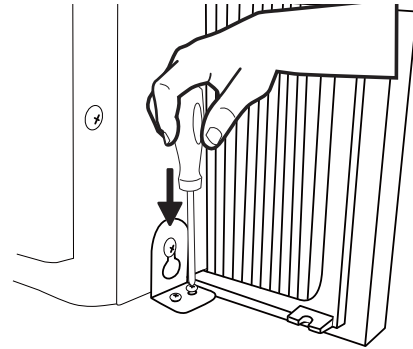

- C. Use a 1/8" drill bit to drill a starter hole into the window sill through the holes in the side bracket. Use 4 type B screws to attach the side bracket to the window sill.
- D. Repeat the side bracket installation on the left side.
- E. Measure and cut adhesive foam backed sheet. Apply over side curtain and frame.

INSTALLATION INSTRUCTIONS

6. INSTALL WINDOW LOCK BRACKET AND FOAM TOP WINDOW GASKET

Use Type B Screw to install the window lock bracket on top of the bottom window.

A. **CAUTION**

To prevent broken glass or damage to windows, on vinyl or other similarly constructed windows, attach the window locking bracket to the window side jamb with one Type B screw.

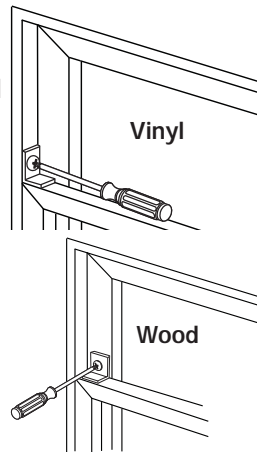

B. Cut the foam top window gasket to the window width.

C. Stuff the foam between the glass and the window to prevent air and insects from getting into the room.

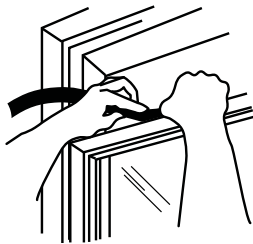

NOTE: If the gasket not supplied does not fit your window, obtain appropriate material locally to provide a proper installation seal.

TROUBLESHOOTING

Save time and money! Review the charts on the following.

Problem	Possible Cause	What To Do
Air conditioner does not start.	The unit is unplugged.	Make sure the air conditioner plug is pushed completely into the outlet.
	The fuse is blown/circuit breaker is tripped.	Check the house fuse/circuit breaker box and replace the fuse or reset the breaker.
	Power Failure.	The unit will automatically restart in the setting last used after the power is restored. There is a protective time delay (approximately 3 minutes) to prevent tripping of the compressor overload. For this reason, the unit may not start normal cooling for 3 minutes after it is turned back on.
	The current interrupter device is tripped.	Press RESET button located on the power cord plug. If the RESET button will not stay engaged, discontinue use of the air conditioner and contact a qualified service technician.
Air conditioner does not cool as it should.	Indoor airflow is restricted.	Make sure there are not curtains, blinds or furniture blocking the front of the air conditioner.
	The temp control may not be set properly.	Turn the temperature control to a higher number.
	The air filter is dirty.	Clean the filter at least every 30 days. See Care and Cleaning section.
	The room may have been hot.	When the air conditioner is first turned on, you need to allow time for the room to cool down.
	Cold air is escaping.	Check for open furnace registers and cold air returns.
	Cooling coils have iced up.	See "Air conditioner freezing up" below.
Air conditioner freezing up	Ice blocks the air flow and stops the air conditioner from cooling the room.	Set the mode control to High Fan or High Cool with the temperature setting as high as it can be set.
Water drips outside	Hot, humid weather.	This is normal.
Water drips inside	The air conditioner is not tilted to the outside.	For proper disposal, make sure the air conditioner slants slightly from the case front to the rear.
Water collects in base pan	Moisture removed from air and drain into base pan.	This is normal for a short period in areas with little humidity; normal for a longer period in very humid areas.

NORMAL OPERATING SOUNDS

- You may hear a pinging noise caused by water being picked up and thrown against the condenser on rainy days or when the humidity is high. This design feature helps remove moisture and improve efficiency.
- You may hear the thermostat click when the compressor cycles on and off.
- Water will collect in the base pan during high humidity or on rainy days. The water may overflow and drip from the outdoor side of the unit.
- The fan may run even when the compressor does not.
- Water droplets being thrown against the outside coils can make a pinging noise. This helps cool the condenser. You can reduce this noise by removing the subbase water plug.

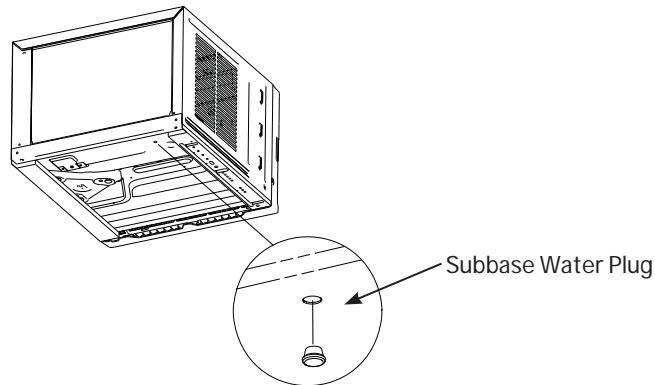

Removing this plug will lower the Energy Efficiency of your unit.

NOTE: Do not drill hole in the base pan.

WIFI SETUP

Haier SmartHQ (for customers in the United States)

Haier SmartHQ Enabled*. If your Air Conditioner (AC) has a Connected Appliance Information label located on the outside as shown below, your AC is **Haier Appliances SmartHQ Enabled**. A WiFi communication card is built into the product allowing it to communicate with your smart phone for remote monitoring, control and notifications.

Please download the Haier Home App . For details go to Haierappliances.com to learn more about connected appliance features, and to learn what connected appliance apps will work with your smart phone.

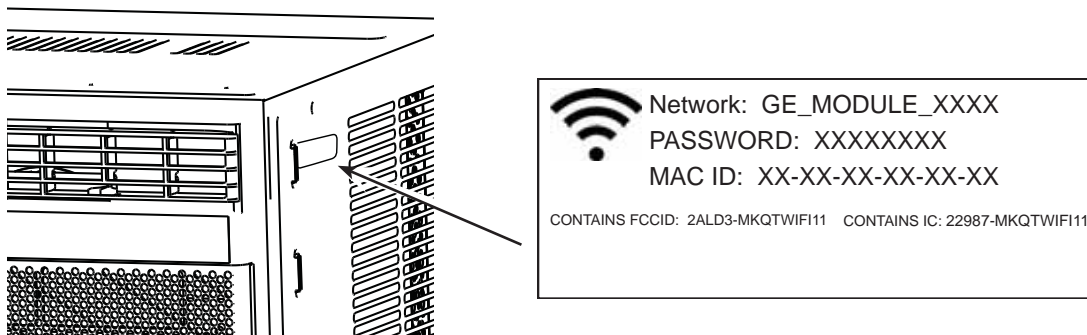

WiFi Connectivity: For assistance with the appliance or the **ConnectPlus** network connectivity (for models that are WiFi enabled or WiFi optional), please **contact a service center**.

SMARTHQ SETUP

How it Works

Download the SmartHQ App



Use the app to connect your room air conditioner to WiFi



Once connected, use the app to turn down your air conditioner as you leave work.

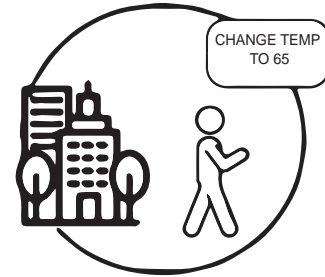

Getting Started

To connect your room air conditioner, you'll need the SmartHq App. The app will walk you through the connection process. Download the app from iTunes or Google Play.



All connected appliance data is held in strict accordance with the Haier Appliances Connected Data Privacy Policy. Visit geappliances.com/privacy/privacy_policy_connected to view this policy.

Questions about SmartHQ

Get answers you need about setting up WiFi appliances and connecting to your home network in our support articles.

Visit products.geappliances.com/appliance/gea-support-search-content to view SmartHQ room air conditioner support articles.

REGULATORY INFORMATION

FCC/IC Compliance Statement:

This device complies with Part 15 of the FCC Rules. Operation is subject to the following two conditions:

1. This device may not cause harmful interference.
2. This device must accept any interference received, including interference that may cause undesired operation.

This equipment has been tested and found to comply with the limits for a Class B digital device, pursuant to Part 15 of the FCC Rules. These limits are designed to provide reasonable protection against harmful interference in a residential installation. This equipment generates uses and can radiate radio frequency energy and, if not installed and used in accordance with the instructions, may cause harmful interference to radio communications. However, there is no guarantee that interference will not occur in a particular installation. If this equipment does cause harmful interference to radio or television reception, which can be determined by turning the equipment off and on, the user is encouraged to try to correct the interference by one or more of the following measures:

- Reorient or relocate the receiving antenna.
- Increase the separation between the equipment and receiver.
- Connect the equipment into an outlet on a circuit different from that to which the receiver is connected.
- Consult the dealer or an experienced radio/television technician for help.

Labelling: Changes or modifications to this unit not expressly approved by the manufacturer could void the user's authority to operate the equipment.

*Select Models Only

This product has Wi-Fi capability and requires Internet connectivity and a wireless router to enable interconnection with an Energy Management System, and/or with other external devices, systems or applications.

804106461



PRINTED IN MEXICO Elbrd: J.E.
OBPN: 49-5000537 Rev.1 11-20 GEA
SC: 10-20-2023 MODEL: QHNG10AA_B