



## COFFEE MAKER

Instructions for use. Keep these instructions

ELECTRIC CHARACTERISTICS

115 V~ 60 Hz 1500 W



\*Please read this manual carefully before operating your unit and retain for future reference.

NOTE: In order to ensure the highest possible standard for refurbished items, all units are thoroughly inspected as part of the process.

For this item, water may be used during the refurbishing process and so; you may notice some condensation in the water reservoir. It is recommended to rinse the water reservoir with fresh water prior to its first use.

---

814100085

**Note:** The image shown here is for illustrative purposes only and may be subject to change. The actual number of accessories may vary depending on the model.

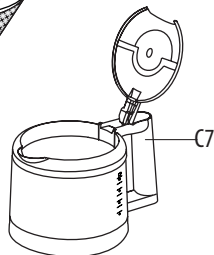
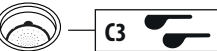
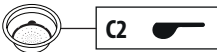
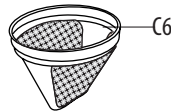
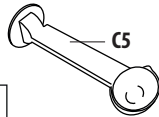
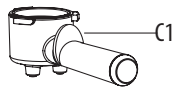
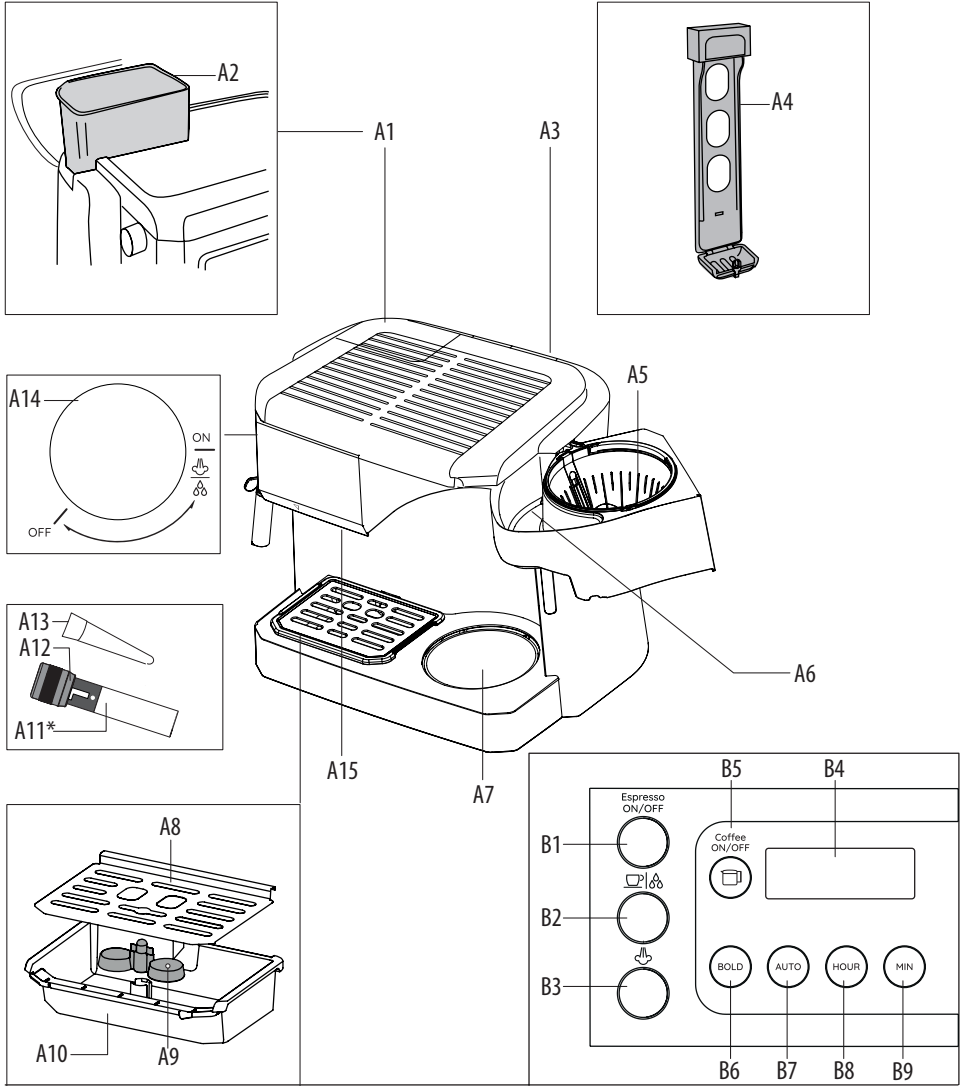

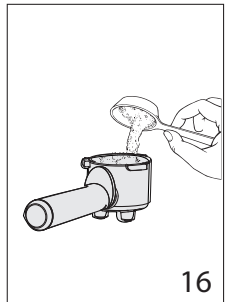
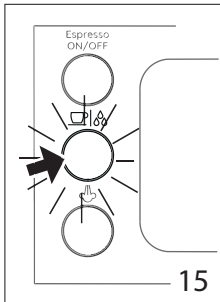
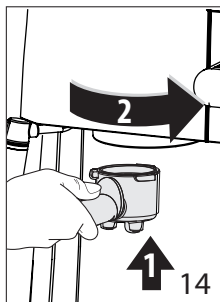
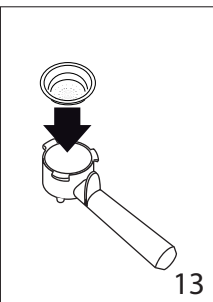
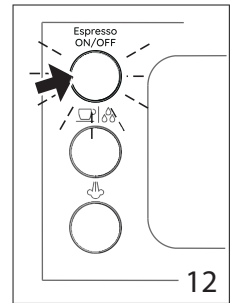
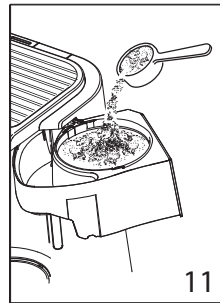
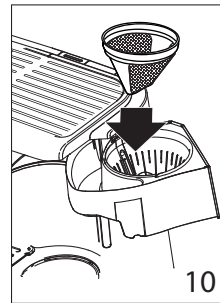
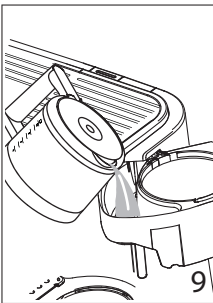
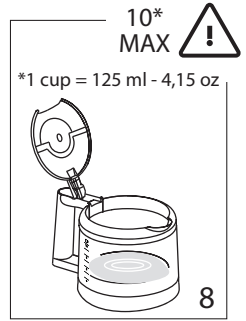
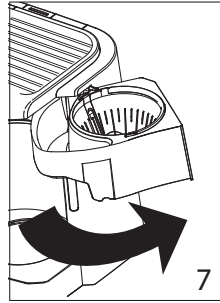
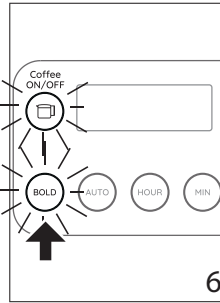
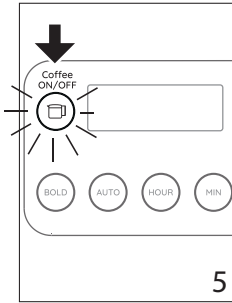
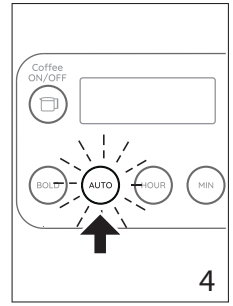
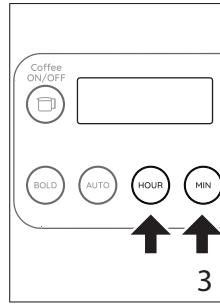
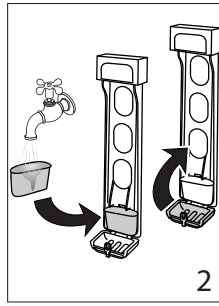
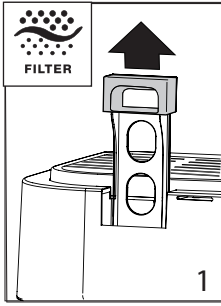

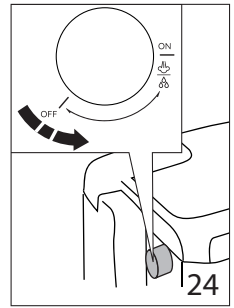
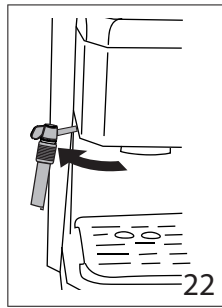
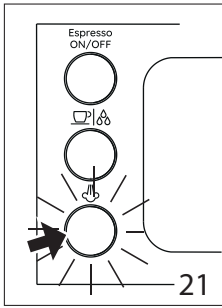
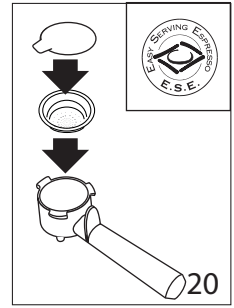
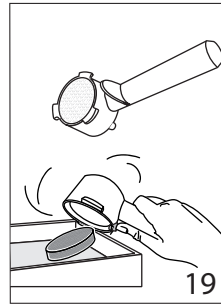
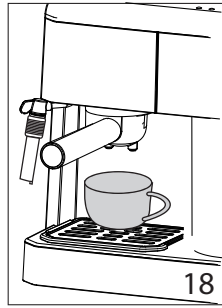
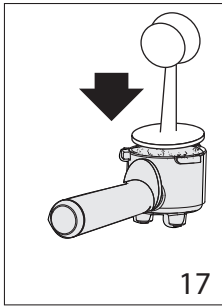

### Adjustable Capuccino system\*

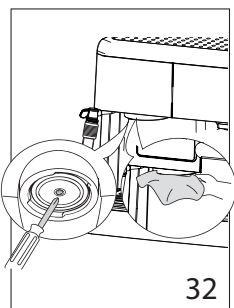
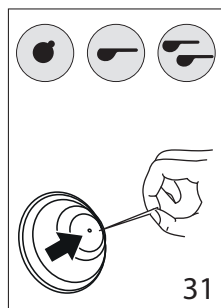
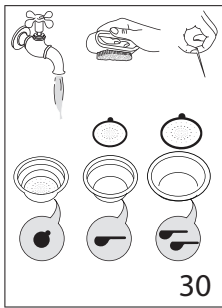
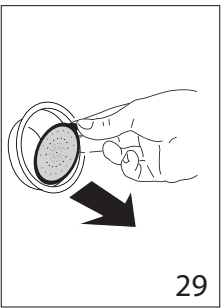
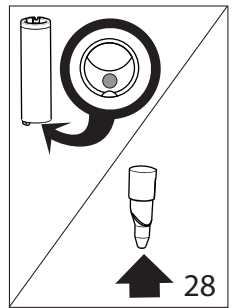
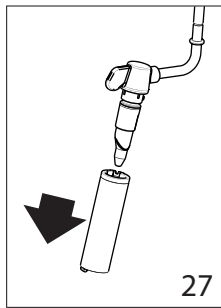
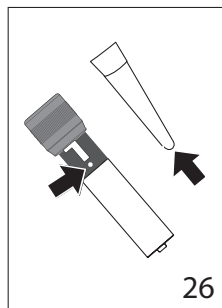
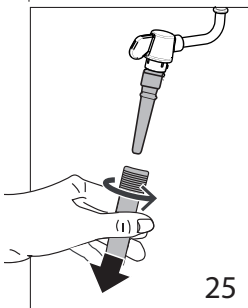

\*The images shown here are for illustrative purposes only and may be subject to change.

# 1. IMPORTANT SAFEGUARDS

---

When using electrical appliances, basic safety precautions should always be followed, including the following:

- Read all instructions.
- Do not touch hot surfaces. Use handles and knobs.
- To protect against fire, electrical shock and personal injury, do not immerse cord, plug or appliance in water or other liquid.
- Never allow the appliance to be used by children.
- Unplug from the outlet when not in use and before cleaning. Allow to cool before fitting or taking off parts, and before cleaning the appliance.
- Do not operate with a damaged cord or plug, or after the appliance malfunctions, or has been damaged in any manner.
- The use of accessory attachments or spare parts not recommended by the appliance manufacturer may result in fire, electrical shock or personal injury.
- Do not use outdoors.
- Do not let the cord hang over the edge of the table or counter, or touch hot surfaces.
- Do not place on or near a hot gas or electrical burner, or in a heated oven.
- Plug cord into the wall outlet. To disconnect, turn any control to "off", then remove plug from wall outlet.
- Do not use the appliance for other than the intended use. This appliance is to be utilized for domestic use only. Any other use is to be considered improper and, therefore, dangerous.
- For machines with glass carafe:
  - A. The carafe is an accessory to be used exclusively with this appliance. Never use it on a cooking surface.
  - B. Do not set the hot container on a damp or cold surface.
  - C. Do not use the carafe if it is cracked or the handle is not completely sturdy.
  - D. Do not use abrasive detergents or sponges to clean.

**WARNING: To reduce the risk of fire or electric shock, do not remove the cover.**

## SAVE THESE INSTRUCTIONS

THIS PRODUCT IS FOR HOUSEHOLD USE ONLY

# 2. SHORT CORD INSTRUCTIONS

---

- A short power cord is provided to reduce risks resulting from becoming entangled in or tripping over a longer cord.
- Longer, detachable power supply cords or extension cords are available and may be used if care is exercised in their use.
- If an extension cord is used, the marked electrical rating should be at least as great as the electrical rating of the appliance. If the appliance is provided with 3- wire, grounding type cord, the extension should be a GROUNDING TYPE 3 - WIRE CORD. The longer cord should be arranged so that it will not drape over the counter-top or table top where it can be pulled on by children or tripped over.
- Your product is equipped with a polarized alternating current line plug (a plug having one blade wider than the other). This plug will fit into the power outlet only one way. This is a safety feature. If you are unable to insert the plug fully into the outlet, try reversing the plug. If the plug should still fail to fit, contact your electrician to replace your obsolete outlet. Do not defeat the safety purpose of the polarized plug.

**Read this instruction booklet carefully before installing and using the machine. This is the only way to ensure the best results and maximum safety for the user.**

---

### **3. SAFETY WARNINGS**

- This machine is designed to “make coffee” and “hot drinks”. Use with care to avoid scalds from the water and steam jets or through incorrect use.
- Never touch hot parts.
- After removing the packaging, make sure the product is complete. If in doubt, do not use the machine and contact a service center.
- The packing elements (plastic bags, polystyrene foam, etc.) should be kept out of reach of children as they are a safety hazard.
- This machine is intended for domestic use only. Any other use is considered improper and thus dangerous.
- The manufacturer cannot be held responsible for any damage caused through incorrect, wrong or unreasonable use.
- Never touch the machine with wet or damp hands.
- Never let children use the machine without supervision.
- Never allow children to play with the machine.
- Should the machine break or not function correctly, turn it off and do not tamper with it. For all repairs, contact authorized service centers only and insist on the use of original spare parts. Failure to respect the above could reduce the safety of the machine.
- The power cord for this machine must not be replaced by the user as this operation requires the use of special tools. In the event of damage, contact an authorized service center only to avoid all risks.

### **4. DESCRIPTION**

The terminology below will be used on subsequent pages.

#### **4.1 Description of the machine**

- A1. Espresso water tank lid
- A2. Espresso removable water tank
- A3. Antichlorine filter extraction handle
- A4. Antichlorine filter support
- A5. Filter-holder for drip coffee
- A6. Water fill compartment
- A7. Drip coffee warming plate
- A8. Espresso cup tray
- A9. Drip tray water level indicator
- A10. Drip tray
- A11. Frother
- A12. Frother selection ring (Adjustable Cappuccino System only)
- A13. Steam connection nozzle (COM532)
- A14. Steam dial for cappuccino
- A15. Boiler outlet

### **4.2 Description of control panel**

#### **Espresso section**

- B1. “Espresso ON/OFF” button with integrated light
- B2. Espresso coffee/hot water button with integrated light
- B3. Steam button with integrated light

#### **Drip coffee section**

- B4. Display
- B5. “Coffee ON/OFF” button
- B6. BOLD button
- B7. AUTO button
- B8. HOUR button
- B9. MIN button

### **4.3 Description of the accessories**

- C1. Espresso portafilter
- C2. One-cup espresso filter
- C3. Two-cups espresso filter
- C4. Filter for espresso pods
- C5. Coffee measuring scoop with tamper
- C6. Permanent gold tone filter
- C7. Drip Coffee Carafe

### **4.4 Installation**

- Place the machine on a work surface away from water faucets and sinks.
- Check that the voltage of the outlet corresponds to the value indicated on the machine rating plate. Connect the machine to an efficiently grounded electrical socket with a minimum rating of 10A only. The manufacturer declines all liability for any accidents caused by the absence of an efficient ground system.
- If the plug fitted to the machine does not match the electrical socket, have the outlet replaced with a suitable type by a qualified electrician.
- Never install the machine in environments where the temperature may reach 0°C (32°F) or lower (the machine may be damaged if the water freezes).



## 5. FIRST USE

When using the machine **for the first time**, all the accessories and the internal circuits must be washed as follows:

### DRIP COFFEE MAKER:

- Run the coffee machine without using ground coffee for 2 full cycles.

### ESPRESSO MAKER:

- Open the lid and remove the water tank.
- Fill the water tank up to the max level.
- Insert the water tank in its housing by pushing the water tank down until the bottom and close the lid (it is also possible to fill the tank using a carafe).
- Insert the required coffee filter in the portafilter and attach the empty portafilter onto the machine.
- Place a large container under the spouts (34 fl/oz, 1l capacity).
- Press the “Espresso ON/OFF” and  buttons and discharge half the tank from the boiler outlet.
- Turn the steam dial to  and discharge the remaining water from the cappuccino maker then turn the steam dial back to OFF.
- Empty the container and put it back under the spouts and proceed with a second rinse.

## 6. PREPARATION OF DRIP COFFEE

### 7.1 Setting the clock

When the coffee machine is connected to the outlet for the first time, “AM 0:00” will flash on the display.

To set the time, proceed as follows:

1. Press and hold the “HOUR” button (Fig. 3) for three seconds until the number of hours flashes on the display.
2. Before the display stops flashing (about 5 seconds), set the hour by pressing the “HOUR” button repeatedly.
3. Set the minutes by pressing the “MIN” button (Fig. 3) repeatedly. (To speed up the operation, hold the button

down.)

4. After setting the time, wait 5 seconds. When the display stops flashing, the time set is saved.  
To reset the time, press and hold the HOUR button for three seconds, and then follow the procedure as described starting from point 2.

**Please note:** In the event of a temporary power failure, the time set does not remain saved in the memory.

## 7 Programming the automatic start (AUTO BUTTON)

The machine can be programmed to make drip coffee automatically. First, make sure that the time is set correctly.

To set the delayed start (i.e. the time you want the coffee to be made), proceed as follows:

1. Press and hold the AUTO button (Fig. 4) for about three seconds until 0:00 flashes on the display.
2. Before the display stops flashing (about 5 seconds), set the desired hour by pressing the “HOUR” button repeatedly.
3. Set the minutes by pressing the “MIN” button repeatedly.
4. After 5 seconds, the display will stop flashing and the programmed time will be saved.
5. After you have programmed the machine as described above, just press the AUTO button to have coffee made at the time set (The AUTO Button will turn illuminated and will stay illuminated).

**Please note:**

- If you want to change the start time after it has been set, press the AUTO button for about 2 seconds and then set a new time as described starting from point 2.
- Keep in mind that at the time set, the machine will start to make drip coffee only. The espresso maker does not come on.
- To cancel the automatic start, you have to press the Auto button again (it will turn off and will not stay illuminated).

### 7.1 Keep warming set

The machine is factory-set to keep the coffee warm for two hours after brewing.

However, this setting can be changed as follows:

1. Press and hold the “Coffee ON/OFF” button (Fig. 5) for three seconds until 0:00 flashes on the display.
2. Modify the time by repeatedly pressing the HOUR button (and also the MIN button if required).
3. After setting the time, wait 5 seconds. When the display stops flashing, the time will be saved.

**Please note:** If 0:00 is set, the machine switches off. (You can set a time between 1 minute and 11 hours and 59 minutes).

## 7.2 Making drip coffee

- Open the filter-holder door, rotating it towards the right (fig. 7).
- Fill the carafe to the level indicator relative to number of cups of coffee you wish to prepare, taking care not to exceed the MAX level of 10 cups (fig. 8), otherwise, in order to not overflow the machine, the excess water will spill out from the back of the unit.
- Then pour the water into the water-fill compartment of the machine (fig. 9).
- Position the gold tone filter into the filter-holder (fig. 10).
- Put the ground coffee in the filter using the measuring spoon supplied and level it off evenly (fig. 11). As a general rule, use a level measure of coffee (approx 7 grams) for every cup of coffee required (for example, 10 measures to obtain 10 cups).
- Close the filter-holder door and place the carafe, with cover in place, onto the warming plate.
- Press the “Coffee ON/OFF” button. The button illuminates to indicate that the drip coffee-maker is brewing.
- The coffee will begin to dispense after a short time.

It is perfectly normal for the machine to emit steam while the coffee is percolating.

To keep the coffee hot after the unit is finished percolating it will automatically switch to keep warm for up to the selected time.

- To turn off the machine press the “Coffee ON/OFF” button.

**Please note:** At the end of coffee dispensing the appliance emits a beep.

## 7.3 “BOLD” function

The Bold function enhances the flavor of your coffee. This feature activates a unique brewing process, slowly releasing water into the filter basket; saturating coffee grounds a little at a time extracting the best flavor and aroma from your coffee.

To activate, press the “BOLD” button after having pressed the “Coffee ON/OFF” button (fig. 6); the button will illuminate. Press the button again to turn the selection off.

This function is recommended when preparing 1 to 4 cups. Do not use this button if brewing an entire carafe of coffee.

You can select this function even when using the auto function (see paragraph 7.2).

If you want to activate the bold function for delayed brewing, after you program the timer you need to activate the bold function by pressing the button.

## 8. ESPRESSO

### 8.1 Preheating the espresso unit

To make espresso coffee at the right temperature, the coffee maker should be preheated as follows:

1. Press the “Espresso ON/OFF” button (fig. 12) to turn the machine on. The integrated light flashes to indicate that the machine is heating up.
2. Insert the filter to the portafilter (fig. 13). Attach the portafilter with filter to the machine (fig. 14) without adding pre-ground coffee.
2. Place a cup under the portafilter. Use the same cup that will be used to prepare the coffee in order to preheat it.
3. Wait until the “Espresso ON/OFF” integrated light stops flashing: now the machine is ready to make espresso.
4. Press the ☐/☉ button (fig. 15). Continue delivering water until you fill the cup and then interrupt the delivery by pressing the same button and empty the cup.

#### **Please note:**

- It is normal for a small and harmless puff of steam to be given off when removing the portafilter.
- Never operate the appliance without water in the tank or without the tank.

## 8.2 How to make espresso using pre-ground coffee

1. Preheat the machine and portafilter as described in the previous paragraph.
2. Place the ground coffee filter in the portafilter. To make one espresso, use the filter with the ☐ symbol on the bottom, to make two espressos, use the filter with the ☉ symbol on the bottom.
3. To make just one espresso, place one level measure with the scoop provided of pre-ground coffee (about 7 g/0,25 oz) in the filter (fig. 16). To make two espressos, place two level measured scoops with the scoop provided.



#### **Important:**

For correct operation, before filling with pre-ground coffee, make sure there are no coffee residues left in the filter from the last time you made coffee.

4. Distribute the pre-ground coffee evenly and press with the tamper (fig. 17).  
Correct pressing of the pre-ground coffee is essential to obtain a good espresso. If pressing is excessive, coffee delivery will be slow and the crema will be dark. If pressing is too light, coffee delivery will be too fast and the crema will be weak and light in color.
5. Remove any excess coffee from the rim of the portafilter and attach to the machine. Turn as far as it will go (fig. 14) to avoid water leaking out.
6. Place the cup or cups under the portafilter spouts (fig. 18). You are recommended to warm the cups before making coffee by rinsing them with a hot water.
7. Make sure the “Espresso ON/OFF” integrated light is solid (if



it flashes wait until it stops), then press the ☐/☞ button (fig. 15). When the desired amount of espresso has been delivered, press the same button to interrupt the flow.

8. To remove the portafilter, turn the handle from right to left.



### **Danger of burns!**

To avoid splashes, never remove the portafilter while the machine is delivering coffee.

9. To dispose of the used coffee empty the grounds by turning the portafilter upside down and tapping it firmly (fig. 19).
10. To turn the machine off, press the “Espresso ON/OFF” button.

## **How to prepare espresso using pods**

1. Preheat the machine as described in the section “PREHEATING THE COFFEE UNIT (8.1)”, making sure the portafilter is attached. This obtains a hotter coffee.



### **Please note:**

Use pods conforming to the ESE standard, indicated on the pack by the following symbol.



The ESE standard is a system accepted by leading pod producers and enables espresso to be prepared simply and cleanly.

2. Place the filter for espresso pods (with the ● symbol on the bottom) in the portafilter (fig. 13).
3. Insert the pod, centering it as far as possible on the filter (fig. 20). Always follow the instructions on the pod pack to position the pod on the filter correctly.
4. Attach the portafilter to the machine. Always turn as far as it will go (fig. 14).
5. Proceed as in points 6, 7 and 8 in the previous section.

## **9. HOW TO MAKE CAPPUCCINO OR LATTE**

1. Prepare the espresso as described in the previous sections, using sufficiently large cups. Ensure that the unit is on by pressing the Espresso On/off button.
2. Press the ☞ button: the integrated light flashes to indicate that the machine is heating up (fig. 21).
3. In the meantime, fill a pitcher with about 3.5 oz/100 grams for each cappuccino or 6 oz/170 grams for each latte to be prepared. In choosing the size of the pitcher, keep in mind that the milk doubles or triples in volume.



### **Please note:**

It is recommended to use whole or 2% milk at refrigerator temperature.

4. **Models with Adjustable Cappuccino System only:**

Make sure the ring on the cappuccino maker is positioned downwards in the CAPPUCCINO position and place the pitcher containing the milk under the cappuccino maker.

5. Wait until the ☞ light stops flashing to indicate that the boiler has reached the ideal temperature for steam production. As the boiler heats up, it is normal for a little water and steam to be given off into the drip tray.
6. Extract the frother by rotating to the left (fig. 22). During this operation, avoid touching the boiler outlet as it is hot. Then place the milk pitcher under the frother.
7. Make sure the frother is immersed in the milk. (fig. 23). Turn the steam dial counterclockwise to the ☐/☞ ON position (fig. 24). Steam is delivered from the frother, giving the milk a creamy frothy texture. For a creamier froth, immerse the frother in the milk and move the container with slow up/down movements.
8. When the required temperature (the ideal is 60°C/140°F) and froth density is reached, interrupt steam delivery by turning the steam dial clockwise to the OFF position and press the ☞ button.
9. Pour the frothed milk into the cups containing the espresso prepared previously. The cappuccino is ready.



### **Please note:**

- To prepare more than one cappuccino, first make all the espressos then at the end prepare the frothed milk for all the cappuccinos.
- To make espresso again after the milk has been frothed, cool down the boiler first or the espresso will be burnt. To cool the boiler, place a container under the boiler outlet, press the ☐/☞ button and deliver water until the “Espresso ON/OFF” flashes. Then prepare the espresso as described previously.
- **Clean the frother every time you use it, to avoid milk residue or clogging.**

You are recommended to deliver steam for a maximum of 60 seconds and never to froth milk more than three times consecutively.

## **10. MAKING HOT MILK (WITHOUT FROTH) (ONLY SOME MODELS)**

To make hot milk without froth, proceed as described in the previous section, making sure the ring on the frother is positioned upwards in the “HOT MILK” position.

## **11. CLEANING THE FROTHER AFTER USE**



### **Important:**

For hygiene and performance reasons, the frother should always

be cleaned after each use.

Proceed as follows:

1. Deliver a little steam for a few seconds by turning the steam dial counterclockwise (fig. 24). This causes the frother to discharge any milk left inside. Turn the machine off by pressing the "Espresso ON/OFF" button.
2. With one hand, hold the frother spout firmly, with the other, release the frother by turning it counterclockwise, then pull off downwards (fig. 27).
3. Remove the steam connection nozzle from the spout by pulling it downwards.
4. Wash the frother and steam connection nozzle thoroughly with warm water.
5. Make sure the two holes shown by the arrows in fig. 28 are not blocked. If necessary, clean with a pin.
6. Put the steam connection nozzle back, pressing forcefully upwards to insert it onto the steam tube.
7. Replace the frother by pushing upwards and turning clockwise.

## 12. HOT WATER

1. Press the "Espresso ON/OFF" button (fig. 12) to turn the machine on, the integrated light flashes to indicate that the machine is heating up.
2. In the meantime, place a mug under the frother.
3. "Espresso ON/OFF" integrated light stops flashing, press the ☐/☞ button (fig. 15) and at the same time turn the steam dial counterclockwise to ☐/☞ ON (fig. 24). Water comes out of the frother.
4. To interrupt hot water delivery, press the ☐/☞ button again and turn the steam dial clockwise to OFF.

You should not deliver hot water for more than 60 seconds.

## 13. CLEANING



### **Danger!**

- While cleaning, never immerse the coffee maker in water. It is an electrical machine.
- Before cleaning the outside of the machine, turn it off, unplug from the mains socket and allow to cool.

### 13.1 Cleaning the drip tray



#### **Important!**

The drip tray is fitted with a level indicator (red) showing the level of water it contains. As soon as the indicator begins to protrude from the cup tray, the drip tray must be emptied and cleaned, otherwise the water may overflow the edge and damage the

machine, the surface it rests on or the surrounding area.

1. Remove the drip tray.
2. Remove the cup tray, empty the water and clean the drip tray with a cloth, then reassemble the drip tray.
3. Put the drip tray back in place.

### 13.2 Espresso filter cleaning and maintenance

Clean the coffee filters weekly:

#### 1 and 2 cup filters

1. Extract the perforated filter by pulling the tab (fig. 29);
2. Rinse the filters under running water (fig. 30);
3. Make sure the holes are not blocked. If necessary, clean with a pin (figs. 30 and 31);
4. Place the perforated filter in the filter housing and press as far as it will go.

#### Pod filter

Rinse under running water. Make sure the holes are not blocked. If necessary, clean with a pin (figs. 30 and 31).

### 13.3 Cleaning the boiler outlet

About every 300 espressos, the boiler outlet must be cleaned as follows:

- Make sure the machine is not hot and that it is unplugged from the mains;
- Use a screwdriver to release the screw fixing the espresso boiler outlet (fig. 32);
- Remove the boiler outlet;
- Clean the boiler with a damp cloth (fig. 32);
- Clean the outlet thoroughly with hot water using a brush. Make sure the holes are not blocked. If necessary, clean with a pin.
- Rinse under running water, brushing all the time.
- Replace the boiler outlet, making sure it is correctly positioned on its gasket.

Failure to clean as described above voids the warranty.

### 13.4 Other cleaning operations

1. Do not use solvents or abrasive detergents to clean the coffee maker. Use a soft damp cloth only.
2. Clean the portafilter, filters and water tank regularly.



#### **Danger!**

While cleaning, never immerse the coffee maker in water. It is an electrical machine.

## 14. DESCALING



Over time, calcium in the water may cause obstructions, reducing the efficiency of the coffee maker.

### 14.1 Descaling the espresso unit

It is recommended to descale the espresso maker when the descaling notification flashes (the steam button  (B3) will emit a double flashing light) and this will occur with every 200 espressos that are brewed. This notification will not prevent any function.

The notification could be temporarily postponed by pressing the espresso side push buttons. At the end of the next brew cycle, if descaling has not been completed, the notification will flash on the steam button. We recommend using commercially available De'Longhi descaler.

Proceed as follows:

1. Pour into the tank the descaling product following the instructions in the package. Fill the tank with water up to the "max" level for the correct dilution.
2. The "Espresso ON/OFF" button (fig. 12) light should be kept OFF.
3. Make sure the portafilter is not attached and position a bowl under the boiler outlet.
4. Press and hold the steam button  (B3) for at least 6 sec. This will start the automated Descaling Process.
5. While the machine starts dispensing water, open once steam knob 2-3 seconds to discharge a little water from the frother system.  
The clock will switch to a countdown (27 min) during the process and will revert back after the end of descaling. The steam button (B3) will blink until the end of descaling.
6. To eliminate residues of solution and scale, rinse the tank well, then fill it again with fresh water (without descaler).
7. Press the  button (fig. 15) and deliver water until the tank is completely empty.  
While the machine starts dispensing water, open once steam knob 2-3 seconds to discharge a little water from the frothing system.
8. Repeat operations 6 and 7 again.

If descaling is not performed regularly as required, the warranty will be void if the repair is a result of damage to the coffee maker due to limescale.

### 14.2 Descaling the drip coffee unit

It is recommended to descale the coffee maker when the descaling notification flashes (the Bold LED button will emit a double flashing light) and this will occur with every 40 coffees that are brewed. This notification will not prevent any function.

The notification could be temporarily postponed by touching any touch icon of the drip side.

At the end of the next brew cycle, if descaling has not been completed, the notification will flash on the BOLD LED.

We recommend using commercially available DeLonghi descaler.

1. Remove the antichlorine filter and pour into the tank the descaling product following the instructions in the package;
2. Fill the tank with water up to the "max" level for the correct dilution;
3. Place the carafe on the warming plate;
4. Press and hold the "BOLD" touch icon for at least 6 seconds to start the "descaling" cycle.
5. During the descaling cycle the "BOLD" led will blink. The clock will switch to a countdown (27 min) during the process and will blink until the end of descaling.
6. Rinse at least 3 times by operating the machine with water only (i.e. as in 7.5, but without coffee)

## 15. TROUBLESHOOTING

Below is a list of some of the possible malfunctions.

If the problem cannot be resolved as described, contact a Service Center.

PROBLEM	POSSIBLE CAUSE	SOLUTION
No espresso is delivered	No water in the tank	Fill the tank with water
	The holes in the filter holder are blocked	Clean the filter holder spout holes
	The espresso boiler outlet is blocked	Clean as described in the section "13.3 Cleaning the boiler outlet"
	Scale/hard water deposits in the water circuit	Perform the descaling procedure as described in the section "14.1 Descaling the espresso unit"
	The tank is not correctly in place and the valve on the bottom is not open	Press the tank down lightly to open the valve on the bottom
The espresso coffee drips from the edges of the filter holder rather than the holes	The filter holder is inserted incorrectly	Attach the filter holder correctly and rotate firmly as far as it will go
	The holes in the filter holder spouts are blocked	Clean the spout holes.
The pump is excessively noisy	The water tank is empty	Fill the tank
	The tank is not correctly in place and the valve on the bottom is not open	Press the tank down lightly to open the valve on the bottom
The espresso is cold	The "Espresso ON/OFF" integrated light was flashing when the coffee button was pressed	Wait until the "Espresso ON/OFF" integrated light stop flashing
	No preheating was done	Preheat as described in the section "8.1 Preheating the coffee unit"
	The cups were not preheated	Heat the cups by rinsing them in hot water
	Scale/hard water deposits in the water circuit	Perform the descaling procedure as described in the section "14.1 Descaling the espresso coffee unit"
The espresso crema is too light (delivered from the spout too fast)	The pre-ground coffee is not pressed down firmly enough	Press the pre-ground coffee down more firmly (fig. 18)
	There is not enough pre-ground coffee	Increase the quantity of pre-ground coffee
	The pre-ground coffee is too coarse	Use only pre-ground coffee for espresso makers
	The wrong type of pre-ground coffee is being used	Change the type of pre-ground coffee

PROBLEM	POSSIBLE CAUSE	SOLUTION
The espresso crema is too dark (delivered from the spout too slowly)	The pre-ground coffee is pressed down too firmly	Press the coffee down less firmly (fig. 17)
	There is too much pre-ground coffee	Reduce the quantity of pre-ground coffee
	The espresso boiler outlet is blocked	Clean as described in the section "13.3 Cleaning the boiler outlet".
	The pre-ground coffee is too fine or damp	Use pre-ground coffee for espresso coffee makers only and make sure it is not too damp
	The wrong type of pre-ground coffee is being used	Use a different type of pre-ground coffee
The filter holder cannot be attached to the appliance	Too much coffee has been placed in the filter	Use the measuring scoop included and make sure you are using the correct filter for the type of preparation
No milk froth is formed when making cappuccino	Milk not cold enough	Always use semi-skimmed milk at refrigerator temperature
	Milk frother not clean	Thoroughly clean the holes in the cappuccino maker, in particular those indicated in fig. 26-28
	<b>Models with adjustable cappuccino sytem (COM532):</b> The ring of cappuccino maker in not in the cappuccino position	Place the ring in the cappuccino position
The drip or espresso has an acid flavor	Inadequate rinsing after descaling	Rinse the appliance as described in the section "14.1 Descaling the espresso coffee unit" or "14.2 Descaling the drip coffee unit"
The drip coffee takes longer to percolate	The drip coffee maker needs to be descaled	Perform the descaling procedure as described in the section "14.2 Descaling the drip coffee unit"
Steam button double flashes	Descaling is required for espresso	
The steam button is blinking	Descaling is in process	
The BOLD LED is double flashing	Descaling is required for the drip coffee unit	
BOLD led blinking	Descaling is in process	

