



ESPRESSO MAKER

ELECTRIC CHARACTERISTICS

120 V~ 60 Hz 1100 W

IMPORTANT SAFEGUARDS

When using electrical appliances, basic safety precautions should always be followed, including the following:

- Read all instructions.
- Do not touch hot surfaces. Use handles and knobs.
- To protect against fire, electrical shock and personal injury, do not immerse cord, plug or appliance in water or other liquid.
- Never allow the appliance to be used by children.
- Unplug from the outlet when not in use and before cleaning. Allow to cool before fitting or taking off parts, and before cleaning the appliance.
- Do not operate with a damaged cord or plug, or after the appliance malfunctions, or has been damaged in any manner.
- The use of accessory attachments or spare parts not recommended by the appliance manufacturer may result in fire, electrical shock or personal injury.
- Do not use outdoors.
- Do not let the cord hang over the edge of the table or counter, or touch hot surfaces.
- Do not place on or near a hot gas or electrical burner, or in a heated oven.
- Plug cord into the wall outlet. To disconnect, turn any control to "off", then remove plug from wall outlet.
- Do not use the appliance for other than the intended use. This appliance is to be utilized for domestic use only. Any other use is to be considered improper and therefore, dangerous.

WARNING: To reduce the risk of fire or electric shock, do not remove the exterior of the unit or the cover.

SAVE THESE INSTRUCTIONS

THIS PRODUCT IS FOR HOUSEHOLD USE ONLY

SHORT CORD INSTRUCTIONS

- A short power cord is provided to reduce risks resulting from becoming entangled in or tripping over a longer cord.
- Longer, detachable power supply cords or extension cords are available and may be used if care is exercised in their use.
- If an extension cord is used, the marked electrical rating should be at least as great as the electrical rating of the appliance. If the appliance is provided with 3-wire, grounding type cord, the extension should be a GROUNDING TYPE 3 - WIRE CORD. The longer cord should be arranged so that it will not drape over the counter-top or table top where it can be pulled on by children or tripped over.
- Your product is equipped with a polarized alternating current line plug (a plug having one blade wider than the other). This plug will fit into the power outlet only one way. This is a safety feature. If you are unable to insert the plug fully into the outlet, try reversing the plug. If the plug should still fail to fit, contact your electrician to replace your obsolete outlet. Do not defeat the safety purpose of the polarized plug.

1. DESCRIPTION OF THE APPLIANCE

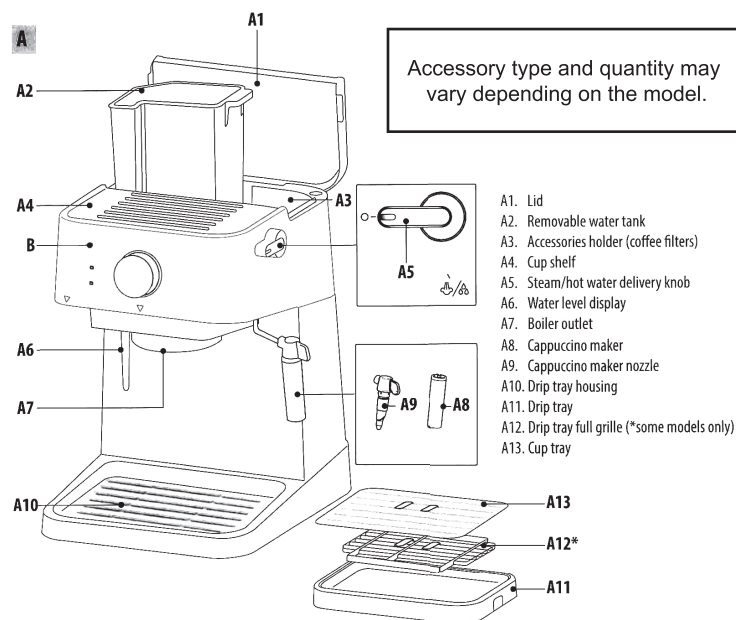

2. DESCRIPTION OF THE CONTROL PANEL

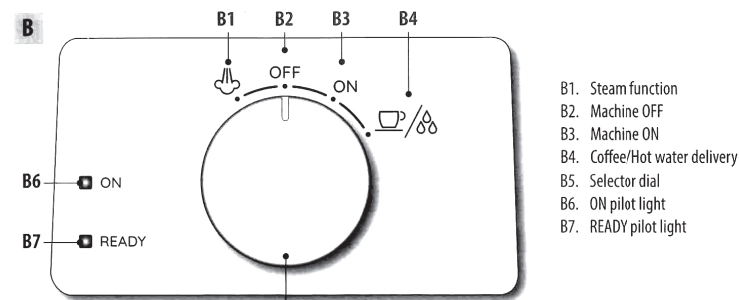

The actual number of ports may have a different name or location.

3. DESCRIPTION OF THE ACCESSORIES

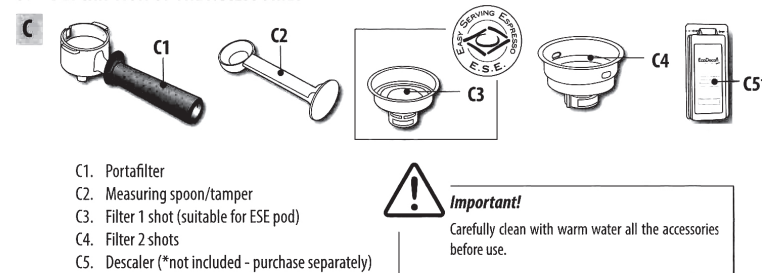

4. FIRST USE

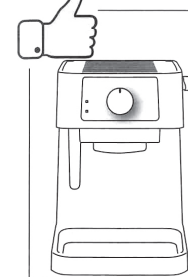
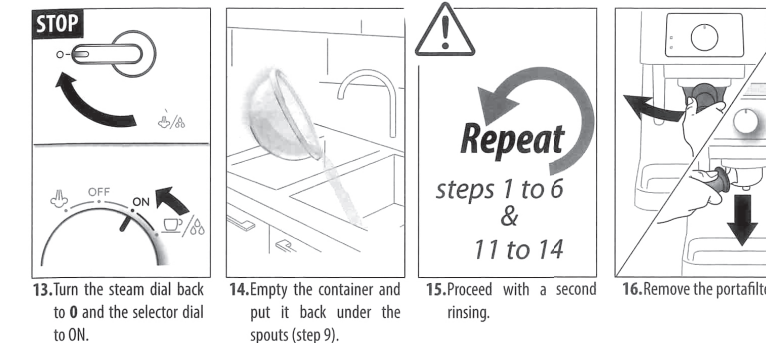
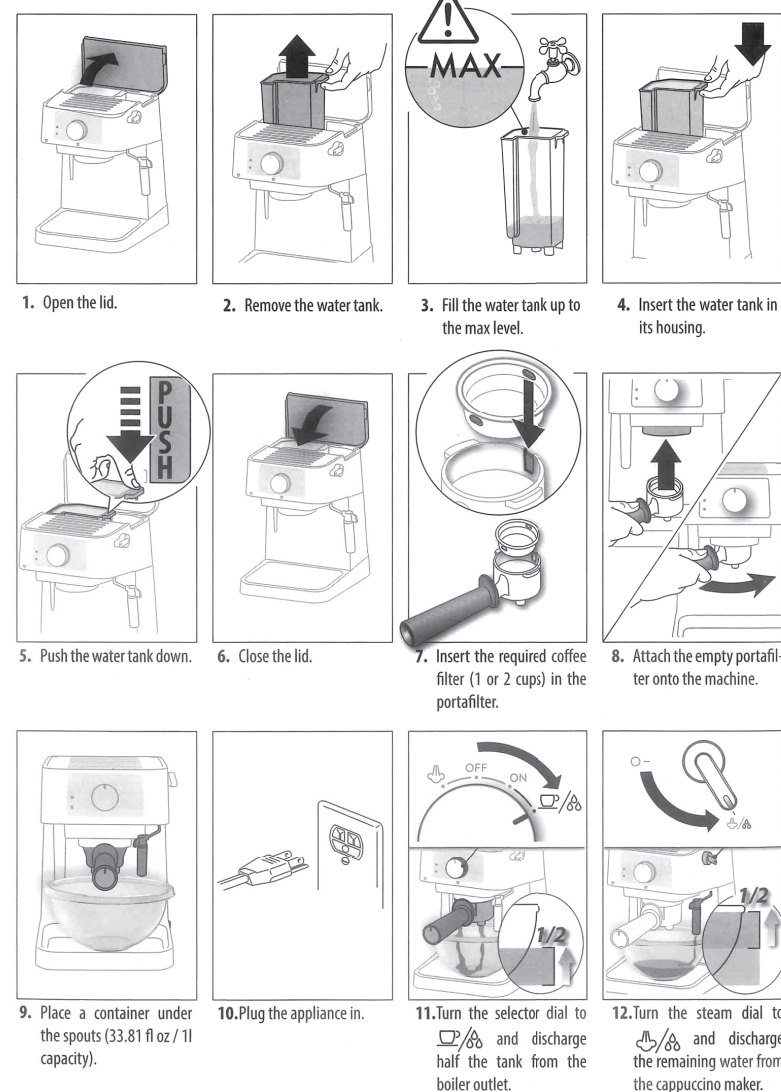

Please note:

- **No water is delivered or the pump is too noisy:** make sure the tank is filled and placed correctly and repeat the operation until water is delivered. Make sure the water tank is pushed all the way down
- Never operate the appliance without water in the tank or without the tank. Check the water level in the water tank by the display (A6).
- **Refilling the water tank:** the water tank can also be filled without extracting it, by pouring the water directly from a jug.
- When making several coffees in a row, wait about 6 minutes every 6 preparations.

5. MAKE ESPRESSO COFFEE

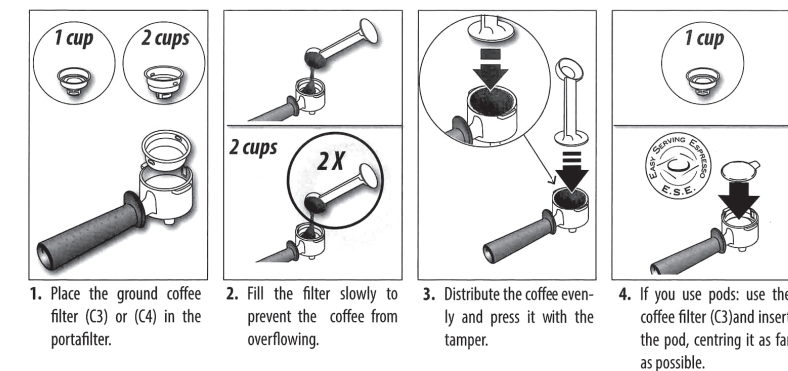

5. MAKE ESPRESSO COFFEE

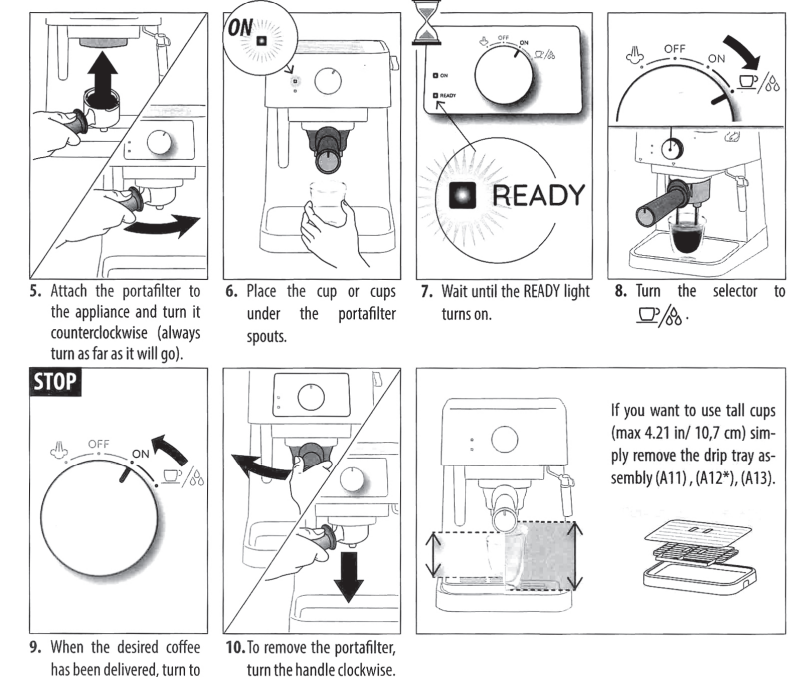

The image shown here is for illustrative purposes only and may be subject to change.

5.1 Tips for a hotter coffee

To make espresso coffee at the right temperature, the coffee maker should be preheated as follows:

- Turn the appliance on by turning the selector dial to ON (the ON light turns on) and attach the portafilter onto the appliance without adding pre-ground coffee;
- Place a cup under the portafilter. Use the same cup to be used later to prepare the coffee, in order to preheat it;
- Wait until the READY light turns on and immediately afterwards turn the selector dial to ☐/☉ and deliver water until the READY light turns off, then stop it by turning the dial to ON.
- Empty the cup, wait until the READY light turns on again and then repeat the operation.

(It is normal for a small and harmless puff of steam to be given off when removing the portafilter).

6. MAKE CAPPUCCINO

1. Prepare the espresso coffee as described in the previous sections.
2. Turn the selector to ☐/☉ and wait until the READY light turns on.
3. Fill a jug with about 3.38 fl.oz. of milk for each cappuccino to be prepared.
4. Place the jug under the cappuccino maker.
5. Turn the steam dial to ☐/☉. The milk now starts to increase its volume and becomes creamy.
6. Interrupt steam delivery by turning the dial to ☐/☉ and turn the selector to ON.
7. Pour the frothed milk into the cups containing the espresso coffee prepared previously.
8. Cappuccino is ready.

6.1 Tips for milk beverages

- For best results, the milk must be at refrigerator temperature (not hot!). You are recommended to use 2% milk.
- In choosing the size of the jug, bear in mind that the milk doubles or triples in volume once steamed.
- To prepare more than one cappuccino, make all the coffees first then at the end froth the milk for all the cappuccinos.
- To make coffee again after the milk has been frothed, first cool down the boiler, or the coffee will be burnt. To cool it down place a container under the boiler outlet, turn the selector to ☐/☉ and discharge water until the READY light goes off. Return the selector to ON and then proceed making coffee.

6.2 Cleaning the cappuccino maker after use

- Discharge a little of hot water from the cappuccino maker (step 5 of section "6. HOW TO MAKE CAPPUCCINO").
- Wait for a few minutes to allow the steam spout to cool down.
- Unscrew the cappuccino maker by turning it clockwise and wash it thoroughly with warm water.
- Remove the nozzle by pulling it downwards.
- Make sure the holes are not clogged. If necessary, clean them with a pin.
- Reposition the nozzle and the cappuccino maker back on the steam nozzle, turning it and pushing it upwards until it is attached.

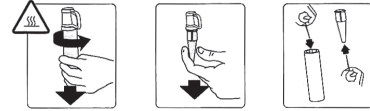

7. HOT WATER

1. Turn the selector dial to ON. Wait for the READY indicator light to turn on.
2. Place a cup under the cappuccino maker.
3. Turn the dial to ☐/☉ and at the same time, rotate the steam dial to ☐/☉.
4. Hot water is delivered from the cappuccino maker.

NOTE: In order to ensure the highest possible standard for refurbished items, all units are thoroughly inspected as part of the process. For this item, water may be used during the refurbishing process and so; you may notice some condensation in the water reservoir. It is recommended to rinse the water reservoir with fresh water prior to its first use.

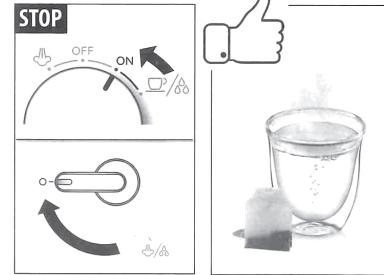

5. To stop delivery, turn the selector to ON and rotate the steam dial to 0.
6. Hot water is ready.

STOP
You should not deliver hot water for more than 60 seconds.

8. CLEANING

- Do not use solvents, abrasive detergents or alcohol to clean the coffee machine.
- Do not use metal objects to remove encrustations or coffee deposits as they could scratch metal or plastic surfaces.
- **Danger!** While cleaning, never immerse the coffee maker in water. It is an electrical appliance.
- If the appliance is not used for more than 3/4 days, before using it again, we strongly recommend you to rinse the internal circuits through, as described in section "4. FIRST USE".

8.1 Cleaning the drip tray

- Remove the tray.
- Remove the cup grille, empty the water and clean the tray with a cloth, then reassemble the drip tray.
- Put the drip tray assembly back in place.

8.2 Cleaning the coffee filters

- Rinse the filters after each use. Clean the filters thoroughly every 200 cups of coffee.
- Remove the filter from the portafilter.
1. Remove the filter cap by unscrewing in the direction indicated by the arrow on the cap.

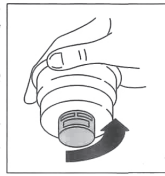

2. Disassemble all the components and rinse them with fresh water.
3. Rinse the filters under running water.
4. Clean the perforated filter with a brush. Make sure the holes are not clogged. If necessary, clean with a pin.
5. Reassemble the components making sure to insert the pin on the plastic disk into the hole in the gasket indicated by the arrow.
6. Screw the cap on.
7. Clean with a cloth. The filter is ready.

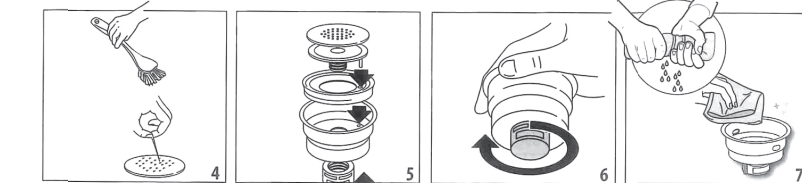
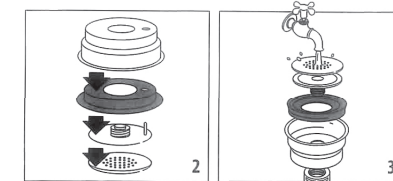

9. DESCALING

We recommend descaling the coffee maker about every 200 coffees using the De'Longhi descaler (purchase separately).

1. Fill the tank with the descaler solution, dilute the descaler with water up to the max level of the tank.
 2. Turn the selector dial to ON.
 3. Make sure the portafilter is not attached, and place a container under the cappuccino maker (1l capacity).
 4. Wait until the READY light turns on.
 5. Turn the selector to ☐/☉.
 6. Descaling starts: deliver about 1/4 of descaling solution (up to the first mark on the water level display).
 7. From time to time, turn the steam dial to ☐/☉ to discharge steam.
 8. Then interrupt delivery by turning the steam dial back to 0 and the selector dial to ON.
- Repeat points 5 to 8 another 3 times, until the tank is empty;



Then proceed rinsing the circuits:

- To eliminate residues of descaler solution, carefully rinse the tank and fill it with clean water (without descaler);
- Turn the selector to ☐/☉ and deliver water until the tank is empty: from time to time turn the steam dial to ☐/☉ to discharge steam.
- Repeat rinsing again: now the machine is ready for use.

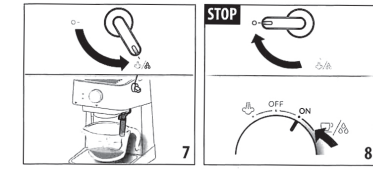

10. TROUBLESHOOTING

PROBLEM	POSSIBLE CAUSE	SOLUTION
The grounds are very damp	You haven't added enough ground coffee	Add more coffee
	Ground coffee is not tamped enough	Press the ground coffee more
No coffee is delivered	No water in the tank	Fill the tank with water
	Filter is dirty	Clean the filter ("8.2 Cleaning the coffee filters")
	Limescale in the water circuit	Descale as described in section "9. Descaling"
The coffee drips from the edges of the portafilter rather than from the holes	The portafilter has been inserted incorrectly or it is dirty	Attach the portafilter correctly and rotate firmly as far as it will go
	The holes of the portafilter spouts are clogged	Clean the portafilter spout holes
	The espresso boiler gasket has lost elasticity or it is dirty	Have the espresso boiler gasket replaced by Customer Services
The coffee is cold	The READY light is not on when coffee delivery is selected	Wait until the READY light turns on
	No preheating was done	Pre-heat the machine as indicated in section "5.1 Tips for a hotter coffee"
	The cups were not preheated	Pre-heat the cups as indicated in section "5.1 Tips for a hotter coffee"
Limescale in the water circuit		Descale as described in section "9. Descaling"
No crema on the espresso	The coffee is too old	Use freshly ground coffee
	The coffee is not suitable for espresso	Use finer ground coffee
	There is too little coffee in the filter	Add ground coffee
	Ground coffee is not tamped enough	Press the ground coffee more
The pump is excessively noisy	The water tank is empty	Fill the tank
	The tank is not correctly positioned	Press the tank down lightly to open the valve on the bottom
	There are air bubbles in the tank connector	Follow the instructions of section "7. Hot water" until water is delivered
The water tank leaks when carried	The valve at the bottom of the tank is dirty or defective	Clean the water tank
	The valve is blocked by limescale	Descale your machine according to the instructions in the user manual
The espresso leaks over the edges of the filter	The portafilter is not positioned correctly	Put the portafilter in place and lock it (turning it counterclockwise as far as it will go)
	The rim of the portafilter is encrusted with coffee grounds	Remove excessive coffee grounds and clean the grid through which water passes with a damp sponge
	The soft capsule is positioned incorrectly	Check that the soft capsule has been inserted correctly: the paper must not protrude out of the filter
The coffee is dripping too slowly (delivered from the spout too slowly)	The coffee is pressed down too firmly	Press the coffee down less firmly
	There is too much coffee	Reduce the quantity of coffee
	The filter is clogged	Clean the filter ("8.2 Cleaning the coffee filters")
	The coffee is too fine or damp	Use only pre-ground coffee for espresso coffee makers and make sure it is not damp
The wrong type of pre-ground coffee is being used		Use a different type of pre-ground coffee
The coffee has an acid taste	Inadequate rinsing after descaling	After descaling rinse the appliance as indicated in section "9. Descaling"
No milk froth is formed when making cappuccino	Milk not cold enough	Always use 2% milk at refrigerator temperature.
	Cappuccino maker dirty	Clean the cappuccino maker ("6.2 Cleaning the cappuccino maker after use")
	Limescale in the water circuit	Descale as described in section "9. Descaling"

