



COFFEE MAKER

Instructions for use. Keep these instructions

ELECTRIC CHARACTERISTICS

120 V~ 60 Hz 1300 W

The DeLonghi logo is presented in its characteristic oval shape with a black border and white background. The word "DeLonghi" is written in a bold, black, sans-serif font.

** Please read this manual carefully before using your unit and keep it for future reference **

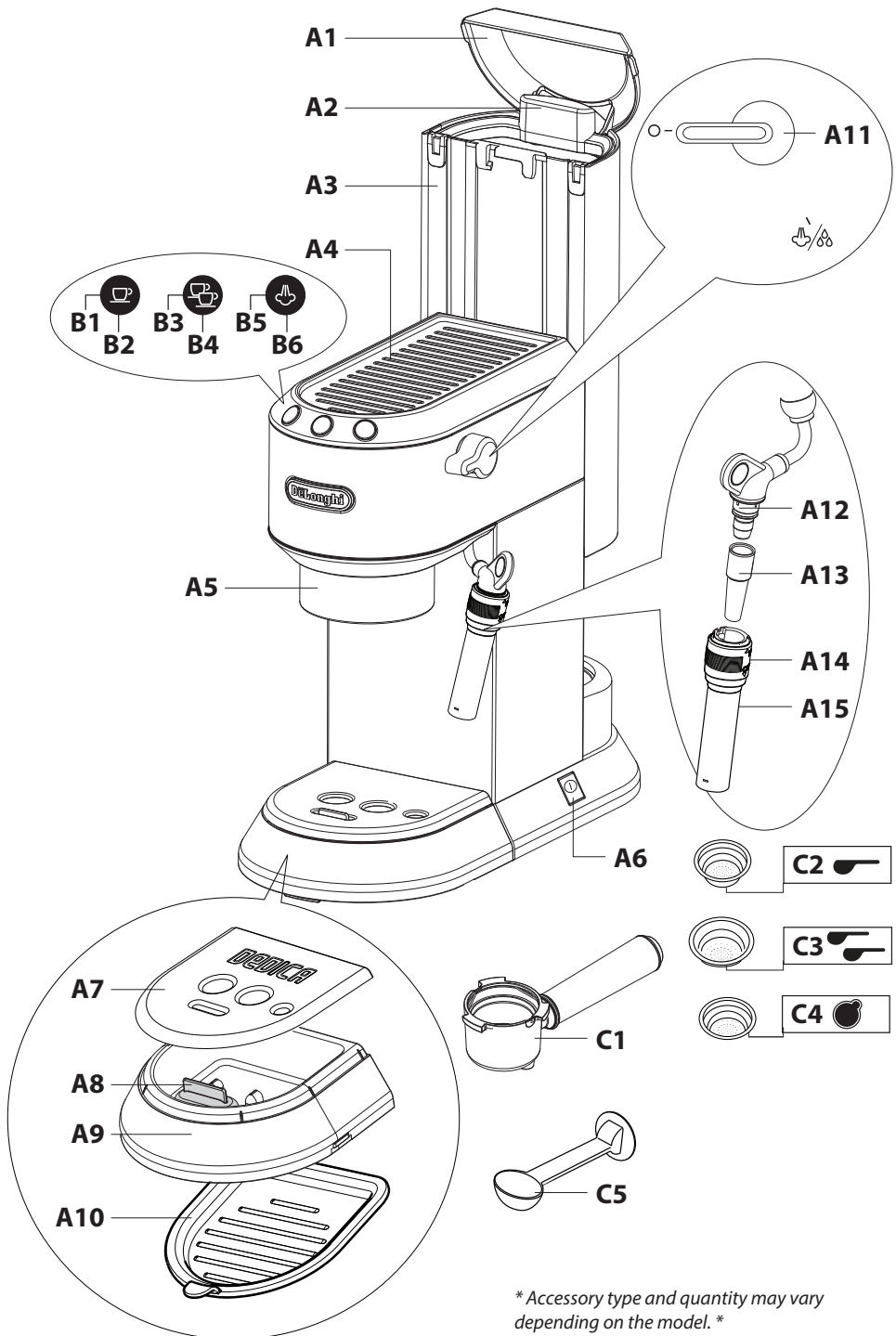

* Accessory type and quantity may vary depending on the model. *

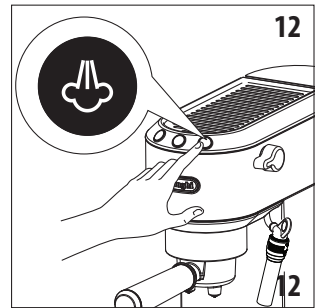
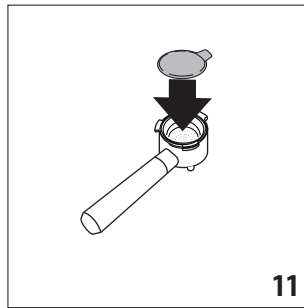
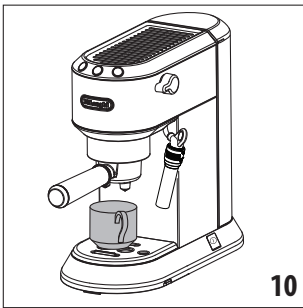
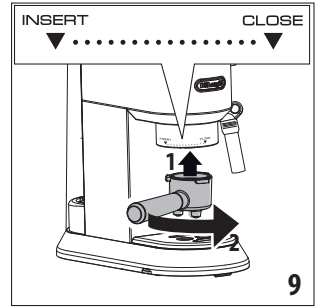
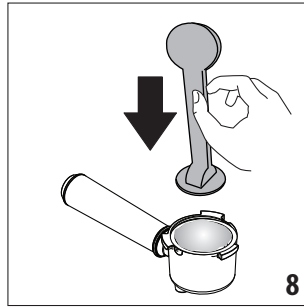
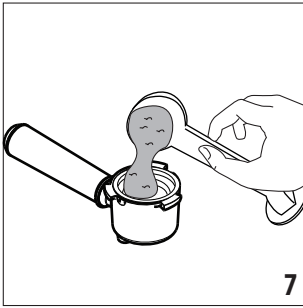
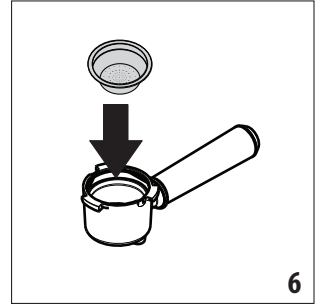
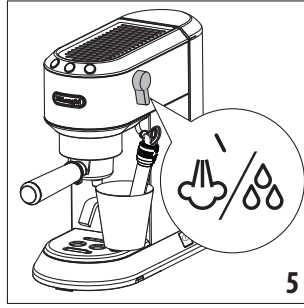
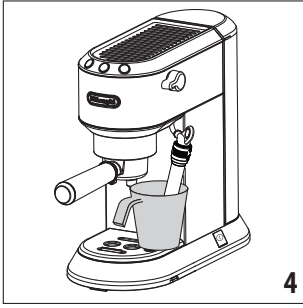
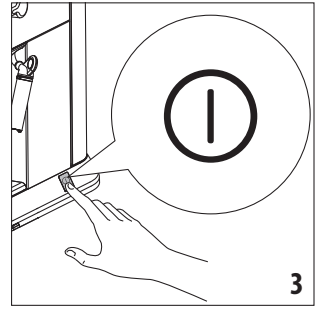
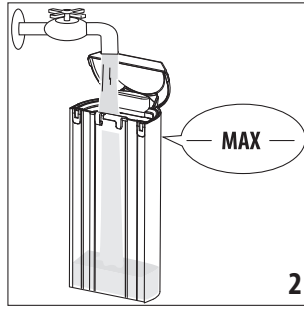
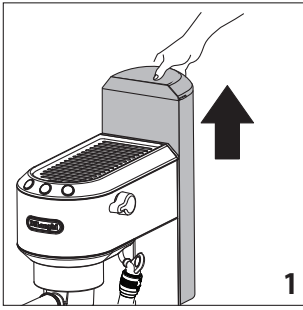

The images shown here are for illustrative purposes only and may be subject to change.

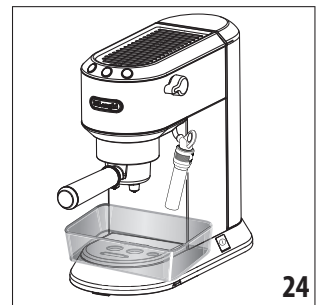
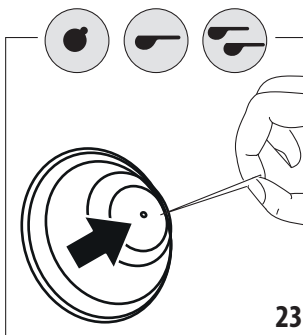
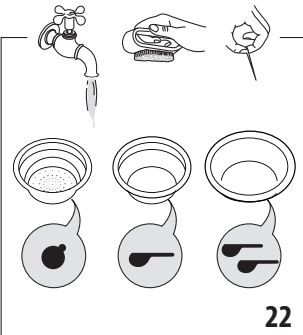
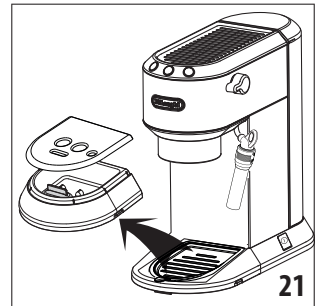
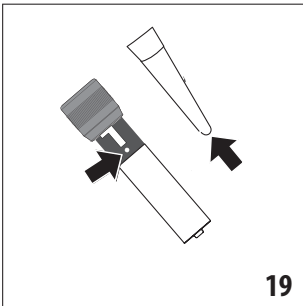
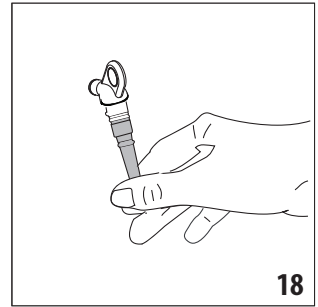
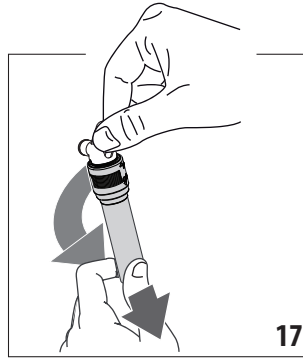
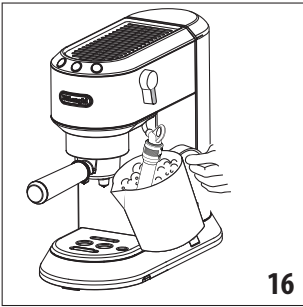
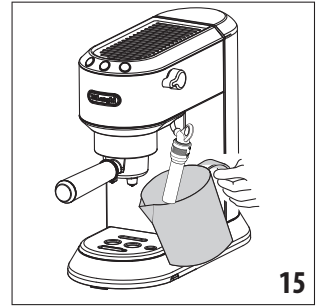
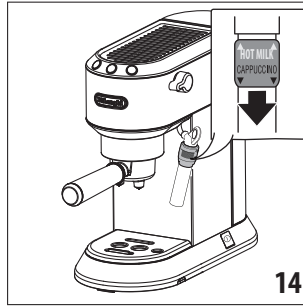
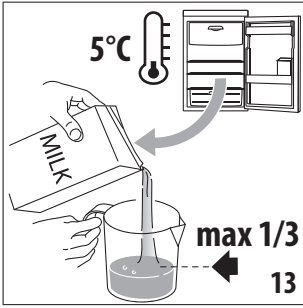

IMPORTANT SAFEGUARDS

When using electrical appliances, basic safety precautions should always be followed, including the following:

- Read all instructions.
- Do not touch hot surfaces. Use handles and knobs.
- To protect against fire, electrical shock and personal injury, do not immerse cord, plug or appliance in water or other liquid.
- Never allow the appliance to be used by children.
- Unplug from the outlet when not in use and before cleaning. Allow to cool before fitting or taking off parts, and before cleaning the appliance.
- Do not operate with a damaged cord or plug, or after the appliance malfunctions, or has been damaged in any manner.
- The use of accessory attachments or spare parts not recommended by the appliance manufacturer may result in fire, electrical shock or personal injury.
- Do not use outdoors.
- Do not let the cord hang over the edge of the table or counter, or touch hot surfaces.
- Do not place on or near a hot gas or electrical burner, or in a heated oven.
- Plug cord into the wall outlet. To disconnect, turn any control to "off", then remove plug from wall outlet.
- Do not use the appliance for other than the intended use. This appliance is to be utilized for domestic use only. Any other use is to be considered improper and therefore, dangerous.

WARNING: To reduce the risk of fire or electric shock, do not remove the exterior of the unit or the cover.

SAVE THESE INSTRUCTIONS

THIS PRODUCT IS FOR HOUSEHOLD USE ONLY

SHORT CORD INSTRUCTIONS

- A short power cord is provided to reduce risks resulting from becoming entangled in or tripping over a longer cord.
- Longer, detachable power supply cords or extension cords are available and may be used if care is exercised in their use.
- If an extension cord is used, the marked electrical rating should be at least as great as the electrical rating of the appliance. If the appliance is provided with 3- wire, grounding type cord, the extension should be a GROUNDING TYPE 3 - WIRE CORD. The longer cord should be arranged so that it will not drape over the counter-top or table top where it can be pulled on by children or tripped over.
- Your product is equipped with a polarized alternating current line plug (a plug having one blade wider than the other). This plug will fit into the power outlet only one way. This is a safety feature. If you are unable to insert the plug fully into the outlet, try reversing the plug. If the plug should still fail to fit, contact your electrician to replace your obsolete outlet. Do not defeat the safety purpose of the polarized plug.

1. SAFETY WARNINGS



Danger! Failure to observe the warning may result in life threatening injury by electric shock.

This is an electrical appliance and may cause electrical shocks.

You should therefore follow these safety warnings:

- Never touch the appliance with damp hands or feet.
- Never touch the plug with damp hands.
- Make sure the socket used is freely accessible at all times, enabling the appliance to be unplugged when necessary.
- Unplug directly from the plug only. Never pull the cord as you could damage it.
- To disconnect the appliance completely you must unplug it from the mains socket.
- If the appliance is faulty, do not attempt to repair. Turn it off, unplug from the mains socket and contact a service center.
- Before cleaning the appliance, turn it off, unplug from the mains socket and allow to cool.



Important: Failure to observe the warning could result in injury or damage to the appliance.

Keep all packaging (plastic bags, polystyrene foam) away from children.



Danger of burns! Failure to observe the warning could result in scalds or burns.

This appliance produces hot water and steam may form while it is in operation.

Avoid contact with splashes of water or hot steam.

1.1 Designated use and restrictions

This appliance is designed and made to prepare coffee or hot water and to heat milk using steam.

Use drinking water only to fill the tank as described in the Instruction for Use.

Never use the hot water/steam spout (A12) with beverages other than milk.

Any other use is considered improper and thus dangerous. The manufacturer is not liable for damage deriving from improper use of the appliance.

1.2 Instruction for Use

Read this Instruction for Use carefully before using the appliance. Failure to follow this Instruction for Use may result in burns or damage to the appliance.

The manufacturer is not liable for damage deriving from failure to respect this Instruction for Use.



Please note:

Keep this Instruction for Use. If the appliance is passed to other persons, they must also be provided with this Instruction for Use.

1.3 Checking the appliance

After removing the packaging, make sure the product is complete and undamaged and that all accessories are present. Do not use the appliance if it is visibly damaged. Contact a service center.

2. TECHNICAL DATA

Mains voltage: 120V~60Hz

Absorbed power: 1300 W

Pressure: 15 bar

Water tank capacity: 33.8 fl oz / 1 l

Size LxHxD.....5.86x12x13 (16.3) in / (149x305x330 (414) mm

Weight 8.9 lbs / 4.04 kg



None of the components or accessories is dish-washer safe.

3. DESCRIPTION

The terminology below will be used repeatedly on the following pages.

3.1 Description of the appliance

- A1. Water tank lid
- A2. Tank extraction handle
- A3. Water tank
- A4. Cup warmer
- A5. Boiler outlet
- A6. ON/OFF switch
- A7. Cup tray
- A8. Drip tray full indicator
- A9. Drip tray
- A10. Mugs or glasses tray
- A11. Steam dial
- A12. Hot water/steam spout
- A13. Hot water/steam connection nozzle
- A14. Cappuccino maker selection ring
- A15. Hot water/steam connection tube

3.2 Description control panel

- B1. One cup button
 - B2. ON light on button (white)
- B3. Two cups button
 - B4. ON light on button (white)
- B5. Steam button
 - B6. ON light on button (white)

3.3 Description of the accessories

- C1. Filter holder
- C2. 1 cup filter (☞ symbol under filter)
- C3. 2 cup filter (☞ symbol under filter)
- C4. Pod filter (● symbol under filter)
- C5. Measure/presser

4. INSTALLING THE APPLIANCE



Important!

When you install the appliance, you should respect the following safety warnings:

- Water penetrating the coffee maker could cause damage. Do not place the appliance near taps or sinks.
- The appliance could be damaged if the water it contains freezes. Do not install the appliance in a room where the temperature could drop below freezing point.

- Arrange the cord in such a way that it cannot be damaged by sharp edges or contact with hot surfaces (e.g. electric hot plates).
- The appliance gives off heat. After positioning the appliance on the worktop, leave a space of at least 3 cm between the surfaces of the appliance and the side and rear walls and at least 15 cm above the machine.
- Clean all the removable parts with tap water.

4.1 Connecting the appliance



Danger!

Check that the mains power supply voltage corresponds to that indicated on the rating plate on the bottom of the appliance. Connect the appliance to an efficiently earthed and correctly installed socket with a minimum current rating of 10A only. If the power socket does not match the plug on the appliance, have the socket replaced with a suitable type by a qualified professional.

5. FILLING THE WATER TANK



Please note:

Before first use, wash all the accessories and water tank with warm water.

1. Extract the tank by pulling it upwards (fig. 1).
2. Open the lid and fill the tank with fresh clean water, taking care not to exceed the MAX level (fig. 2). Put the tank back in the appliance, pressing lightly to open the valves located on the bottom of the tank.
3. More simply, the tank can also be filled without removing it, pouring the water directly from a jug.



Important:

Never operate the appliance without water in the tank or without the tank.





Please note:

It is normal for there to be water in the space under the tank. This should therefore be dried regularly with a clean sponge.

6. FIRST USE

At first use, rinse the internal circuit as follows:

1. Turn the appliance on by pressing the ON/OFF switch (fig. 3). The appliance performs a self-diagnosis cycle, indicated by sequential flashing of the three buttons.
2. The ☞ and ☞ lights flash to indicate the appliance is heating up. When the lights stop flashing and remain on steadily, the appliance is ready for operating the rinse.
3. Attach the filter holder to the appliance (fig. 9).

- Place a container with a minimum capacity of 500 ml under the boiler outlet (A5) (fig. 4) and press the  button. Repeat this operation 5 times.
- Empty the container and put it under the hot water/steam spout (A12) (fig. 4).
- Turn the hot water/steam dial to the  position (fig. 5) and deliver to empty the water tank (A3); then turn the knob to the  position.

7. PROGRAMMING THE SETTINGS MENU

To access the menu, make sure the appliance is ready for use, then press and hold the  button for 10 seconds until the three buttons flash in sequence:

The appliance is now in programming mode.

Set the coffee maker as you wish, then exit the settings menu by waiting for 15 seconds.

 **Please note:**

If no selections are made for 15 seconds, the appliance automatically exits programming and is ready for use again.

7.1 Setting coffee temperature

To modify the temperature of the water used to make the coffee, proceed as follows:

- Access the settings menu;
- Press the  button to enter the coffee temperature selection mode. The lights corresponding to the current selection come on:



- The lights start flashing in sequence;
- Press the button corresponding to the required temperature:



- The  button flashes to indicate that the selection has been saved.

The appliance exits the menu and is ready for use.

7.2 Setting water hardness



The appliance can also be programmed according to the hardness of the mains water in the various regions so that descaling needs to be performed more or less frequently.

Proceed as follows:

- Access the settings menu;
- Press the  button to enter the water hardness selection mode. The lights corresponding to the current selection come on:



- The lights start flashing in sequence;
- Press the button corresponding to the water hardness in your area:

 soft water	 medium water	 hard water
<10°dH	10°dH - 20°dH	>20°dH
<18°FH	18°FH - 36°FH	>36°FH
<180mg/l CaCO ₃	180-360mg/l CaCO ₃	>360mg/l CaCO ₃

- The  button flashes to indicate that the selection has been saved.

The appliance exits the menu and is ready for use.

7.3 Adjusting auto-off (stand-by)

To save energy, an auto-off function turns the appliance off when not used for a long period. To turn it back on again, press any button on the control panel.

- Access the settings menu;
- Press the  button to enter the auto-off time selection mode. The lights corresponding to the current selection come on:



- The lights start flashing in sequence;
- Press the button corresponding to the required time:







5. The  button flashes to indicate that the selection has been saved.

The appliance exits the menu and is ready for use.

7.4 Default values (reset)

This resets all menu settings and programmed quantities back to the default values.

To reset the default values, proceed as follows:

1. Position the steam spout over the drip tray;
2. Access the settings menu;
3. Turn the steam dial to the  position;
4. Press the  button. The three lights flash simultaneously to confirm that the original settings have been restored.
5. The  and  lights flash to indicate that the steam dial must be closed again (○ symbol).

When the steam dial has been closed, the appliance is ready for use.



8. HOW TO MAKE ESPRESSO COFFEE

8.1 Tips for a hotter coffee

For hotter espresso coffee, you should:

- You are recommended to warm the cups before making coffee by rinsing them with a little hot water.
- Attach the filter holder to the appliance with the filter in place but **without adding coffee**. Using the same cup as will later be used to make the coffee, press the 1 cup button and deliver hot water into the cup to heat it.
- Raise the coffee temperature in the settings menu.
- Rest the cups you will be using on the cup warmer (A4) which becomes hot during operation.



8.2 How to prepare espresso coffee using pre-ground coffee

1. Place the ground coffee filter (C2 or C3) in the filter holder (fig. 6). To make one coffee, use the filter with the  symbol on the bottom, to make two coffees, use the filter with the  symbol on the bottom.
2. To make just one coffee, place one level measure of pre-ground coffee (about 7 g) in the filter (fig. 7). To make two coffees, place two loosely filled measures (about 7+7 g) of pre-ground coffee in the filter. Fill the filter a little at a time to prevent the pre-ground coffee from overflowing.



Important:

For correct operation, before filling with pre-ground coffee, make sure there are no coffee residues left in the filter from the last time you made coffee.

3. Distribute the pre-ground coffee evenly and press lightly with the presser (fig. 8).
Correct pressing of the pre-ground coffee is essential to obtain a good espresso. If you press too firmly, the coffee will be delivered slowly and will be strong. If you press too lightly, the coffee will be delivered quickly and will be weak.
4. Remove any excess coffee from the rim of the filter holder and attach the filter holder to the appliance. To attach correctly, align the filter holder handle with the INSERT symbol (fig. 9), attach the filter holder and rotate the handle towards the right until aligned with the CLOSE symbol.
5. Place the cup or cups under the filter holder spouts (fig. 10).
6. Make sure the lights corresponding to the coffee buttons are on, then press the  or  coffee button. The appliance proceeds to make the coffee and delivery is interrupted automatically.
7. To remove the filter holder, turn the handle from right to left.



Danger of burns!

To avoid splashes, never remove the filter holder while the appliance is delivering coffee. Always wait for a few seconds after delivery.

8.3 How to make espresso coffee using pods



Please note:

Use pods conforming to the ESE standard, indicated on the pack by the following symbol.



The ESE standard is a system accepted by leading pod producers and enables espresso coffee to be prepared simply and cleanly.

1. Place the filter for coffee pods (with the  symbol on the bottom) in the filter holder.
2. Insert the pod, centring it as far as possible on the filter (fig. 11). Always follow the instructions on the pod pack to position the pod on the filter correctly.
Proceed as described in points 4 to 6 in the previous section.



Please note:

- While the appliance is making coffee, delivery can be interrupted at any moment by pressing the coffee button pressed previously.
- At the end of delivery (within 3 seconds), to increase the amount of coffee in the cup, press and hold the coffee but-

ton pressed previously. Delivery is automatically interrupted after a few seconds.

- To remove the filter holder, turn the handle from right to left.





Danger of burns!



To avoid splashes, never remove the filter holder while the appliance is delivering coffee. Always wait for a few seconds after delivery.

8.4 Programming the quantities of coffee in the cup

The appliance is set by default to automatically deliver standard quantities. To change these quantities, proceed as follows:

1. Place one or two cups under the filter holder spouts.
2. Press and hold the button you want to programme ( or ). The coffee maker starts delivering coffee and the other coffee button flashes to indicate that the appliance is in programming mode.
3. Once the required quantity of coffee has been delivered into the cup, release the button. Delivery stops and the light flashes to indicate that the quantity has been saved correctly.
4. When the two coffee lights come on steadily, the appliance is ready for use.



9. HOW TO MAKE CAPPUCCINO

1. Prepare the espresso coffees as described in the previous sections, using sufficiently large cups. To use tall glasses, remove the drip tray and stand the glasses on the glasses tray (A10);
2. Press the  button (fig. 12). The light flashes;
3. In the meantime, fill a recipient with about 100 grams of milk for each cappuccino to be prepared. For a denser more even froth, you must use skimmed or partially skimmed milk at refrigerator temperature (about 5°C). In choosing the size of the recipient, bear in mind that the milk doubles or triples in volume (fig. 13).
4. Make sure the cappuccino maker selection ring (A14) is in the "CAPPUCCINO" position (fig. 14);
5. Wait for the light corresponding to the  button to come on steadily, indicating that the boiler has reached the ideal temperature to produce steam.
6. Position an empty container under the cappuccino maker and open the dial for a few seconds to eliminate any air left in the circuit. Close the dial again.
7. Place the recipient containing the milk under the cappuccino maker.

8. Immerse the cappuccino maker in the milk container. Never immerse the black ring (fig. 15). Turn the dial to the  position. Steam is delivered from the cappuccino maker, giving the milk a creamy frothy appearance (fig. 16). To obtain a creamier froth, immerse the cappuccino maker in the milk and rotate the container with slow upward movements.
9. When the required temperature (the ideal is 60°C) and froth density is reached, interrupt steam delivery by turning the steam dial clockwise.
10. Pour the frothed milk into the cups containing the espresso coffee prepared previously. The cappuccino is ready. Sweeten to taste and if desired, sprinkle the froth with a little cocoa powder.



Please note:

- to prepare more than one cappuccino, first make all the coffees then at the end prepare the frothed milk for all the cappuccinos;
- to exit the steam function, press any button. The  and  lights flash to indicate that the temperature is too high to make coffee (see section "Cooling the boiler").

You should not deliver steam for more than 60 seconds.

10. MAKING HOT MILK

To make hot milk without froth, proceed as described in the above section, making sure the cappuccino maker selection ring (A14) is positioned upwards in the "HOT MILK" position.

11. CLEANING THE CAPPUCCINO MAKER AFTER USE



Important:

For hygiene reasons, the cappuccino maker should always be cleaned after use.

Proceed as follows:

1. Turn the steam dial to deliver a little steam for a few seconds (points 2, 5 and 6 of the previous section). This causes the cappuccino maker to discharge any milk left inside. Press the ON/OFF button to turn the appliance off.
2. Wait a few minutes for the cappuccino maker to cool down. With one hand, hold the cappuccino maker tube firmly, with the other, release the cappuccino maker by turning it clockwise, then pull off downwards (fig. 17).
3. Remove the rubber steam connection nozzle from the spout by pulling it downwards (fig. 18).
4. Push the ring upwards and make sure the two holes shown by the arrows in fig. 19 are not blocked. If necessary, clean with a pin;

5. Replace the nozzle, move the ring downwards and put the cappuccino maker back on the connection nozzle, turning it and pushing it upwards until it is attached.

12. COOLING THE BOILER

To make coffee again immediately after frothing milk, the boiler must first be cooled or the coffee will be burnt. Proceed as follows:

- place a container under the cappuccino maker;
- open the steam dial to deliver hot water and cool the boiler;
- hot water delivery is interrupted automatically when the boiler is cool. When the pump stops operating and no more water is delivered, close the steam dial.

The coffee maker is now ready for use.

13. HOT WATER

1. Press the ON/OFF button (fig. 3) to turn the appliance on. Wait for the coffee lights to come on steadily.
2. Place a recipient under the cappuccino maker.
3. Turn the dial to the  position. Hot water is delivered from the cappuccino maker.
4. To stop hot water delivery, close the dial and press any button.

You should not deliver hot water for more than 60 seconds.

14. CLEANING

14.1 Cleaning the machine

The following parts of the machine must be cleaned regularly:

- drip tray (A9)
- the coffee filters (C2, C3 and C4);
- the boiler outlet (A5);
- water tank (A3);
- the cappuccino maker (A15) as described in section "11. Cleaning the cappuccino maker after use";

Important!

- Do not use solvents, abrasive detergents or alcohol to clean the coffee machine.
- Do not use metal objects to remove encrustations or coffee deposits as they could scratch metal or plastic surfaces.
- If the appliance is not used for more than one week, before using it again, we strongly recommend you perform a rinse cycle as described in section "6. first use".

Danger!

- While cleaning, never immerse the coffee maker in water. It is an electrical appliance.

- Before cleaning the outside of the appliance, turn it off, unplug from the mains socket and allow to cool.

14.2 Cleaning the drip tray

Important!

The drip tray is fitted with a level indicator (red) showing the level of water it contains (fig. 20). Before the indicator protrudes from the cup tray, the drip tray must be emptied and cleaned otherwise the water may overflow the edge and damage the appliance, the surface it rests on or the surrounding area.

1. Remove the drip tray (fig. 21).
2. Remove the cup tray (A7), empty the water and clean the drip tray with a cloth, then reassemble the drip tray. Extract the mugs or glasses tray (A10), clean with water, dry and put back in the machine;
3. Put the drip tray back in place.

14.3 Cleaning the coffee filters

Clean the coffee filters regularly:

1. Rinse the filters under running water (fig. 22);
2. Make sure the holes are not blocked. If necessary, clean with a pin (figs. 22 and 23).

14.4 Cleaning the boiler outlet

After every 200 coffees, rinse the boiler outlet by delivering about 0.5 l of water from the boiler outlet (press the coffee button without using ground coffee).

14.5 Other cleaning operations

1. Do not use solvents or abrasive detergents to clean the coffee maker. Use a soft damp cloth only.
2. Clean the filter holder cup.

14.6 Cleaning the water tank





1. Clean the water tank regularly (about once a month) with a damp cloth and a little mild washing up liquid.
2. Fill the tank with fresh water and replace the tank;

Danger!





While cleaning, never immerse the coffee maker in water. It is an electrical appliance.

15. EXPLANATION OF LIGHTS

Lights	Operation	Explanation of lights
	The ON/OFF button is turned on	The appliance performs a self-diagnosis cycle, indicated by sequential flashing of the lights
	When the appliance is turned on	Flashing lights: the appliance is heating up to make coffee Lights on steadily: the appliance is ready to make coffee The lights flash rapidly: the tank is empty or the appliance will not make coffee. See the section "5. Filling the water tank"
	The steam function is required	Flashing light: the appliance is heating up to deliver steam Light on steadily: the appliance is ready to deliver steam
	Steam dial open	Flashing lights: close the steam dial
	High boiler temperature	Flashing lights: Cool as described in section "12. Cooling the boiler"

16. TROUBLESHOOTING

Problem	Cause	Solution
No espresso coffee is delivered	No water in the tank	Fill the tank
	The holes in the filter holder are blocked	Clean the filter holder spout holes
	The filter is blocked	Clean as described in section "14.3 Cleaning the coffee filters"
	The tank has been inserted incorrectly and the valves on the bottom are not open	Press the tank down lightly to open the valves on the bottom

The espresso coffee drips from the edges of the filter holder rather than the holes	The filter holder has been inserted incorrectly or is dirty	Attach the filter holder correctly and rotate firmly as far as it will go
	The espresso boiler gasket has lost elasticity or is dirty	Have the espresso boiler gasket replaced by contact a service center.
	The holes in the filter holder spouts are blocked	Clean the filter holder spout holes
	The filter is blocked	Clean as described in section "14.3 Cleaning the coffee filters"
The filter holder cannot be attached to the appliance	Too much coffee has been placed in the filter	Use the measure supplied and make sure you are using the correct filter for the type of preparation
The coffee froth is too light (delivered from the spout too fast)	The pre-ground coffee is not pressed down firmly enough	Press the pre-ground coffee more firmly
	There is not enough pre-ground coffee	Increase the quantity of pre-ground coffee
	The pre-ground coffee is too coarse	Use only pre-ground coffee for espresso coffee makers
	The wrong type of pre-ground coffee is being used	Change the type of pre-ground coffee
The coffee froth is too dark (delivered from the spout too slowly)	The pre-ground coffee is pressed down too firmly	Press the coffee down less firmly
	There is not enough pre-ground coffee	Reduce the quantity of pre-ground coffee
	The espresso boiler outlet is blocked	Clean as described in section "14.4 Cleaning the boiler outlet"
	The filter is blocked	Clean as described in section "14.3 Cleaning the coffee filters"
	The pre-ground coffee is too fine	Use only pre-ground coffee for espresso coffee makers
	The pre-ground coffee is too fine or damp	Use pre-ground coffee for espresso coffee makers only and make sure it is not too damp
After delivering coffee, the filter remains attached to the boiler outlet		Insert the filter holder again, deliver coffee, then remove the filter holder
The appliance will not make any drink and the  ,  and  lights flash for a few seconds	No water in the tank	Fill the tank with water
	The tank has been inserted incorrectly and the valves on the bottom are not open	Press the tank down lightly to open the valves on the bottom
	The espresso boiler outlet is blocked	Clean as described in section "14.4 Cleaning the boiler outlet"
	The filter is blocked	Clean as described in section "14.3 Cleaning the coffee filters"

The appliance does not function and all the lights flash		Disconnect the appliance immediately and contact a service center.
No milk froth is formed when making cappuccino	The ring is in the "HOT MILK" position	Push the ring into the "CAPPUCCINO" position.
	Milk not cold enough	Always use milk at refrigerator temperature
	Cappuccino maker dirty	Clean as described in section "11. Cleaning the cappuccino maker after use"



8 1 4 1 0 0 1 2 6

