

Please read this manual carefully before operating your unit and retain for future reference.

804106911

## Safety Information

### Notice for customers in the United States of America

#### Supplier's Declaration of Conformity

Trade Name: SONY  
Model: KD-85X85K / KD-85X80K / KD-85X80CK / KD-75X85K / KD-65X85K / KD-55X85K / KD-50X85K / KD-43X85K

#### FCC Related Information

This equipment has been tested and found to comply with the limits for a Class B digital device, pursuant to Part 15 of the FCC Rules. These limits are designed to provide reasonable protection against harmful interference in a residential installation. This equipment generates, uses and can radiate radio frequency energy and, if not installed and used in accordance with the instructions, may cause harmful interference to radio communications. However, there is no guarantee that interference will not occur in a particular installation. If this equipment does cause harmful interference to radio or television reception, which can be determined by turning the equipment off and on, the user is encouraged to try to correct the interference by one or more of the following measures:

- Reorient or relocate the receiving antenna.
- Increase the separation between the equipment and receiver.
- Connect the equipment into an outlet on a circuit different from that to which the receiver is connected.
- Consult the dealer or an experienced radio/TV technician for help.

Pursuant to FCC regulations, you are cautioned that any changes or modifications not expressly approved in this manual could void your authority to operate this equipment.

#### Safety and Regulatory

FCC regulations restrict operation of this device to indoor use only.

#### Notice for customers in Canada

This device contains licence-exempt transmitter(s)/ receiver(s) that comply with Innovation, Science and Economic Development Canada's licence-exempt RSS(s). Operation is subject to the following two conditions:  
(1) This device may not cause interference.  
(2) This device must accept any interference, including interference that may cause undesired operation of the device.

To prevent radio interference to the licensed service, this device is intended to be operated indoors and away from windows to provide maximum shielding. Equipment (or its transmit antenna) that is installed outdoors is subject to licensing.

High-power radars are allocated as primary users (i.e. priority users) of the bands 5250-5350 MHz and 5650-5850 MHz and that these radars could cause interference and/or damage to LE-LAN devices.

#### Notice for customers in the United States of America and Canada

This equipment complies with FCC/IC radiation exposure limits set forth for an uncontrolled environment and meets the FCC radio frequency (RF) Exposure Guidelines and RSS-102 of the IC radio frequency (RF) Exposure rules. This equipment should be installed and operated keeping the radiator at least 20 cm or more away from person's body (excluding extremities: hands, wrists, feet and ankles).

This device and its antenna(s) must not be co-located or operating with any other antenna or transmitter except Grant condition.

#### Compatible Wall-Mount Bracket Information

(Wall-Mount Bracket not supplied)

Use the following Sony Wall-Mount Bracket with your TV model.

Sony TV Model No.	KD-75X85K / 65X85K / 55X85K
Sony Wall-Mount Bracket Model No.	SU-WL855*1

Use with other Wall-Mount Brackets\*2 may cause instability and could result in property damage or injury.

- \*1 Only for limited region/country/model.
- \*2 For instructions on using the Wall-Mount Bracket with your TV please go to <https://www.sony.com/am/support> for your TV model and download "Wall-Mount Bracket".

#### Before setting up your TV

Some TV models are packaged with a detached Table-Top Stand so you can mount your TV to a wall right away. See "Installing the TV to the Wall" if you want to mount the TV to a wall. If you are not mounting the TV to a wall, you will need to attach the Table-Top Stand (refer to the Setup Guide).

Be sure to consider the following while setting up your TV:

- Disconnect all cables when carrying the TV.
- Two or more persons (three or more persons for 214.8 cm (85 inches) and above TV) are needed to transport a large TV set.
- Correct hand placement while carrying the TV is very important for safety and to avoid damage.

**KD-85X85K / 85X80K / 85X80CK**

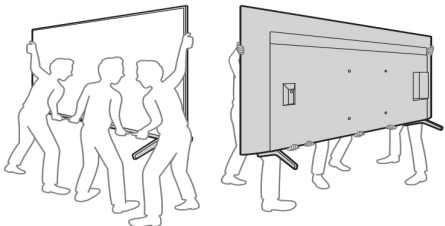

**KD-75X85K / 65X85K / 55X85K / 50X85K / 43X85K**

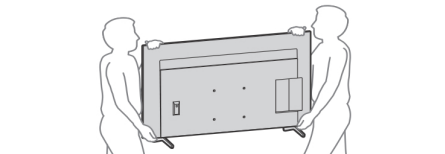

- Ensure your TV has adequate ventilation, refer to the safety documentation.
- For best picture quality, do not expose the screen to direct illumination or sunlight.
- Avoid installing the TV in a room with reflective wall and floor materials.
- Avoid moving the TV from a cold area to a warm area. Sudden room temperature changes may cause moisture condensation. This may cause the TV to show poor picture and/or poor color. Should this occur, allow moisture to evaporate completely before powering the TV on.

#### Securing the TV



Sony strongly recommends taking measures to prevent the TV from toppling over. Unsecured TVs may topple and result in property damage, serious bodily injury or even death.

#### Preventing the TV from Toppling

- Secure the TV to a wall and/or Stand.
- Do not allow children to play or climb on furniture and TV sets.
- Avoid placing or hanging items on the TV.
- Never install the TV on:
  - Slippery, unstable and/or uneven surfaces.
  - Furniture that can easily be used as steps, such as a chest of drawers.
- Install the TV where it cannot be pulled, pushed, or knocked over.
- Install the TV so that the TV's Table-Top Stand does not protrude out from the Stand (not supplied). If the Table-Top Stand protrudes out from the Stand, it may cause TV set to topple over, fall down, and cause personal injury or damage to the TV.



- Route all AC power cords and connecting cables so that they are not accessible to curious children.

#### Recommended Measures to Secure the TV

Consider the following measures when securing your TV to a Stand (not supplied).

##### 1 Secure the Stand for the TV.

Make sure the Stand can adequately support the weight of the TV. Use two angle braces (not supplied) to secure the Stand. For each angle brace use the appropriate hardware to:

- Attach one side of the angle brace to the wall stud.
- Attach the other side to the Stand.

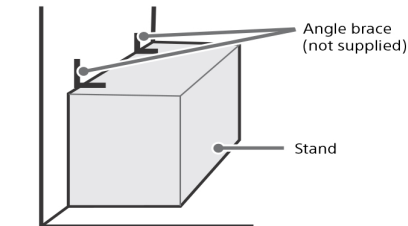

##### 2 Secure the TV to the Stand.

Use the optional hardware listed as follows (not supplied):

- M6 machine screws (screwed into the TV's rear cover).
- A screw or similar (attach it to the Stand).
- Rope or chain (strong enough to support the weight of the TV). Make sure that there is no excess slack in the rope or chain.

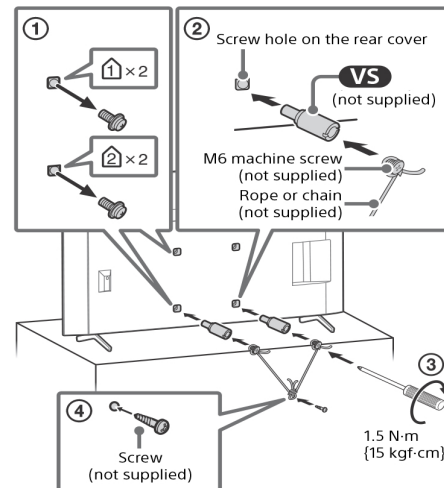

The length of the M6 machine screw differs depending on the rope or chain diameter. Please refer to below illustration.

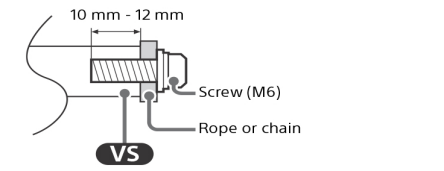

##### 3 Anchor the TV to the wall by using bolts, wall anchor and chain (or rope).

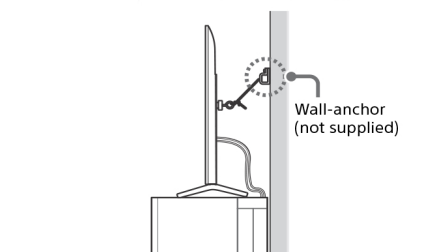
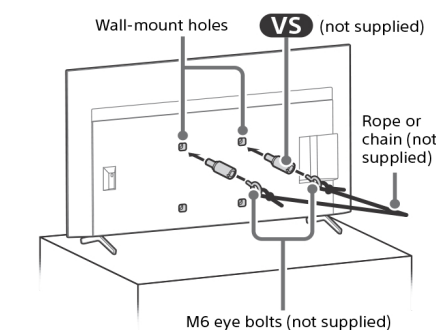

Please refer to below illustration for M6 eye bolt length.

The images shown here are for illustrative purposes only and may be subject to change.

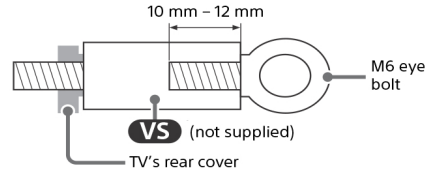

#### Note

- Your TV is shipped with screws attached to the rear of the TV depending on the TV model. (They are fastened in the screw holes for wall mounting.) Be sure to remove the upper two screws prior to anchoring the TV to a wall.
- Securing the TV to the Stand without securing the TV and the Stand to the wall provides minimum protection against the TV toppling over. For further protection, be sure to follow the three measures recommended.

## Remote Control and TV

The remote control shape, layout, availability and function of remote control buttons may vary depending on your region/country/TV model/TV settings\*1.

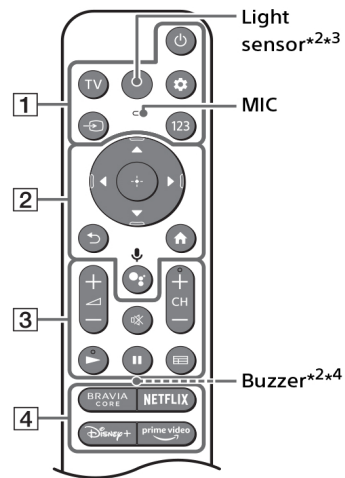

##### 1 ⏻ (Power)

**TV:** Display TV channel list or switch to input.

**⚙️ (Quick settings):** Display Quick Settings.

**➡️ (Input):** Display and select the input source, etc.

**123 (Control menu):** Display the Control menu.

##### 2 ▲ / ▼ / ◀ / ▶ / ⏪ / ⏩

On screen menu navigation and selection.

##### ⏮ (Back)

##### 🏠 (Home)

**🗣️ (Google Assistant) / 🎤 (Microphone):** Use Google Assistant\*5\*6.

##### 3 🔊 + / - (Volume)

**🔇 (Mute)\*7**

##### CH + / - (Channel)

##### 📺 / ⏸

**(Guide):** Display the digital program guide of TV or Cable/Satellite box\*8.

##### 4 App buttons

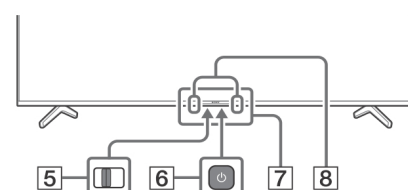

##### 5 BUILT-IN MIC SWITCH\*5: Turn on/off the built-in MIC.

##### 6 ⏻ (Power)

##### 7 Remote Control sensor / Light sensor / LED

##### 8 Built-in MIC\*5\*6\*9: To enable the built-in MIC, press the Google Assistant button on the remote control and follow the on-screen instructions.

- \*1 For other remote control models, refer to the online Help Guide for details.
- \*2 RMF-TX900U only. To see the model name of the remote control, open the remote control cover and see the label on the remote control.
- \*3 The remote control backlight will illuminate when the light sensor detects the ambient light is low. Automatic illumination of the backlight can be turned off.
- \*4 The buzzer will emit a sound when you use the remote finder function. Refer to the online Help Guide for details.
- \*5 Only for limited region/country/model/language.
- \*6 Google Assistant requires an Internet connection.
- \*7 Accessibility shortcut is available by pressing and holding 🔇 (Mute).
- \*8 [Cable/Satellite box setup] setting is required.
- \*9 Power consumption will increase when the built-in MIC is enabled as it is always listening.

The remote control vary depend of model: The buttons on the remote control may have a different name or location than the remote control shows in this manual.



For more information, refer to the Help Guide. Press ➡️ (Input) on the remote control and select [Help]. If [Help] does not exist, select [Edit] and add [Help].

#### Guidelines for IR Remote Control

- Point your remote control directly at the IR sensor located on your TV.
- Make sure that no objects are blocking the path between the remote control and the IR sensor on your TV.

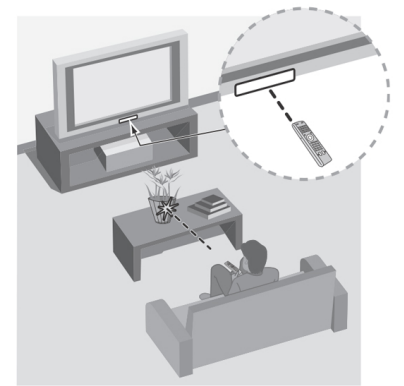

- Fluorescent lamps can interfere with your remote control; try turning off the fluorescent lamps.
- If you are having problems with the remote control, reinsert or replace your batteries and make sure that they are correctly inserted.

## Installing the TV to the Wall

### Using the optional Wall-Mount Bracket (SU-WL855 only)\* (not supplied)

#### To Customers:

For product protection and safety reasons, Sony strongly recommends that installation of your TV be performed by Sony dealers or licensed contractors. Do not attempt to install it yourself.

#### To Sony Dealers and Contractors:

Provide full attention to safety during the installation, periodic maintenance and examination of this product.

#### Wall-Mount Bracket Installation Information

For instructions on Wall-Mount Bracket installation, see the Installation Information (Wall-Mount Bracket) on the Sony Customer Support website for your TV model at the following address.

<https://www.sony.com/am/support>

- Follow the instruction guide provided with the Wall-Mount Bracket for your model. Sufficient expertise is required in installing this TV, especially to determine the strength of the wall for withstanding the TV's weight.
- Sony is not liable for any damage or injury caused by mishandling or improper installation.
- The length of the screw for Wall-Mount Bracket differs depending on the Wall-Mount Bracket thickness. Please refer to below illustration.

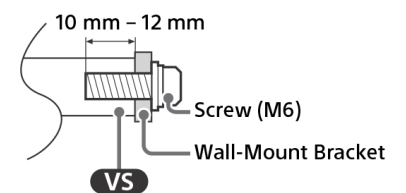

- Be sure to store the unused screws and Table-Top Stand in a safe place until you are ready to attach the Table-Top Stand. Keep the screws away from small children.

#### Note

- Read the supplied safety documentation for additional safety information.

\* Only for limited region/country/model.

### Using the optional Wall-Mount Bracket (Except SU-WL855) (not supplied)

This TV's instruction manual only provides the steps to prepare the TV for Wall-Mount installation before it is installed on the wall.

Your TV can be mounted to a wall using a suitable Wall-Mount Bracket (not supplied). If the Table-Top Stand is attached to the TV, the TV may require detaching the Table-Top Stand; see "Detaching the Table-Top Stand from the TV".

Prepare the TV for the Wall-Mount Bracket before making cable connections.

**For product protection and safety reasons, Sony strongly recommends that installation of your TV on the wall be performed by qualified professionals. Do not attempt to install it yourself.**

- Follow the instruction guide provided with the Wall-Mount Bracket for your model. Sufficient expertise is required in installing this TV, especially to determine the strength of the wall for withstanding the TV's weight.



# SONY

Television

## Setup Guide

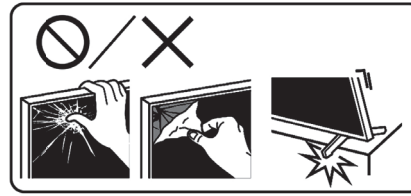

### BRAVIA

KD-85X85K / 85X80K / 85X80CK  
KD-75X85K / 65X85K

804006911

1

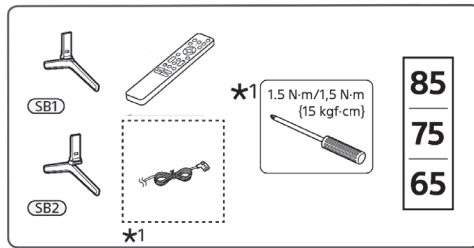

2

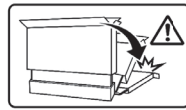

3



Accessory type and quantity may vary depending on the model

4

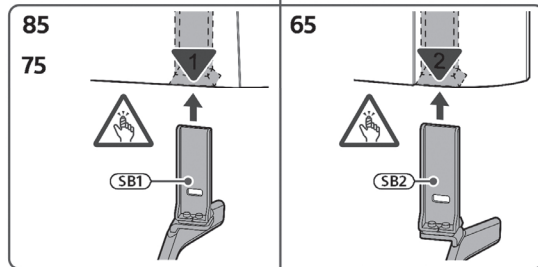
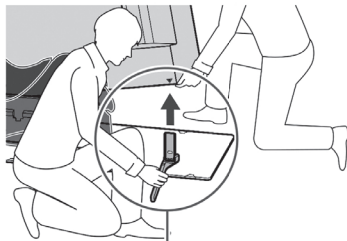

5

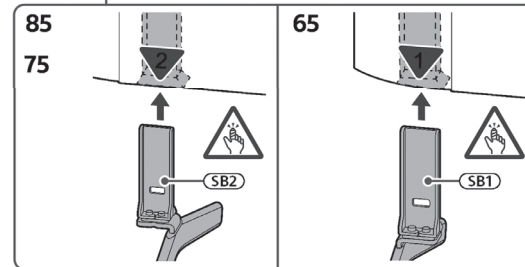
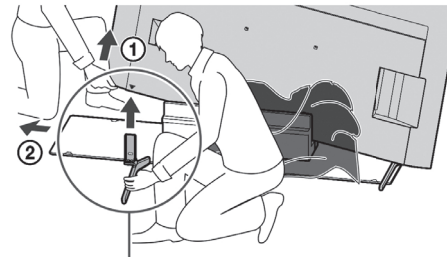

6

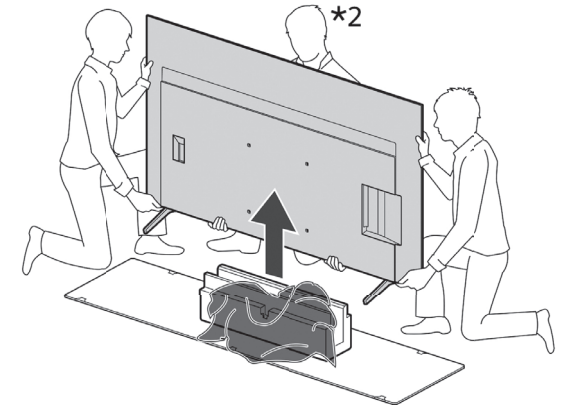

\*1 Refer Reference Guide

\*2 Only for limited region/country/model.

The images shown here are for illustrative purpose only and may be subject to change.

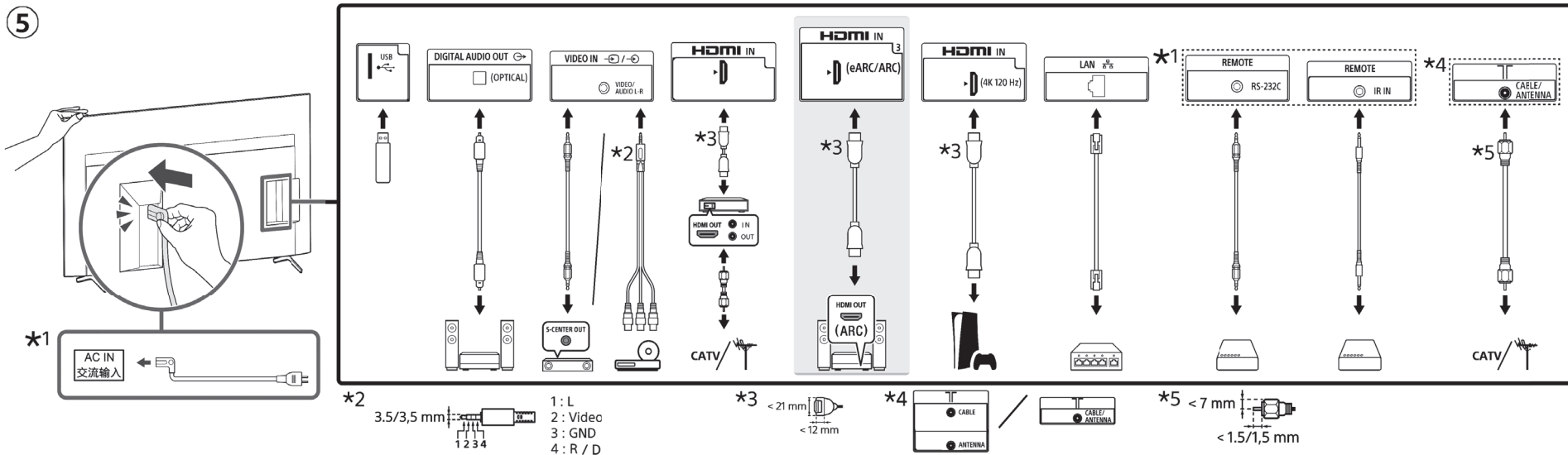

The cables mentioned in this guide is not supplied with your unit.

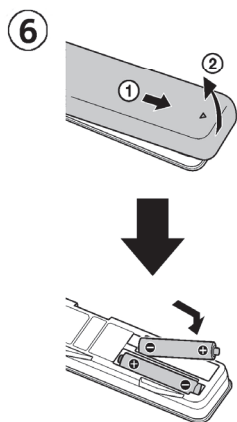

(Batteries not included)

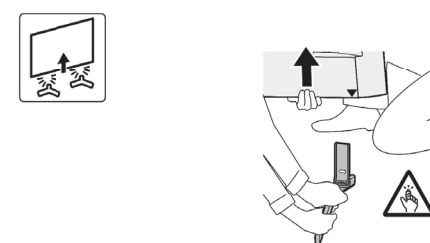
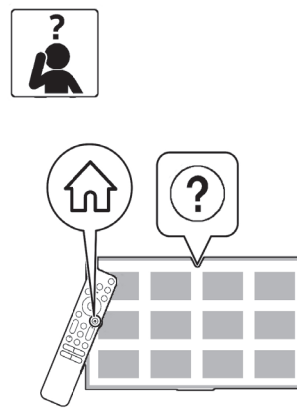
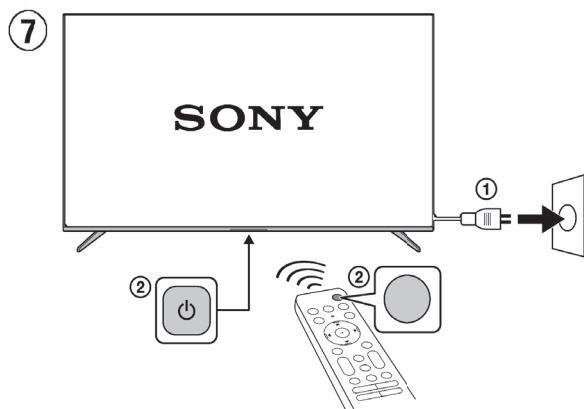

The remote control vary depend of model: The buttons on the remote control may have a different name or location than the remote control shows in this manual.

The image shown here is for illustrative purposes only and may be subject to change.

Illustrations may differ from actual product. We are constantly striving to improve our products; therefore the specifications contained herein are subject to change without notice.

