

Midea

USER MANUAL

804106832

Warning: Before using this product, please read this manual carefully and keep it for future reference. The design and specifications are subject to change without prior notice for product improvement. Consult with your dealer or the manufacturer for details.

Read This Manual

Inside you'll find many helpful hints on how to use and maintain your air conditioner properly. Just a little preventive care on your part can save you a great deal of time and money over the life of your air conditioner. You'll find many answers to common problems in the troubleshooting tips - you should be able to fix most of them quickly before calling service. These instructions may not cover every possible condition of use, so common sense and attention to safety is required when installing, operating and maintaining this product.

CAUTION

- For support, please contact a service center
- This appliance is not intended for use by people (including children) with reduced physical, sensory or mental capabilities or lack of experience and knowledge, unless they have been given supervision or instruction concerning use of the appliance by a person responsible for their safety.
- Children should be supervised to ensure that they do not play with the air conditioner.
- The appliance shall be installed in accordance with national wiring regulations.
- Do not operate your air conditioner in a humid room such as a bathroom or laundry room.

SAFETY PRECAUTIONS

To prevent injury to the user or other people and property damage, the instructions shown here must be followed. Incorrect operation due to ignoring of instructions may cause harm or damage. The level of risk is shown by the following indications.

WARNING

This symbol indicates a hazardous situation which, if not avoided, could result in death or serious injury.

CAUTION

This symbol indicates a hazardous situation, which, if not avoided, could result in minor or moderate injury.

NOTICE

This symbol addresses practices not related to physical injury.

WARNING

- Be sure the air conditioner has been securely and correctly installed according to the installation instructions in this manual. Save this manual for possible future use in removing or installing this unit.
- Plug in power cord plug properly. Otherwise, it may cause electric shock or fire due to excess heat generation.
- Do not modify power cord length or share the outlet with other appliances as it may cause electric shock or fire due to overheating.
- Always ensure effective grounding. Incorrect grounding may cause electric shock.
- Unplug the unit if you notice unusual sounds or smells or smoke coming from it. A damaged product may cause fire and electric shock.
- Ventilate room before operating the air conditioner if there is a gas leakage from another appliance.
- Do not operate or stop the unit by inserting or pulling out the power cord plug.
- Do not operate with wet hands or in very humid environments. It may cause electric shock.
- Do not allow water to come into contact with any electric parts. It may cause failure or electric shock.
- Do not use the socket if it is loose or damaged. It may cause fire and electric shock.
- Do not use or keep the power cord close to heating appliances. It may cause fire and electric shock.
- Do not use any devices or materials for installation that are not recommended in this manual.

WARNING

- Do not disassemble or modify unit. It may cause failure and electric shock.
- Do not damage or use an alternate power cord. It may cause fire and electric shock.
- If the power cord is damaged, it must be replaced by the manufacturer or an authorized service center or a similarly qualified person in order to avoid a hazard.
- Do not direct airflow straight into persons to avoid possible health hazard.
- Do not open the unit during operation. It may cause electric shock.
- Do not use the power cord near flammable gas or combustibles, such as gasoline, benzene, thinner, etc. It may cause an explosion or fire.
- Do not let children on the air conditioner or bracket. A serious injury may occur.
- Avoid fire hazard or electric shock. Do not use an extension cord or an adaptor plug. Do not remove any prongs from the power cord.
- Be sure the air conditioner is properly grounded. To minimize shock and fire hazards, proper grounding is important. The power cord is equipped with a three-prong grounding plug for protection against shock hazards.
- Your air conditioner must be used in a properly grounded wall receptacle. If the wall receptacle you intend to use is not adequately grounded or protected by a time delay fuse or circuit breaker, have a qualified electrician install the proper receptacle. Ensure the receptacle is accessible after the unit installation.
- Be sure the electrical service is adequate for the model you have chosen. This information can be found on the serial plate, which is located on the side of the cabinet and behind the grille.

CAUTION

- When the air filter is to be removed, do not touch the metal parts of the unit. It may cause injury.
- When the unit needs cleaning, switch off, and turn off the circuit breaker. Do not clean unit when power is on as it may cause fire, electric shock or injury.
- Do not place obstacles around air inlets or inside of air outlet. It may cause failure or accident.
- Clean with a soft cloth only. Do not use strong detergents that contain wax or thinners as it may damage the product.
- Use caution when unpacking and installing. Sharp edges could cause injury.
- Do not clean the air conditioner with water. Water may enter the unit and degrade the insulation which could lead to electric shock.

CAUTION

- Do not put a pet or house plant where it will be exposed to direct air flow. This could injure the pet or harm the plant.
- Hold the plug by the head of the power plug when taking it out. Otherwise, it may cause electric shock and damage.
- Ensure that the installation is properly secured to prevent the product from potentially falling.
- Do not place heavy objects on the power cord and ensure that the cord is not compressed. Otherwise, there is danger of fire or electric shock.
- If water is spilled on the unit, turn off the unit and switch off the circuit breaker. Isolate the unit by taking the power plug out and contact a service center.
- Do not use near gas stove or other gas burning appliances, as air flow may affect gas combustion.
- Do not use for any purpose other than room comfort.
- Do not use this air conditioner to preserve precision devices, food, pets, plants, and art objects. It may cause deterioration.
- Turn off the main power switch if the unit is not to be used for an extended time.
- Always insert the filters securely. Clean filter once every two weeks. Operation without filters may cause failure.
- Do not drink water drained from the air conditioner.

EXPLANATION OF SYMBOLS DISPLAYED ON THE UNIT

	WARNING	This symbol shows that this appliance used a flammable refrigerant. If the refrigerant is leaked and exposed to an external ignition source, there is a risk of fire.
	CAUTION	This symbol shows that the operation manual should be read carefully.
	CAUTION	This symbol shows that a service personnel should be handling this equipment with reference to the installation manual.
	CAUTION	This symbol shows that information is available such as the operating manual or installation manual.

WARNING (for using R32 refrigerant only)

- Do not try to accelerate the defrosting process or methods of cleaning that are not recommended by the manufacturer.
- The appliance shall be stored in a room without a continuously operating ignition source (for example, open flames or an operating gas appliance) or an ignition source (for example, an operating electric heater) close to the appliance. The appliance shall also be stored in a room without ignition sources.
- Do not pierce or burn.
- Be aware that the refrigerants may not contain an odor.
- Keep ventilation openings clear of obstruction.
- Unit is only to be serviced by a Midea authorized service, please contact a service center.
- Flammable refrigerant R32 is used within air conditioner. Please follow the instructions carefully to handle, install, clean, and service the air conditioner to avoid damage or hazard. Do not dispose of air conditioner in regular trash. Contact qualified agency for proper disposal.
- No open fire or devices that generate spark/arcing shall be around the air conditioner to avoid causing ignition of the flammable refrigerant used. Please follow the instructions carefully to store or maintain the air conditioner to prevent mechanical damage from occurring.



Caution: Risk of fire/flammable materials (Required for R32/R290 units only)



IMPORTANT NOTE: Read this manual carefully before installing or operating your new air conditioning unit. Make sure to save this manual for future reference.

Operation of Current Device

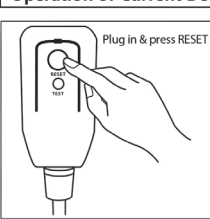

The power supply cord contains a current measuring device that detects damage to the power cord. Test your power supply cord as follows:

- Plug in the air conditioner.
- The power supply cord will have TWO buttons on the plug head. Press the TEST button. You will notice a click as the RESET button pops out.
- Press the RESET Button. You will notice a click as the button engages.
- The power supply cord is now supplying electricity to the unit. (On some products this is also indicated by a light on the plug head.)

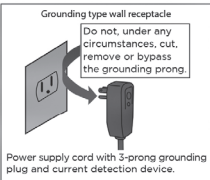

NOTICE

The power supply cord with this air conditioner contains a current detection device designed to reduce the risk of fire. In the event that the power supply cord is damaged, it can not be repaired. It must be replaced with a cord from the manufacturer.

NOTICE

- Do not use this device to turn the unit on or off.
- Always make sure the RESET button is pushed in for correct operation.
- The power supply cord must be replaced if it fails to reset when either the TEST button is pushed, or it can not be reset. Please contact a service center.

OPERATING INSTRUCTIONS

Preparation

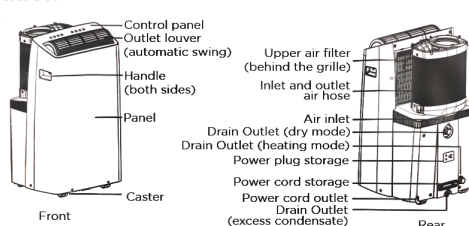

Unit operating Temperature Range:

Mode	Temperature Range
Cool	60°F - 95°F (16°C - 35°C)
Dry	55°F - 95°F (13°C - 35°C)
Heat Pump	41°F - 86°F (5°C - 30°C)

Control Panel Features

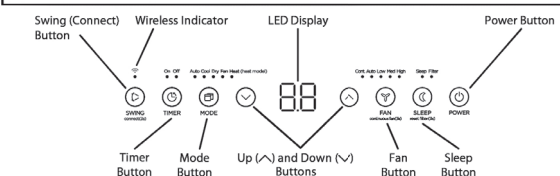

Swing Button

Used to initiate the Auto Swing feature. When the operation is ON, pressing the SWING button can stop the louvers at the desired angle.

Connect Button

The swing button is also used to initiate the wireless connection mode. To initiate the wireless connection mode, power on the air conditioner then press the SWING button for 3 seconds. The LED DISPLAY will show 'AP' to indicate the unit is in wireless connection mode. Refer to the app connection instructions to finish the connection process.

If the connection is successful, the unit will exit wireless connection mode and illuminate the wireless LED. If the connection fails, the unit will exit wireless connection mode automatically after 8 minutes and the wireless LED does not illuminate.

Note: The wireless connection process must be completed within 8 minutes after powering the air conditioner on.

Timer button

Used to initiate the AUTO ON start time and AUTO OFF stop time program. The timer on or off light will illuminate depending on the selected setting.

Fan button

Controls the fan speed. Press to control the fan speed in four steps - LOW, MID, HIGH and AUTO. The selected fan speed light will illuminate.

NOTE: Applicable to models with the Constant Fan feature. In COOL or DRY mode, press the Fan button for 3 seconds to turn on or off the constant fan function. When the function is turned on, the constant fan light will illuminate, indicating the fan will run constantly.

The LED Display will also show any error codes when they occur. Error codes will appear in the following format: Ehxx, Ecxx, Elxx, PCxx, PHxx, PLxx.

P1 - Bottom tray is full - Connect the drain hose and drain the collected water away. If protection code repeats, call for service.

When the function is turned off, the constant fan light will go out, indicating that the fan will stop when the compressor stops.

Mode button
Selects the desired operating mode. Each time you press the button, a mode is selected in a sequence that goes from AUTO, COOL, DRY, FAN and HEAT (Heat models only). The mode light illuminates and indicates the selected mode.

Up (^) and Down (v) buttons
Used to increase/decrease temperature settings in 1° increments in a range of 60°F/16°C to 86°F/30°C or the TIMER setting in a range of 0 ~ 24hrs.

To change between °F or °C, simultaneously press and hold the Up and Down buttons for 3 seconds.

Power button

Powers the unit on and off.

Sleep button

Used to initiate the SLEEP operation. Holding the Sleep button for 3 seconds will reset the filter light. The filter light will illuminate after 250 hours of operation to remind you to clean the filter.

LED display

Shows the set temperature in °F (Degrees Fahrenheit) or °C (Degrees Celsius) and the Auto-timer settings. While on FAN modes, it shows the room temperature.

NOTICE

Where the xx represents 2 numbers. The display will alternate displaying the two letter combination and the two number combination to identify the error. When an error occurs, restart the unit. If the error code still appears when the unit restarts, unplug the power cord and contact a service center.

The image shown here is for illustrative purposes only and may be subject to change. The actual descriptions of control panel and their locations may vary, depending on the model.

Operating Instructions

COOL operation

- Press the "MODE" button until the "COOL" indicator light comes on.
- Press the ADJUST buttons Up (^) or Down (v) to select your desired room temperature. The temperature can be set within a range of 60°F-86°F/16°C-30°C.
- Press the "FAN SPEED" button to choose the fan speed.

HEAT operation (Only for Heat Model)

- Press the "MODE" button until the "HEAT" indicator light comes on.
- Press the ADJUST buttons Up (^) or Down (v) to select your desired room temperature. The temperature can be set within a range of 60°F-86°F/16°C-30°C.
- Press the "FAN SPEED" button to choose the fan speed.
- When entering heat mode, the fan may start slower than expected. For some models, the fan speed cannot be adjusted while in HEAT mode.

DRY operation

- Press the "MODE" button until the "DRY" indicator light comes on.
- While in this mode, you cannot select a fan speed. The fan motor operates at AUTO speed.
- Keep windows and doors closed for the best dehumidifying effect.

AUTO operation

- When you set the air conditioner to AUTO mode, it will automatically select cooling, heating (Heat models only), or fan only operation depending on what temperature you have selected and the current room temperature.
- The air conditioner will control room temperature automatically according to the temperature point set by you.
- Under AUTO mode, you cannot select the fan speed.

SLEEP operation

Pressing this button will increase (during cooling operation) or decrease (during heating operation, applicable models) 2°F/1°C after 30 minutes. The temperature will again increase (cooling) or decrease (heating) by another 2°F/1°C after an additional 30 minutes. This new temperature will be maintained for 7 hours before returning to the originally selected temperature. This ends the Sleep mode and the unit will continue to operate as originally programmed.

FAN operation

- Press the "MODE" button until the "FAN" indicator light comes on.
- Press the "FAN SPEED" button to choose the fan speed. The temperature cannot be adjusted.
- Do not connect the duct to a window.

TIMER: Auto Start/Stop Operation

- When the unit is on, pressing the Timer button will initiate the Auto stop program.
- When the unit is off, press the Timer button to initiate the Auto start program. Pressing it again within five seconds will initiate the Auto stop program.
- Press or hold the Up (^) or Down (v) button to change the Auto time by 0.5 hour increments, up to 10 hours, then at 1 hour increments up to 24 hours. The control will count down the time remaining until start.
- The system will automatically revert back to display the previous temperature setting if there is no operation within 5 seconds.
- Turning the unit ON or OFF at any time or adjusting the timer setting to 0.0 will cancel the Auto Start/Stop timer program.
- Should a malfunction occur, the Auto Start/Stop timer program will also be cancelled.

NOTICE

The SLEEP operation feature is unavailable in FAN or DRY mode.

Other Features

COMFORT SENSE feature

This feature can ONLY be activated from the remote control. The remote control serves as a remote thermostat allowing for the precise temperature control at its location, which must be within 26 feet of the air conditioner. To activate the Comfort Sense feature, point the remote control towards the unit and press the set button to select. The remote's display will show the actual temperature at its location (as long as it is within the 26 feet of the air conditioner). The remote control will send this signal to the air conditioner every 3 minutes until the C-Sense function is selected again. If the unit does not receive the Comfort Sense signal during any 7 minutes interval, the unit will exit the Comfort Sense mode.

NOTE: This feature is unavailable under FAN or DRY mode.

AUTO-RESTART

If the unit shuts off unexpectedly due to a power outage, it will restart with the previously set function automatically when the power resumes.

WAIT 3 MINUTES BEFORE RESUMING OPERATION

After the unit has stopped, it cannot be restarted until 3 minutes time has elapsed. This is to protect the unit. Operation will automatically resume after 3 minutes.

AIRFLOW DIRECTION ADJUSTMENT

The louvers can be adjusted automatically using the SWING button.

- When the Power is ON, the louvers opens fully.
- Press the SWING button on the panel or remote controller to initiate the Auto Swing feature. The louvers will swing up and down automatically.
- Please do not adjust the louvers manually.

INSTALLATION INSTRUCTIONS

Choosing the Right Location



Your installation location should meet the following requirements:

- Make sure that you install your unit on an even surface to minimize noise and vibration.
- The unit must be installed near a grounded plug, and the Collection Tray Drain (found on the back of the unit) must be accessible.
- The unit should be located at least 9.8" (25cm) from the nearest wall to ensure proper air conditioning.
- DO NOT cover the Intakes, Outlets or Remote Signal Receptor of the unit, as this could cause damage to the unit.

Recommended Installation



NOTICE

The appearance of your unit might be slightly different.

WARNING

- This air-conditioning unit is a hermetically sealed unit that contains fluorinated gases. For specific information on the type of gas and the amount, please refer to the relevant label on the unit itself.
- Service, maintenance or repair of this unit must be performed by a certified technician.
- Product recycling must be done according to local regulations.

Scan this QR code to watch an installation video for your Midea portable air conditioner:



Tools Needed (Not included)

- Phillips screwdriver
- Tape measure or ruler
- Knife or scissors
- Saw (optional, to shorten window adaptor for narrow windows).

Accessories

Your Window Installation Kit fits windows 19.05"-63.86" (48.4-162.2 cm). Please doublecheck all packaging materials to make sure accessories do not get accidentally thrown away.

Part	Description
	Air exhaust adapter
	Bolt
	Window Sliders
	Sliding Window Adapter - Front
	Sliding Window Adapter - Rear
	Sliding Window Adapter - Air Divider
	Power Cord Buckle (for cooling only model)
	Foam seal A/B (adhesive)
	Foam seal C (Non-adhesive)
	Security bracket and 2 screws
	Drain hose
	Remote controller
	Screw

Window Installation Kit



1: For Hung Window types only

Insert the Air Exhaust Adapter into the exhaust of the hose (the circle opening) for optimal performance. Rotate the adapter clockwise until the locking tabs click and no longer rotates. Skip this step if installing into a horizontal sliding window. The Air Exhaust adapter may interfere with some window screens, and can be removed if desired (Please note this may slightly decrease performance).

2: Preparing the adjustable window slider

- Depending on the size of your window, adjust the size of the window slider. Use the combination of panels that best fits your window opening.
- If the length of the window requires two or more window sliders, use the bolt to fasten the window sliders once they are adjusted to the proper length.
- If installing in a sliding window, bolts should be installed on both sides of the window sliders.

NOTICE

Once the Exhaust Hose assembly and Adjustable Window Slider are prepared, choose from one of the following two installation methods.

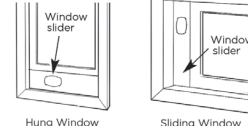

Type 1: Hung window installation

- Cut the adhesive foam seal A / B strip to the proper lengths, and attach them to the window sash and frame as shown.

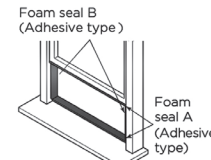

- Cut the non-adhesive foam seal C strip to match the width of the window. Insert the seal between the glass and the window frame to prevent air and insects from getting into the room.

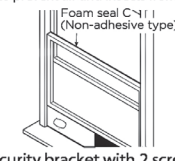

- If desired, install the security bracket with 2 screws as shown.



- Attach the hose to the window slider panel by inserting the end of the hose into the opening on the slider.



Type 2: Sliding window Installation (Optional)

- Cut the adhesive foam seal A and B strips to the proper lengths, and attach them to the window sash and frame as shown.
- Assembling the Sliding Window Adapter (Only needed for Sliding Window applications): Align both halves of the sliding window adapter and connect them. Then, attach the air divider to the newly formed window adapter on the outdoor side. The fully assembled adapter should look like the image at the left.
- Insert the window slider assembly into the window track. If the hose opening is covered by the window frame, rotate the panel so the thicker side faces the window frame.
- Be sure bolts are installed in both sides of the window slider for improved rigidity.
- Cut the non-adhesive foam seal C strip to match the window height. Insert the foam seal between the glass and the window frame to prevent air and insects from getting into the room.
- If desired, install the security bracket with 2 screws as shown.
- Attach the Sliding Window Adapter to the hose by lining up the circles on the adapter the hose. Insert the window slider adapter into the hole of the window slider.

NOTICE

To ensure proper function, DO NOT overextend or bend the hose. Make sure that there are no objects within 20in (~500mm) of the inlet and outlet hose. All illustrations in this manual are for explanation purposes only, your air conditioner may be slightly different than this manual.

Water Drainage

- Remove the upper drain plug
- Continuous drain hose
- During Dry modes, remove the upper drain plug from the back of the unit and install the drain hose. For models without drain connector, just attach the drain hose to the hole. Place the end of the hose directly in the drain area you're using.

Water Drainage (For Heating Mode)

- While operating in heat pump mode, the unit will produce condensate that must be drained. You must install the drain hose when operating in heat mode. To install the drain hose, remove the plug from the drain port and attach the included hose. The universal drain adaptor (not included) can be attached to the end of the included hose. A 3/4" hose (not included) can be attached to the adaptor if a longer hose length is required. Place the end of the hose in the drain area you are using.

- NOTICE**
- Because this unit contains a condensate pump, the drain hose can be elevated up to 6 ft. (1.8 m). Direct the hose toward the drain, making sure there are no kinks that will restrict water flow. Make sure the end of the hose is directed downward (see fig. 1) with check mark symbol). The figure with (X) symbol is not recommended as the end of the hose is not directed downward. When the continuous drain hose is not used, ensure that the corresponding drain plug and knob are installed firmly to prevent leaks.

- Remove the middle drain plug
- Continuous drain hose
- Delivery lift is 6ft
- Press the power cord buckle into the rear cover.

- When the water level of the bottom tray reaches a predetermined level, the unit beeps 8 times. The digital display shows "P1." At this time the air conditioning/dehumidification process will immediately stop. However, the fan motor will continue to operate (this is normal). Carefully move the unit to a drain location, remove the bottom drain plug and let the water drain away. Reinstall the bottom drain plug and restart the machine until the "P1" symbol disappears. If the error repeats, call for service.

- NOTICE**
- Be sure to reinstall the bottom drain plug firmly to prevent leakage before using the unit.

CARE AND CLEANING

Safety Precautions

- Always unplug the unit before cleaning or servicing.
- DO NOT use flammable liquids or chemicals to clean the unit.
- DO NOT wash the unit under running water. Doing so causes electrical danger.
- DO NOT operate the machine if the power supply was damaged during cleaning. A damaged power cord must be replaced with a new cord from the manufacturer.

Air Filter Cleaning

- Upper filter (take out)
- Be sure to clean the air filter every 2 weeks for optimal performance.
- Clean the filter using water and ensure it is dry before reinstalling.
- The water collection tray should be drained immediately after P1 error occurs, and before storage to prevent mold.
- In households with animals, you will have to periodically wipe down the grill to prevent blocked airflow due to animal hair.
- Notice the air filter is integrated with the removable grille cover.

Unit Cleaning

Clean with a soft cloth only. Do not use strong detergents that contain wax or thinners as it may damage the product

Store the Unit When Not in Use

- Drain the unit's water collection tray according to the instructions in the following section.
- Run the unit on FAN mode for 12 hours in a warm room to dry it and prevent mold.
- Turn off the unit and unplug it.
- Clean the air filter according to the instructions in the previous section. Reinstall the clean, dry filter before storing.
- Remove the batteries from the remote control.

NOTICE

Be sure to store the unit in a cool, dark place. Exposure to direct sunlight or extreme heat can shorten the lifespan of the unit.

TROUBLESHOOTING TIPS

Before calling service, review this list. It may save you time and expense. This list includes common occurrences that are not the result of defective workmanship or materials of this appliances.

Problem	Solution
Unit does not turn on when pressing ON/OFF button	Displays P1 Error Code and means the water collection tray is full. Turn off the unit, drain the water from the water collection tray, and restart the unit. If room temperature is lower than the set temperature in COOL mode, reset the temperature.
Unit does not cool well	The air filter is blocked with dust or animal hair. Turn off the unit and clean the filter according to the Instructions. Exhaust hose is not connected or is blocked. Turn off the unit, disconnect the hose, check for blockage and reconnect the hose. Temperature setting is too high; decrease the set temperature. Make sure all windows and doors are closed. The room area could be too large; doublecheck the cooling area. Check the room for possible heat sources and remove them if possible.

The unit is noisy and/or vibrates too much	The floor is not level. Place the unit on a flat, level surface. The air filter is blocked with dust or animal hair. Turn off the unit and clean the filter according to the instructions.
The unit makes a gurgling sound	This sound is caused by the refrigerant flow inside the unit and is normal.
Unit will not connect to Wireless or App does not work (some models)	For additional support and troubleshooting tips, follow the link in the QR code:
In heating mode, the fan speed is lower than expected.	It is normal for the fan speed to start low in heating mode. The fan speed should reach your desired setting after a few minutes of operation.

NOTICE

Do not add extension to the exhaust hose(s)

REMOTE CONTROL AND APP INSTRUCTIONS

Handling the Remote Control

LOCATION OF THE REMOTE CONTROL
Use the remote control within a distance of 26 ft. (8m) from the air conditioner, pointing it towards the unit. The unit will beep when it receives a signal.

CAUTION

- The air conditioner will not operate if curtains, doors or other materials block the signals from the remote control to the unit.
- Prevent any liquid from spilling onto the remote control. Do not expose the remote control to direct sunlight or heat.
- If the infrared signal receiver on the indoor unit is exposed to direct sunlight, the air conditioner may not function properly. Use curtains to prevent the sunlight from falling on the receiver.
- If other electrical appliances react to the remote control, either move these appliances or consult your local dealer.

Inserting and Replacing Batteries

Your air conditioning unit may come with two AAA batteries (some units). Put the batteries in the remote control before use.

- Slide the back cover from the remote control downward, exposing the battery compartment.
- Insert the batteries, paying attention to match up the (+) and (-) ends of the batteries with the symbols inside the battery compartment.
- Slide the battery cover back into place.

- BATTERY NOTES**
- For optimum product performance:
 - Do not mix old and new batteries, or batteries of different types.
 - Do not leave batteries in the remote control if you don't plan on using the device for more than 2 months.

BATTERY DISPOSAL

Ensure used batteries are disposed of properly.

TIPS FOR USING REMOTE CONTROL

- In order to properly transmit a command, the ON/OFF indicator must be illuminated on the remote's display. (See the Remote LED Screen Indicators section for more information.)

Remote Control Specifications

Model	RG10F2(B2)/BGFEU1 or RG10F3(B2)/BGFEU1
Rated Voltage	3.0V (Dry batteries R03/LR03x2)
Signal Receiving Range	26 ft (8 m)
Environment	-5 °C ~ 60 °C (23°F ~ 140°F)

Function Buttons

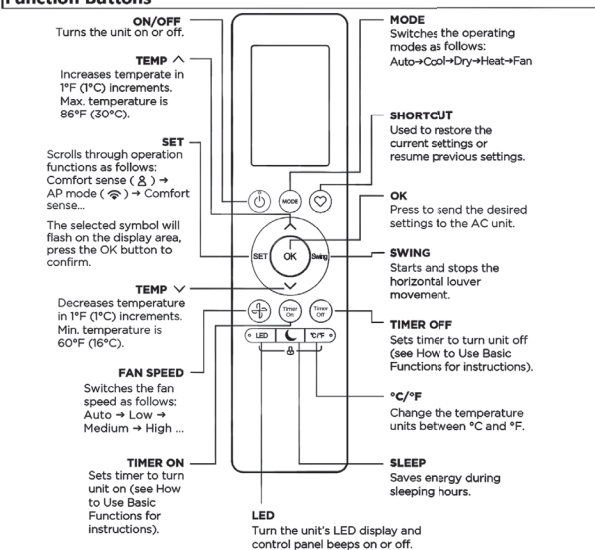

The remote control vary depend of model: The buttons on the remote control may have a different name or location than the remote control shows in this manual.

Remote Screen Indicators

Information is displayed when the remote control is powered on.

- Fresh feature display (Not applicable)
- Sleep mode display
- Comfort sense feature display
- Wireless control feature display
- Low battery detection display (if flashes)

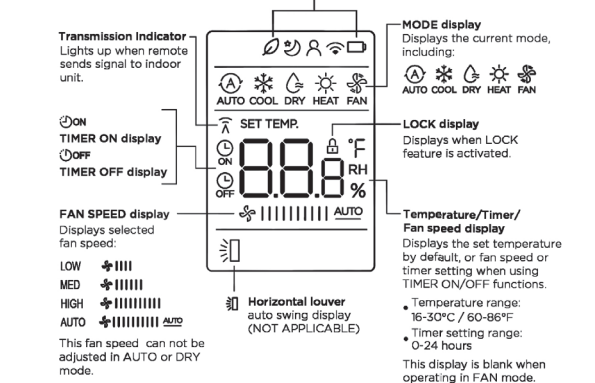

The image shown here is for illustrative purposes only and may be subject to change. The actual descriptions of control panel and their locations may vary, depending on the model.

Setting the Timer

TIMER ON/OFF - Set the amount of time after which the unit will automatically turn on/off.

TIMER ON SETTING

- Press **TIMER ON** button to initiate the ON time sequence.
- Press up or down button for multiple times to set the desired time to turn on the unit.

- Point remote to unit and wait 1sec, the **TIMER ON** will be activated.

TIMER OFF SETTING

- Press **TIMER OFF** button to initiate the OFF time sequence.
- Press up or down button for multiple times to set the desired time to turn off the unit.

- Point remote to unit and wait 1sec, the **TIMER OFF** will be activated.

NOTICE

- When setting the **TIMER ON** or **TIMER OFF**, the time will increase by 30 minutes increments with each press, up to 10 hours. After 10 hours and up to 24, it will increase in 1 hour increments. (For example, press 5 times to get 2.5h, and press 10 times to get 5h.). The timer will revert to 0.0 after 24.
- Cancel either function by setting its timer to 0.0h.

TIMER ON & OFF setting (example)

Keep in mind that the time periods you set for both functions refer to hours after the current time.

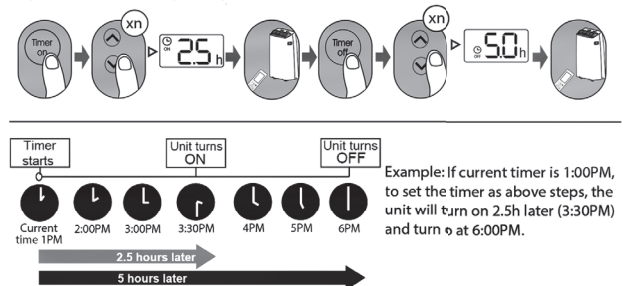

DECLARATION OF CONFORMITY

We hereby declare that this AC is in compliance with the essential requirements and other relevant provisions of Directive 1999/5/EC.

SPECIFICATION OF WIRELESS MODULE

Model: US-SK105	Dimensions: 41 x 24 x 5 (mm)
Standard: IEEE 802.11 b/g/n	Operation Temperature: 0°C ~ 45°C / 32°F ~ 113°F
Antenna Type: Printed PCB Antenna	Operation Humidity: 10% ~ 85%
Frequency: 2400-2483.5MHz	Power Input: DC 5V/300 mA
Maximum Transmitted Power: <20 dBm Max	

PRECAUTIONS

- Supports operating systems: iOS 7+ or Android 4+.
- In the event of a OS update, there may be a delay between the update of the OS and a related software update during which your OS may or may not be supported until a new version is released. Your specific mobile phone or problems in your network may prevent the system from working and Midea will not be responsible for any problems that could be caused by incompatibility or network issues.
- This Smart AC only supports WPA-PSK/WPA2-PSK (recommended) encryption.
- To ensure proper scanning of the QR code, your smart phone must have at least a 5-megapixel camera.
- Due to unstable network connectivity, requests may time out. If this happens, re-run the network configuration.
- Due to unstable network connectivity, commands may time out. If this happens, the smartphone app and the actual product may display conflicting information. The information displayed on the actual product is always the most accurate available. Refresh the app to re-sync.

NOTICE

Midea will not be responsible for any problems that could be caused by ncompatibility or network issues, your wireless router and mobile phone.

SYSTEM OVERVIEW

Devices required to use the Smart AC:

- Smart Phone with compatible iOS or Android system.
- Wireless Router (a 2.4GHz network is required to connect).
- Smart Air Conditioner.

DOWNLOAD AND INSTALL THE APP

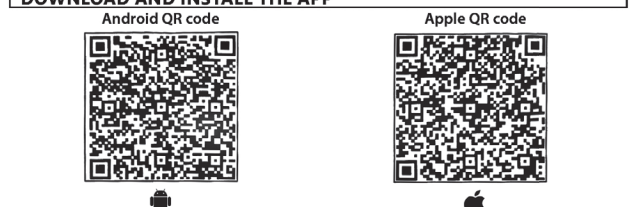

Scan to download app.
You can also go to Google Play or App Store and search for Midea Air.

NOTICE

All the images in this manual are for reference only, your product and app may look slightly different. The actual product and app instructions have to be considered.

ADDITIONAL APP AND SMART HOME FUNCTIONS

For additional instructions regarding the features of the app and Smart Home skill capabilities, scan the QR code below.



REFURBISHED PRODUCT LIMITED THIRTY DAY WARRANTY

The **Refurbished Product Service Center** offers the following **WARRANTY** to the ORIGINAL purchaser of a product which we have refurbished.

This product that has been refurbished is warranted against any electronic or mechanical defects for a period of **THIRTY DAYS** from the date of the original purchase by the consumer. Since this unit was sold as a refurbished item, the warranty does not apply to any cosmetic appearance items such as scratches. Should a defect occur, the **Refurbished Product Service Center** will repair or, at its option, replace defective unit/parts with new or rebuilt materials without charge for either parts or labor. Replacement unit/parts will be warranted for the remaining portion of the original warranty period.

This warranty does not cover installation or damage from accident, misuse, abuse, improper wiring, incorrect voltage, operating the unit against the instructions in the owner's manual or any product which has been opened, altered, or tampered with.

This warranty does not cover costs for removal and/or installation of the unit for repair. Under no circumstances shall the service center be liable for any special, incidental or consequential damages or for any other expenses incurred by reason of use or sale of this product. This warranty is in lieu of any other warranties expressed or implied warranty of merchantability of fitness for particular use or otherwise.

This warranty gives the consumer specific legal rights and they may also have other rights which vary from State to State. Some States do not follow the exclusion or limitation of incidental or consequential damages, hence the above exclusion and limitations may not apply.

Refurbished Product Service Center
13225 Marquardt Avenue Santa Fe Springs, CA 90670

WARRANTY REPAIR INFORMATION

If you need service on your unit during the 30 day warranty period; please go to www.ConsumerServiceRefurbish.com or call the Refurbished Product Service Center at 562-946-3531 to obtain the required claim number. Once you obtain your claim number, pack the unit properly (the original carton is ideal for this purpose) along with a copy of your purchase receipt. Send the unit freight prepaid and insured to:

Refurbished Product Service Center,
Attn: Customer Service Department 13225 Marquardt Avenue Santa Fe Springs, CA 90670

Your unit will be promptly exchanged and returned to you. We will refuse to accept delivery of the returned unit unless the assigned claim number appears on the outside of the shipping carton.

Owner's Information
(Keep for your permanent records)

NAME: _____ ADDRESS: _____

CITY: _____ STATE: _____ ZIP CODE: _____

PHONE: _____ E-MAIL: _____

MODEL: _____ SERIAL NO.: _____

PRINTED IN MEXICO
Elbrd: A.M
SC: 07-25-2022_TAB
MODEL: MAP14HSITWT
OBPN: 16120600A22747



804106832

