

Shark Navigator[®] Lift-Away[®] Upright Vacuum

NV350 Series

OWNER'S GUIDE



IMPORTANT SAFETY INSTRUCTIONS

HOUSEHOLD USE ONLY

To reduce the risk of electric shock, this vacuum cleaner has a polarized plug (one blade is wider than the other). As a safety feature, this plug will fit into a polarized outlet only one way. If the plug does not fit fully into the outlet, reverse the plug. If it still does not fit, contact a qualified electrician. **DO NOT force into outlet or try to modify to fit.**

⚠ WARNING

TO REDUCE THE RISK OF FIRE, ELECTRIC SHOCK OR INJURY:

When using an electrical appliance, basic precautions should always be followed, including the following:

- Your vacuum cleaner may consist of a motorized nozzle, wand, hose, and/or vacuum pod. This device contains electrical connections, electrical wiring, and moving parts that potentially present risk to the user.
- Use only identical replacement parts.
- Carefully observe and follow the instructions provided below to avoid improper use of the appliance. **DO NOT** use the vacuum for any purpose other than those described in this manual.
- Before use, carefully inspect all parts for any damage. **DO NOT** use if any parts are damaged.
- The use of an extension cord is **NOT** recommended.
- This vacuum cleaner contains no serviceable parts.

USE WARNINGS

- **DO NOT** allow the appliance to be used by children. Close supervision is necessary when used near children. This is not a toy.
- Always turn off the vacuum cleaner before connecting or disconnecting any motorized nozzles or other accessories.
- **DO NOT** handle plug or vacuum cleaner with wet hands.
- **DO NOT** use without filters in place.

- Only use Shark® branded filters and accessories.
- **DO NOT** damage the power cord:
 - a) **DO NOT** pull or carry vacuum cleaner by the cord or use the cord as a handle.
 - b) **DO NOT** unplug by pulling on cord. Grasp the plug, not the cord.
 - c) **DO NOT** run the vacuum cleaner over the power cord, close a door on the cord, pull the cord around sharp corners, or leave the cord near heated surfaces.
- **DO NOT** put any objects into nozzle or accessory openings. **DO NOT** use with any opening blocked; keep free of dust, lint, hair, and anything that may reduce airflow.
- **DO NOT** use if nozzle or accessory airflow is restricted. If the air paths or the motorized floor nozzle become blocked, turn the vacuum cleaner off and unplug from electrical outlet. Remove all obstructions before you plug in and turn on the unit again.
- Keep nozzle and all vacuum openings away from hair, face, fingers, uncovered feet, or loose clothing.
- **DO NOT** use if vacuum cleaner is not working as it should, or has been dropped, damaged, left outdoors, or dropped into water.
- Use extra care when cleaning on stairs.

SAVE THESE INSTRUCTIONS

READ ALL INSTRUCTIONS BEFORE USE

- **DO NOT** leave the vacuum cleaner unattended while plugged in.
- When powered on, keep the vacuum cleaner moving over the carpet surface at all times to avoid damaging the carpet fibers.
- **DO NOT** place vacuum cleaner on unstable surfaces such as chairs or tables.
- Your Shark® vacuum may not be designed to stand up on its own. When taking a break from cleaning, you may need to lean it against furniture or a wall, or lay it flat on the floor. Using the vacuum for an application where the unit lacks stability may result in personal injury.
- **DO NOT** use to pick up:
 - a) Liquids
 - b) Large objects
 - c) Hard or sharp objects (glass, nails, screws, or coins)
 - d) Large quantities of dust (drywall dust, fireplace ash, or embers). **DO NOT** use as an attachment to power tools for dust collection.
 - e) Smoking or burning objects (hot coals, cigarette butts, or matches)
 - f) Flammable or combustible materials (lighter fluid, gasoline, or kerosene)
 - g) Toxic materials (chlorine bleach, ammonia, or drain cleaner)
- **DO NOT** use in the following areas:
 - a) Poorly lit areas
 - b) Wet or damp surfaces
 - c) Outdoor areas
 - d) Spaces that are enclosed and may contain explosive or toxic fumes or vapors (lighter fluid, gasoline, kerosene, paint, paint thinners, mothproofing substances, or flammable dust)
- Turn off all controls before plugging in or unplugging the vacuum.
- Unplug from electrical outlet when not in use and before any maintenance or cleaning.
- Hand wash with water only. Washing with cleaning chemicals could damage the unit.
- During cleaning or routine maintenance, **DO NOT** cut anything other than hair, fibers, or string wrapped around the brushroll.
- Allow all filters to air-dry completely before replacing in the vacuum to prevent liquid from being drawn into electric parts.
- Make sure the dust cup and all filters are in place after routine maintenance.
- If provided, secure the power cord around the two cord hooks during storage.

SAVE THESE INSTRUCTIONS

Use your Shark Navigator® Lift-Away® in upright mode, or lift away the pod to clean hard-to-reach areas above the floor.

TECHNICAL SPECIFICATIONS

Voltage: 120V, 60Hz

PLEASE READ CAREFULLY AND KEEP FOR FUTURE REFERENCE.

This Owner's Guide is designed to help you get a complete understanding of your new Shark Vacuum.

Accessory type and quantity may vary depending on the model.

Getting Started

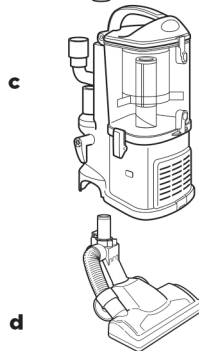
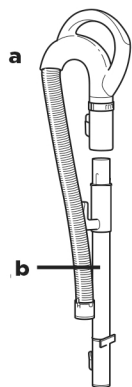

- a** Handle with Stretch Hose
- b** Wand
- c** Detachable Pod
- d** Motorized Floor Nozzle

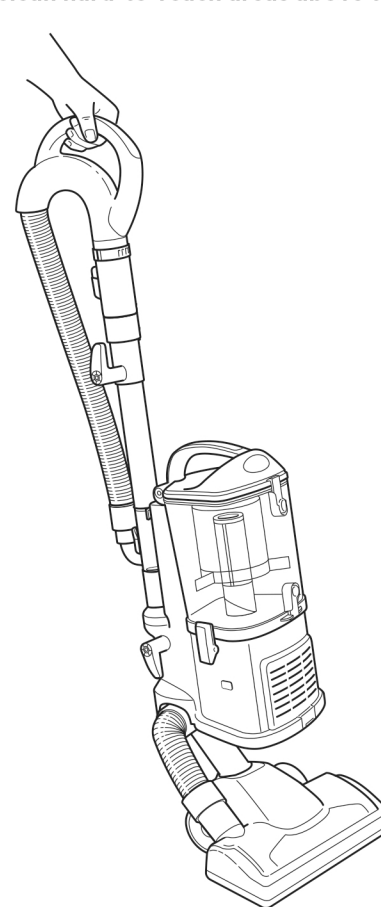

Fig. 6

1 UPRIGHT MODE

Upright vacuuming for cleaning both floors and carpets. **(Fig. 6)**

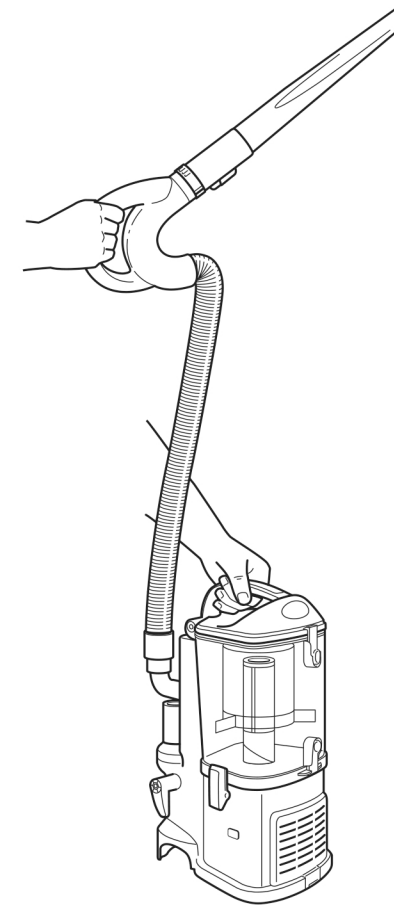

Fig. 7

2 LIFT-AWAY® MODE

Lift off the pod to clean hard-to-reach areas. **(Fig. 7)**

THIS MANUAL COVERS MODEL NUMBERS:

NV351
NV351WM1
NV351WM2
NV352
NV352B
NV353

Upright Mode

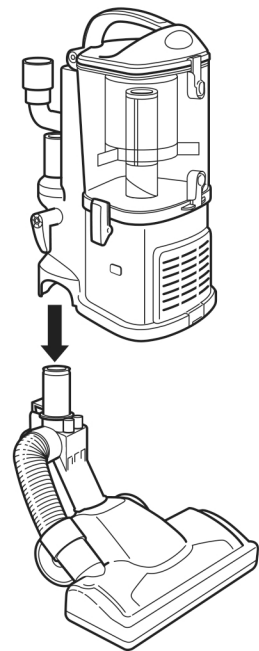

Fig. 8

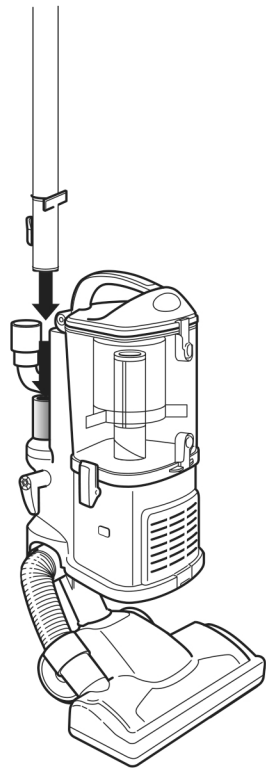

Fig. 9

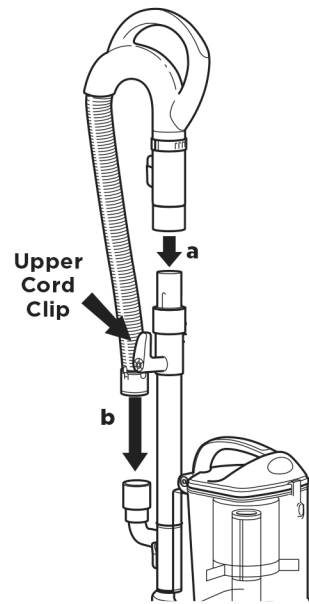

Fig. 10

ASSEMBLING YOUR VACUUM

- 1 Place the floor nozzle on a level surface.
- 2 Align the detachable pod over the tube on the floor nozzle. Lower the pod onto the floor nozzle until it clicks securely into place. **(Fig. 8)**
- 3 Insert the wand into the tube on the back of the pod, pressing until it clicks securely into place.

- 4 Push the handle **(a)** onto the top of the wand until it clicks into place. **(Fig. 10)**
- 5 Insert the end of the stretch hose **(b)** into the connector on the back of the pod. **(Fig. 10)**

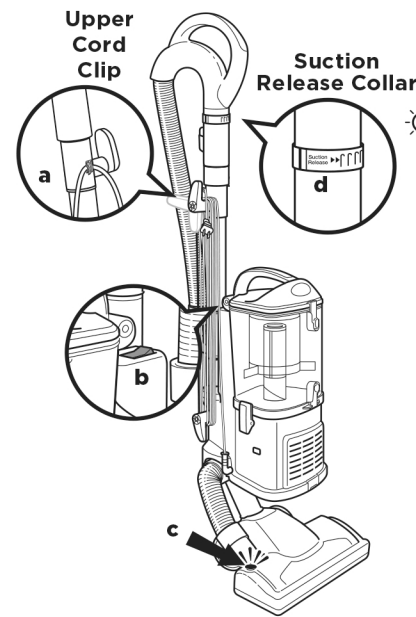

Fig. 11

Adjust the suction release collar to reduce suction for easier push and pull on thick carpets and area rugs.

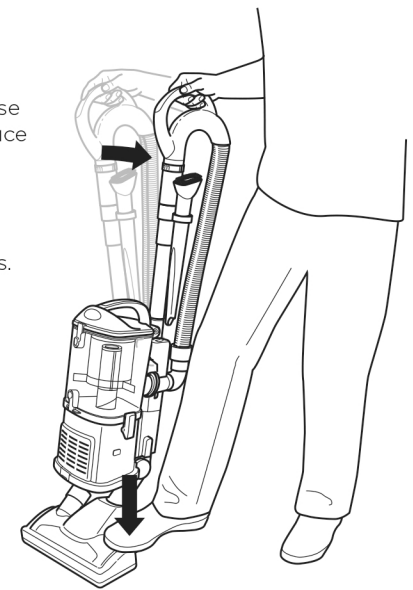

Fig. 12

POWER CORD:

- 1 Rotate the upper cord clip to quickly release the power cord.
- 2 Secure the power cord by wrapping it around the cord clips **(a)**. **(Fig. 11)**

SETTINGS:

|| = Brushroll On

| = Bare Floor

○ = OFF



- 3 Press the selector switch **(b)** to Setting I to vacuum bare floors (straight suction only) or to Setting II to engage the brushroll (for vacuuming carpets and rugs). **(Fig. 11)**

Brushroll Indicator Light: The brushroll indicator light **(c)** will illuminate green when the brushroll is on, or red if there is a blockage or jam. **(Fig. 11)** This feature is designed to protect the brushroll. See Checking for Blockages.

- 4 To activate the brushroll, step lightly on the floor nozzle, then tilt the handle back. **(Fig. 12)**

NOTE: The brushroll will not spin unless the nozzle is flat against the floor and the handle is tilted back.

- 5 Increase or decrease suction power by adjusting the suction release collar **(d)** on the handle. **(Fig. 11)** If the vacuum seems difficult to push or pull or if it is lifting up area rugs, reduce suction by rotating the collar counterclockwise. To increase suction and to vacuum floors, rotate the collar clockwise.
- 6 Empty dust cup after vacuuming and periodically during use when it appears full. (See Maintenance section for instructions.)
- 7 When you are finished vacuuming, move the switch to the Off position.

Lift-Away® Mode

 Use the handle on top of the dust cup to easily lift and carry the pod.

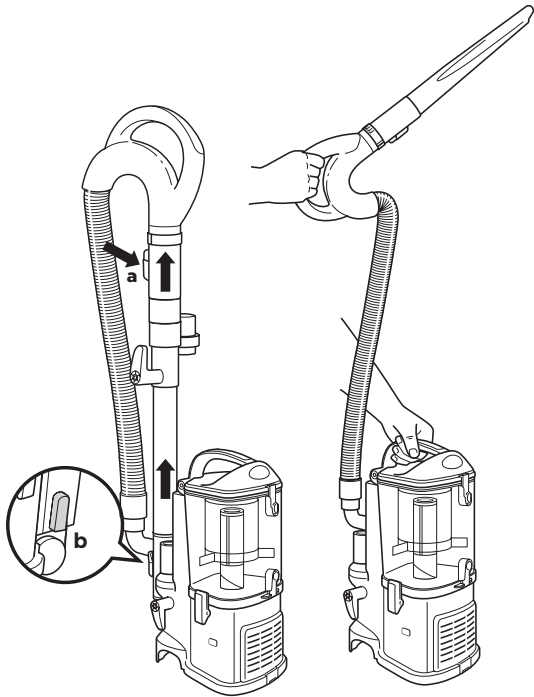
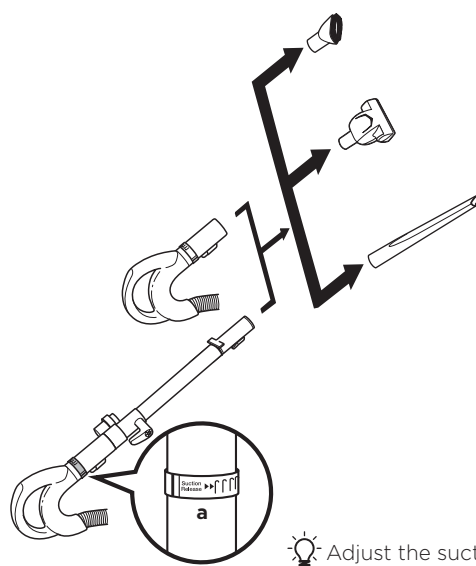

Fig. 13

Fig. 14

- 1 Press the Lift-Away button **(b)**, then lift the pod off the floor nozzle. **(Fig. 13)**
- 2 To clean with the handle, press the Handle Release button **(a)** and lift the handle out of the wand. To clean with longer reach, press the Wand Release button and lift off the wand. **(Fig. 14)**
- 3 Attach desired accessory onto the end of either the wand or the handle.
- 4 Move the selector switch to Setting I (Bare Floor) for above-floor cleaning.

Above-Floor Cleaning



Suction Release Collar

 Adjust the suction release collar to reduce suction for easier push and pull on thick carpets and area rugs.

Fig. 15

- 1 Press the handle release button to detach the handle or press the wand release button to detach the wand.
- 2 Attach desired accessory onto the end of either the wand or the handle. **(Fig. 15)**
- 3 Move the selector switch to Setting I for above-floor cleaning.

Lift-Away® Cleaning with Floor Nozzle

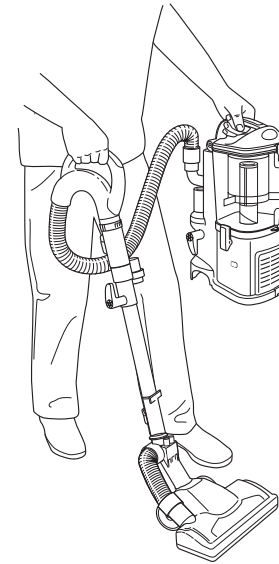

Fig. 16

- 1 Press the Lift-Away button and lift off the pod.
- 2 Attach the floor nozzle onto the end of the wand. **(Fig. 16)**
- 3 Move the selector switch to Setting I to turn on power.

NOTE: The brushroll will not spin in Lift-Away mode.

Storage

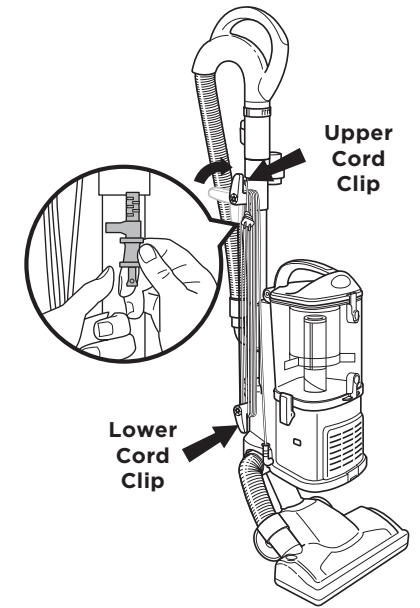

Fig. 17

- 1 Attach pod to floor nozzle to go into upright mode.
- 2 Rotate the upper cord clip to its upright position and coil the power cord loosely around the two clips. Clip the plug onto the cord to secure. **(Fig. 17)**
- 3 Store the dusting brush and the crevice tool on the mounts on the accessory holder.
- 4 Store your vacuum cleaner safely in a cool, dry area where it will not be a hazard, will not be damaged, and will not cause damage to anyone or anything.

NOTE: Empty dust cup after cleaning and prior to storing. (See Maintenance section for instructions.)

Maintenance

COMPONENT	MAINTENANCE SCHEDULE
1 Pre-Motor Foam and Felt Filters	Rinse and air-dry every 3 months under normal use.
2 Post-Motor HEPA Filter	Clean once every year or as needed.

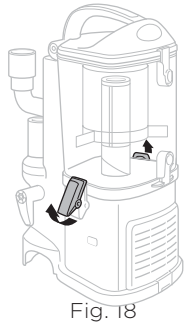

Fig. 18

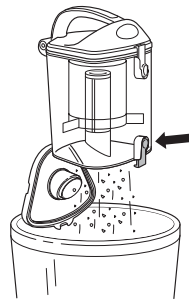

Fig. 19

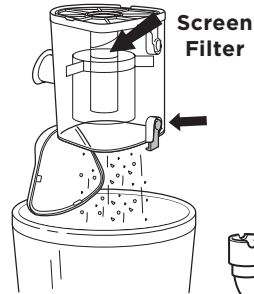

Fig. 20

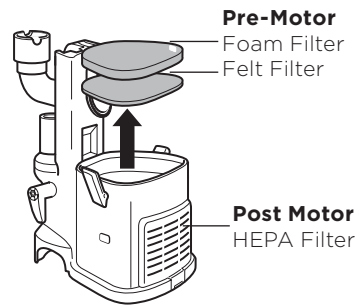

Fig. 21

Emptying The Dust Cup

The dust cup needs to be emptied each time you vacuum and periodically during cleaning, when the dust cup appears full.

- 1 Remove the dust cup by lifting the side latches. **(Fig. 18)**
- 2 Hold the dust cup over a trash receptacle and press the bottom door release button. **(Fig. 19)** Tap gently to empty contents. Press the door shut again until it clicks into place.
- 3 If needed, turn the dust cup upside down over the trash receptacle and press the top door release button. **(Fig. 20)** Tap gently to remove contents.
- 4 Replace the dust cup on top of the pod. Hook the two latches onto the tabs on the sides of the dust cup and push down to lock.

Cleaning The Pre-Motor Filters

- 1 Remove the dust cup.
- 2 Pull the 2 filters out from the top of the pod. **(Fig. 21)**
- 3 Rinse the filters thoroughly in lukewarm water until the water runs clear.

NOTE: Filter material will discolor over time. This is normal, and will not affect performance.
- 4 Squeeze out excess water and let air-dry for at least 24 hours before replacing. **DO NOT** use a hair dryer or other heating methods to dry.
- 5 Reinsert the felt filter first, then the foam filter.
- 6 Replace the dust cup.

Maintenance - cont'd

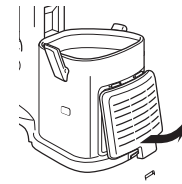

Fig. 22

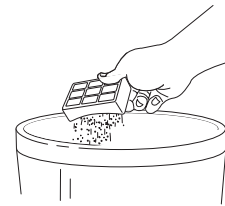

Fig. 23

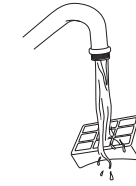

Fig. 24

Cleaning The Post-Motor HEPA Filter

- 1 To access the HEPA filter, lift the tab on the filter cover and remove the cover. **(Fig. 22)**
- 2 Pull the HEPA filter straight out.
- 3 Turn the filter over so that the dirty side is on the bottom. Tap it vigorously against the inside of a trash receptacle to knock off any dust. **(Fig. 23)**
- 4 With the dirty side down, rinse the HEPA filter with lukewarm tap water until the water runs clear. **(Fig. 24)**
- 5 Allow the filter to air-dry for 24 hours. **DO NOT** use a hair dryer or other heating methods to dry.
- 6 When the HEPA filter is completely dry, reinstall it.
- 7 Replace the cover by inserting the two tabs into the holes at the top and then swinging the cover down until it clicks into place.

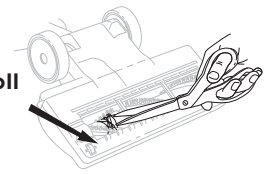

Fig. 25

Brushroll

CLEANING THE BRUSHROLL

When your brushroll needs cleaning or locks onto an object, it will automatically shut down. The indicator light will illuminate red, warning you to turn off the vacuum and clear the blockage immediately. The light will reset once the blockage has been cleared and power has been cycled on or off, or the vacuum has been locked in the upright position.

- 1 Detach the motorized floor nozzle from the pod.
- 2 Inspect the airway and the brushroll. Remove any debris buildup. With scissors, carefully cut away any fibers or hair wrapped around the brushroll. Avoid damaging or cutting the bristles. **(Fig. 25)**

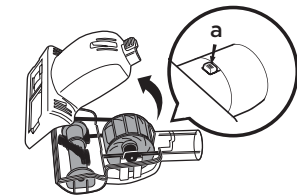

Fig. 26

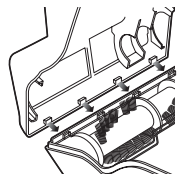

Fig. 27

Cleaning The Pet Power Brush

- 1 Slide the locking latch **(a)** forward and lift off the brushroll housing. **(Fig. 26)**
- 2 Carefully remove any blockage or debris. Use scissors to cut away any hair or string wrapped around the brushroll.
- 3 To reassemble, insert the tabs on the front edge of the brushroll housing into the matching holes in the top half and tilt it back down until it clicks into place. **(Fig. 27)**



Make sure you are working in a well-lit area and use a flashlight to help search for blockages.

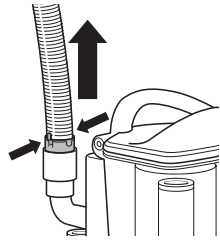

Fig. 28

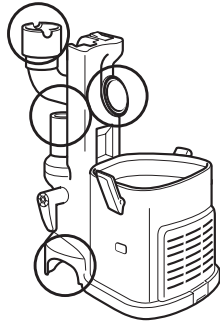

Fig. 29

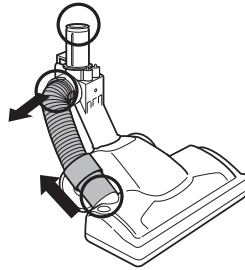

Fig. 30

Checking For Blockages

Blockages may cause your vacuum to overheat and shut down. To prevent this from happening, check potential blockage areas after heavy use, or if you detect a loss of suction or poor cleaning performance.

1 Dust Cup

Dust cup may be full. Empty dust cup.

2 Pre-Motor & Post-Motor Filters

Pre-motor filters require washing every 3 months for optimum performance. The post-motor HEPA filter needs to be washed every 2 years.

Ensure that all the filters are clean.

3 Accessories

- Check intake openings in all accessories.

4 Hose and Connections to Vacuum

- Detach the stretch hose from the back of the pod by squeezing the tabs together and pulling up. (Fig. 28) Straighten out the hose and look inside for blockages.
- Remove the dust cup and wand and detach the pod from the motorized floor nozzle. Check all openings for any blockages. (Fig. 29)

5 Motorized Floor Nozzle

- Detach the hose from the motorized floor nozzle. Pull the bottom of the hose out of the connector, and release the top of the hose by squeezing the tabs together. Check the hose and the openings for blockages. (Fig. 30)

Troubleshooting Guide

PROBLEM	POSSIBLE REASONS & SOLUTIONS
Vacuum is not picking up dirt.	<p>Check filters to see if they need cleaning. Follow instructions for rinsing and drying the filters before reinserting back into the vacuum. (See Maintenance sections for instructions.)</p> <p>Dust cup may be full; empty dust cup.</p> <p>Check hose and hose connections for blockages; clear blockages if required. If dust cup is empty, and attachment inlets are clear, check for other blockages. (See Checking for Blockages for instructions.)</p>
Vacuum lifts area rugs (lightweight, movable rugs).	<p>Suction is powerful. Take care when vacuuming area rugs or rugs with delicately sewn edges. Rotate the suction release collar on the handle counterclockwise to decrease suction power.</p> <p>Move the selector switch to Setting I (Bare Floor) to disengage the brushroll.</p>
Airflow is restricted. No suction or light suction.	<p>Check filters to see if they need cleaning. Follow instructions for rinsing and drying the filters before reinserting back into the vacuum.</p> <p>Dust cup may be full; empty dust cup.</p> <p>Check hose, hose connections, nozzles, and accessories for blockages; clear blockages if required.</p> <p>Rotate the suction release collar on the handle clockwise to increase suction power.</p> <p>If dust cup is empty, and attachment inlets are clear, check for other blockages.</p>
Brushroll does not spin.	<p>Immediately turn off and unplug vacuum, disconnect the nozzle, and remove any blockages before reconnecting and turning vacuum back on. Step lightly on the floor nozzle and tilt the handle back to engage the brushroll.</p> <p>Move the selector switch to Setting II (Brushroll On).</p>
Vacuum turns off on its own or indicator light flashes red.	<p>This vacuum cleaner is equipped with a motor protective thermostat. If your vacuum overheats, the thermostat will automatically turn the suction motor off. Perform the following steps to restart the thermostat:</p> <ol style="list-style-type: none"> 1. Turn vacuum off and unplug it. 2. Empty dust cup and clean filters. 3. Check for blockages in hose, accessories, and inlet openings. 4. Allow unit to cool for a minimum of 45 minutes. 5. Plug in vacuum and restart by moving the selector switch to Setting I (Bare Floor). <p>NOTE: If vacuum still does not start, contact a service center.</p>



The image shown here is for illustrative purposes only and may be subject to change.

PLEASE READ CAREFULLY AND KEEP FOR FUTURE REFERENCE.

This Owner's Guide is designed to help you get a complete understanding of your new Shark Navigator® Lift-Away® Upright Vacuum.

SharkNinja Operating LLC

Illustrations may differ from actual product. We are constantly striving to improve our products; therefore the specifications contained herein are subject to change without notice.

For SharkNinja U.S. Patent information, visit sharkninja.com/uspatents

© 2020 SharkNinja Operating LLC. LIFT-AWAY, SHARK, and SHARK NAVIGATOR are registered trademarks of SharkNinja Operating LLC.



Please be sure to read the enclosed Shark® Owner's Guide prior to using your unit.

QUICK START GUIDE

WHAT'S INSIDE:

- (A) Vacuum Pod
- (B) Floor Nozzle
- (C) Extension Wand
- (D) Handle and Hose
- (E) Pet Power Brush

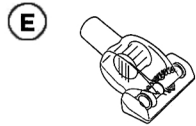

ASSEMBLY

ASSEMBLY:

1. Insert **Pod** into floor nozzle.
2. Insert **Wand** into the pod.
3. Insert **Handle** into wand, pressing until it clicks into place.

4. Connect **Hose** to back of pod, pressing until it clicks into place.

For proper operation, ensure all parts are firmly clicked into place.

