

VIZIO | Quick Setup Guide

Please read these instructions completely before operating this product.

805008809

To download your copy of the complete Owner's Manual:

<http://consumerservicerefurbish.com>

Click on: **Download Owners Manual**
On **Manufacturer or Brand**, select: **VIZIO**
On **Product Type**, select: **TV**
On **Model Number**, select: **P65Q9-J01 & P75Q9-J01**.

What's Inside the Box

Smart TV | Power Cable | Remote | TV Feet with Screws | Cable Management Clips

1 Stand Setup

Place TV on a padded, flat surface that is larger than the TV, before installing feet or wallmount (not included).

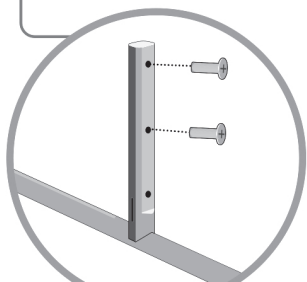
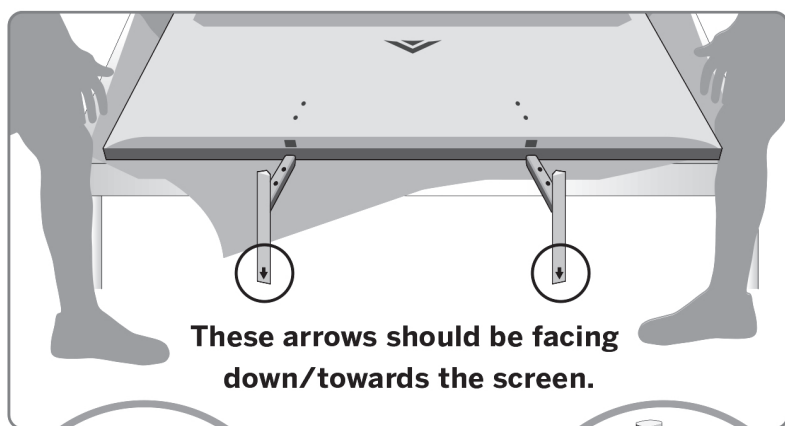

Use top two holes:

taller TV height

(Creates additional space for sound bars placed in front of TV.)

OR

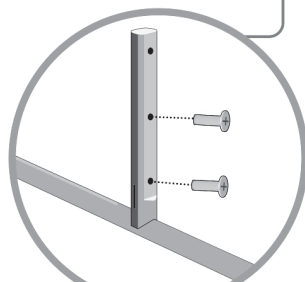

Use bottom two holes:

shorter TV height

Note: The image shown here is for illustrative purposes only and may be subject to change. The actual number of ports and their locations may vary depending on the model.

3 Remote Control

Insert Batteries

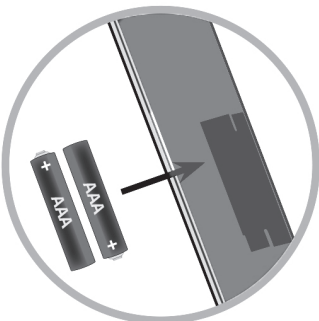

(Batteries not supplied)

Power On

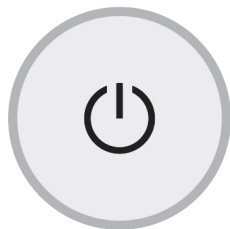

Accessibility Features

CC

Press the **CC** button to enable/disable **closed captions**. Hold down for 5 seconds to access the Accessibility Menu with features like **Talk Back** and **Zoom Mode**.

The remote control may vary depending on the model: The buttons on remote control may have a different name or location than the remote control shown in this manual.

2 Connect

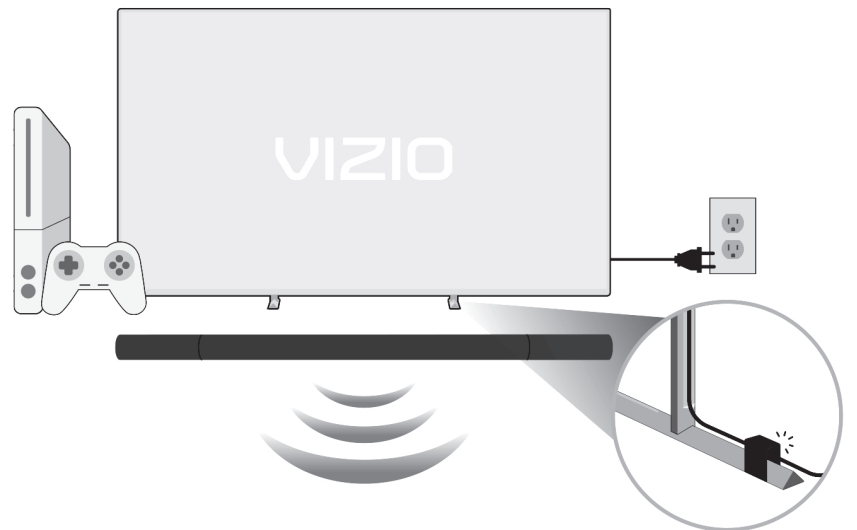

Why should I use HDMI?

Highest Quality Connection:

Connect your devices with HDMI for the best possible picture and sound.



HDMI

Dedicated Sound Bar Connection:

Connect a sound bar to the HDMI 1 (eARC) port on the TV (marked in green).



HDMI 1 (eARC)

4 Complete On-screen Instructions

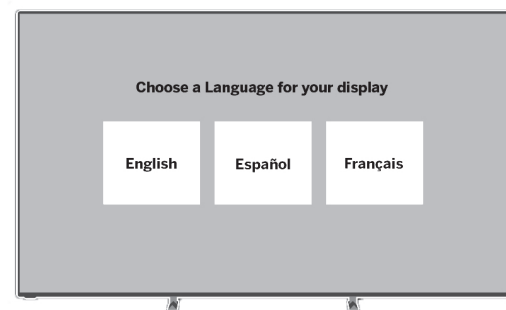

Want the best viewing experience?

Select a **Picture Mode setting** that best fits your room & lighting.

Note: The image shown here is for illustrative purposes only and may be subject to change. The actual number of ports and their locations may vary depending on the model.

The cables mentioned in this manual are not supplied with your unit.

Safety Information



When you see this symbol, please read the accompanying important warning or notice. It is intended to alert you of the presence of important operating instructions.

IMPORTANT SAFETY INSTRUCTIONS

Your Apparatus is designed and manufactured to operate within defined design limits. Misuse may result in electric shock or fire. To prevent your Apparatus from being damaged the following instructions should be observed for the installation, use, and maintenance of your Apparatus. Read the following safety instructions before operating your Apparatus. Keep these instructions in a safe place for future reference.

- To reduce the risk of electric shock or component damage, switch off the power before connecting other components to your Apparatus.
- Heed all warnings.
- Follow all instructions.
- Do not use this Apparatus near water.
- Clean only with dry cloth.
- Do not block any ventilation openings. Install in accordance with the manufacturer's instructions.
- Do not install near any heat sources such as radiators, heat registers, stoves, or other Apparatus (including amplifiers) that produce heat.
- Do not defeat the safety purpose of the polarized or grounding-type plug. A polarized plug has two blades with one wider than the other. A grounding type plug has two blades and a third grounding prong. The wide blade or the third prong are provided for your safety. If the provided plug does not fit into your outlet, consult an electrician for replacement of the obsolete outlet.
- Protect the power cord from being walked on or pinched particularly at the ends where the plug is located, near convenience receptacles, or where they exit from the Apparatus.
- Only use attachments/accessories specified by the manufacturer.
- Use only with the stand, tripod, or bracket specified by the manufacturer, or sold with the Apparatus.
- When a cart is used, use caution when moving the cart/Apparatus combination to avoid injury from tip-over.
- Unplug this Apparatus during lightning storms or when unused for long periods of time.
- Refer all servicing to qualified service personnel. Servicing is required when the Apparatus has been damaged in any way, such as power-supply cord or plug is damaged, liquid has been spilled or objects have fallen into the Apparatus, the Apparatus has been exposed to rain or moisture, does not operate normally, or has been dropped.
- Unplug the power cord before cleaning your Apparatus.
- When moving your Apparatus from an area of low temperature to an area of high temperature, condensation may form in the Apparatus housing. Wait before turning on your Apparatus to avoid causing fire, electric shock, or component damage.
- A distance of at least three feet should be maintained between your Apparatus and any heat source, such as a radiator, heater, oven, amplifier, direct sunlight, fire, etc. Do not install your Apparatus close to smoke. Operating your Apparatus close to smoke or moisture may cause fire or electric shock.
- Slots and openings in the back and bottom of the Apparatus are provided for ventilation. To ensure reliable operation of your Apparatus and to protect it from overheating, be sure these openings are not blocked or covered. Do not place your Apparatus in a bookcase or cabinet unless proper ventilation is provided.
- Never push any object into the slots and openings on your Apparatus. Do not place any objects on the top of your Apparatus. Doing so could short circuit parts causing a fire or electric shock. Never spill liquids on your Apparatus.
- Your Apparatus should be operated only from the type of power source indicated on the label. If you are not sure of the type of power supplied to your home, consult your retailer or local power company.
- Do not apply pressure or throw objects at your Apparatus. This may compromise the integrity of the Apparatus. The manufacturer's warranty does not cover user abuse or improper installations.
- The power cord must be replaced when using different voltage than the voltage specified. For more information, contact your retailer.
- When connected to a power outlet, power is always flowing into your Apparatus. To totally disconnect power, unplug the power cord.
- Do not overload power strips and extension cords. Overloading can result in fire or electric shock.
- Use only with the UL-listed wall mount bracket rate for the weight/load of the Apparatus.
- The wall socket should be installed near your Apparatus and easily accessible.
- Only power of the marked voltage can be used for your Apparatus. Any other voltage than the specified voltage may cause fire or electric shock.
- Do not attempt to repair or service your Apparatus yourself. Opening or removing the back cover may expose you to high voltages, electric shock, and other hazards.
- WARNING:** Keep your Apparatus away from moisture. Do not expose your Apparatus to rain or moisture. If water penetrates into your Apparatus, unplug the power cord and contact your retailer. Continuous use in this case may result in fire or electric shock.
- Do not use your Apparatus if any abnormality occurs. If any smoke or odor becomes apparent, unplug the power cord and contact your retailer immediately. Do not try to repair your Apparatus yourself.
- Avoid using dropped or damaged appliances. If your Apparatus is dropped and the housing is damaged, the internal components may function abnormally. Unplug the power cord immediately and contact your retailer for repair. Continued use of your Apparatus in this state may cause fire or electric shock.
- Do not install your Apparatus in an area with heavy dust or high humidity. Operating your Apparatus in environments with heavy dust or high humidity may cause fire or electric shock.
- Follow instructions for moving your Apparatus. Ensure that the power cord and any other cables are unplugged before moving your Apparatus.
- When unplugging your Apparatus, grab the head of the power plug, not the cord. Pulling on the power cord may damage the wires inside the cord and cause fire or electric shock.
- To reduce risk of electric shock, do not touch the connector with wet hands.
- Insert batteries in accordance with instructions. Incorrect polarities may cause the batteries to leak which can damage the remote control or injure the operator. Do not expose batteries to excessive heat such as sunshine, fire or the like.
- If any of the following occurs, contact a service center.**
 - The power cord fails or frays.
 - Liquid sprays or any object drops into your Apparatus.
 - Your Apparatus is exposed to rain or other moisture.
 - Your Apparatus is dropped or damaged in any way.
 - The performance of your Apparatus changes substantially.
- Do not expose Apparatus to dripping or splashing.
- Do not place objects filled with liquid, such as vases, on the Apparatus.
- If the main wall plug or the appliance coupler is disconnected, the disconnected device will remain readily operable upon reconnection to an appropriate power source.
- CAUTION** - These servicing instructions are for use by qualified service personnel only. To reduce the risk of electric shock, do not perform any servicing other than that contained in the operating instructions unless you are qualified to do so.
- The lightning flash with arrowhead symbol within an equilateral triangle is intended to alert the user to the presence of uninsulated DANGEROUS VOLTAGE within the product's enclosure that may be of sufficient magnitude to constitute a risk of electrical shock to persons.
- Please use caution around the Apparatus: pulling or pushing on the Apparatus may cause the Apparatus to tip or fall over resulting in personal injury and/or property damage.
- WARNING:** Exposure to loud sounds can damage your hearing causing hearing loss and tinnitus (ringing or buzzing in the ears). With continued exposure to loud noises, ears may become accustomed to the sound level, which may result in permanent damage to hearing without any noticeable discomfort.
- Install the Apparatus where it cannot be pulled, pushed or knocked over.
- Do not allow children to hang onto the product.
- Store the accessories (remote, batteries, etc.) in a location safely out of the reach of children.
- The American Academy of Pediatrics discourages television viewing for children younger than two years of age.
- WARNING - Stability Hazard:** A television set may fall, causing serious personal injury or death. Many injuries, particularly to children, can be avoided by taking simple precautions such as:
 - ALWAYS use cabinets or stands or mounting methods recommended by the manufacturer of the television set.
 - ALWAYS use furniture that can safely support the television set.
 - ALWAYS ensure the television set is not overhanging the edge of the supporting furniture.
 - ALWAYS educate children about the dangers of climbing on furniture to reach the television set or its controls.
 - ALWAYS route cords and cables connected to your television so they cannot be tripped over, pulled or grabbed.
 - NEVER place a television set in an unstable location.
 - NEVER place the television set on tall furniture (for example, cupboards or bookcases) without anchoring both the furniture and the television set to a suitable support.
 - NEVER place the television set on cloth or other materials that may be located between the television set and supporting furniture.
 - NEVER place items that might tempt children to climb, such as toys and remote controls, on the top of the television or furniture on which the television is placed.
 - If the existing television set is going to be retained and relocated, the same considerations as above should be applied.
- Disposal of a battery into fire or a hot oven, or mechanically crushing or cutting of a battery can result in an explosion.
- Leaving a battery in an extremely high temperature can result in an explosion or the leakage of flammable liquid or gas.
- A battery subjected to extremely low air pressure may result in an explosion or the leakage of flammable liquid or gas.

- WARNING:** To prevent injury, this Apparatus must be securely attached to the furniture/wall in accordance with the installation instructions.
- Always use a power outlet that is properly grounded.

Regulatory Information

FCC Class B Radio Interference Statement

NOTE: This equipment has been tested and found to comply with the limits for a Class B digital device, pursuant to Part 15 of the FCC Rules. These limits are designed to provide reasonable protection against harmful interference in a residential installation. This equipment generates, uses and can radiate radio frequency energy, and if not installed and used in accordance with the instructions, may cause harmful interference to radio communications. However, there is no guarantee that interference will not occur in a particular installation. If this equipment does cause harmful interference to radio or television reception, which can be determined by turning the equipment off and on, the user is encouraged to try to correct the interference by one or more of the following measures:

- Reorient or relocate the receiving antenna.
- Increase the separation between the equipment and receiver.
- Connect the equipment into an outlet on a circuit different from that to which the receiver is connected.
- Consult the dealer or an experienced radio/Television technician for help.

This device complies with Part 15 of the FCC Rules. Operation is subject to the following two conditions: (1) this device may not cause harmful interference, and (2) this device must accept any interference received, including interference that may cause undesired operation.

Notice

The changes or modifications not expressly approved by the party responsible for compliance could void the user's authority to operate the equipment. Shielded interface cables and AC power cord, if any, must be used in order to comply with the emission limits. The manufacturer is not responsible for any radio or Television interference caused by unauthorized modification to this equipment. It is the responsibilities of the user to correct such interference.

FCC Caution: Any changes or modifications not expressly approved by the party responsible for compliance could void the user's authority to operate this equipment.

FCC Radiation Exposure Statement

This equipment complies with FCC radiation exposure limits set forth for an uncontrolled environment. This equipment should be installed and operated with a minimum distance of 20 cm between the radiator and your body.

Legal Information

Software Licenses and Privacy Terms

All software is provided subject to a software license agreement(s) and you agree that you will be bound by such license agreement(s) in addition to these terms. Visit <http://www.vizio.com/terms> to learn more. Your use of this product is subject to VIZIO's privacy policy, which may be updated from time to time, and is available to view at <http://www.vizio.com/privacy>.

Export Regulations

Customer acknowledges that the VIZIO products, which include technology and software, are subject to customs and export control laws in the United States ("US"). The products may also be subject to the customs and export control laws and regulations of the country in which the products are manufactured and/or received.

The applications and content of the applications pictured herein or described in accompanying documentation may only be available in certain countries or languages, may require additional fees or subscription charges, and may be subject to future updates, modifications or discontinuation without notice. VIZIO has no control over third party applications or content and assumes no responsibility for the availability or interruption of such applications or content. Additional third party terms, conditions and restrictions apply.

Information in document is subject to change without notice. To review the most updated version of this document and the associated User Manual, go to www.vizio.com.

© 2021 VIZIO, Inc. All Right Reserved.

This document may not be copied in whole or in part without the written permission of VIZIO, Inc. VIZIO, Inc. has made reasonable efforts to ensure the accuracy of the information provided herein. All product specifications, functionality, features, configurations, performance, design and other product information described herein are subject to change without notice. VIZIO, Inc. is not responsible for typographical, technical, or descriptive errors.

VIZIO, the VIZIO logo, the V logo, VIZIO SmartCast, and other terms and phrases are trademarks or registered trademarks of VIZIO, Inc.

Your VIZIO product will include one or more listed technologies. Please refer to the user manual to determine which technology is applicable to your product.



The terms HDMI, HDMI High-Definition Multimedia Interface, and the HDMI Logo are trademarks or registered trademarks of HDMI Licensing Administrator, Inc.



Dolby, Dolby Vision, Dolby Audio, and the double-D symbol are trademarks of Dolby Laboratories Licensing Corporation. Manufactured under license from Dolby Laboratories. Confidential unpublished works. Copyright © 1992-2021 Dolby Laboratories. All rights reserved.



For DTS patents, see <http://patents.dts.com>. Manufactured under license from DTS, Inc. DTS, DTS:X, VirtualX, DTS-HD, the DTS:X logo, and the DTS-HD logo are registered trademarks or trademarks of DTS, Inc. in the United States and other countries. © 2020 DTS, Inc. ALL RIGHTS RESERVED.

Google Play Logo, YouTube, and Chromecast built-in are trademarks of Google LLC.

This VIZIO TV is compatible with AirPlay 2 and HomeKit. iOS 12.3 or later or macOS 10.14.5 or later is required. Apple and AirPlay 2 are trademarks of Apple Inc., registered in the U.S. and other countries. HomeKit is a trademark of Apple Inc.

Other names of companies, products, and services used may be trademarks, trade names or service marks of others and VIZIO, Inc. disclaims any interest in trademarks, trade names or service marks other than its own. Mention of non-VIZIO products is for informational purposes only.

Battery Disposal

Caution: This product may be shipped with batteries. Do not dispose of batteries in a fire or with ordinary household waste. Batteries may explode and can cause damage. Replace batteries only with the same or equivalent type of battery recommended by VIZIO. The disposal of batteries may be regulated by your state. For more information on recycling or properly disposing of your batteries, please check with your state or go to www.vizio.com/environment.

Product Recycling

The disposal and recycling of consumer electronic products may be regulated by your state. Always properly dispose of your VIZIO products in accordance with local laws and regulations. VIZIO supports the proper recycling of our products. For information on how to properly recycle your VIZIO products and to learn more about consumer electronics recycling laws, please go to www.vizio.com/environment or call (800) 374-3473.

Packaging Disposal

VIZIO encourages the recycling of the packaging used for this product. Please break-down all boxes and recycle eligible materials according to local laws and regulations. For more information please go to www.vizio.com/environment or call (800) 374-3473.

REFURBISHED PRODUCT LIMITED NINETY DAYS WARRANTY

The *Refurbished Product Service Center* offers the following WARRANTY to the ORIGINAL purchaser of a product which we have refurbished.

This product that has been refurbished is warranted against any electronic or mechanical defects for a period of NINETY DAYS from the date of the original purchase by the consumer. Since this unit was sold as a refurbished item, the warranty does not apply to any cosmetic appearance items such as scratches. Should a defect occur, the *Refurbished Product Service Center* will repair or, at its option, replace defective unit/parts with new or rebuilt materials without charge for either parts or labor. Replacement unit/parts will be warranted for the remaining portion of the original warranty period.

This warranty does not cover installation or damage from accident, misuse, abuse, improper wiring, incorrect voltage, operating the unit against the instructions in the owner's manual or any product which has been opened, altered, or tampered with.

This warranty does not cover costs for removal and or installation of the unit for repair. Under no circumstances shall the service center be liable for any special, incidental or consequential damages or for any other expenses incurred by reason of use or sale of this product. This warranty is in lieu of any other warranties expressed or implied warranty of merchantability of fitness for particular use or otherwise.

This warranty gives the consumer specific legal rights and they may also have other rights which vary from State to State. Some States do not follow the exclusion or limitation of incidental or consequential damages, hence the above exclusion and limitations may not apply.

Refurbished Product Service Center
13225 Marquardt Avenue Santa Fe Springs, CA 90670.

WARRANTY REPAIR INFORMATION

If you need service on your unit and this product requires repair during the 90 days warranty period; please go to www.ConsumerServiceRefurbish.com or call the *Refurbished Product Service Center* at 562-946-3531 to obtain the required return authorization (RA) number. Pack the unit properly (the original carton is ideal for this purpose) along with a copy of your purchase receipt and a letter describing the problem. Send the unit freight prepaid and insured to:

Refurbished Product Service Center,
Att: Customer Service Department 13225 Marquardt Avenue Santa Fe Springs, CA 90670

Your unit will be promptly repaired and returned to you.

We will refuse to accept delivery of the returned unit unless the assigned RA number appears on the outside of the shipping carton.

Owner's Information (Keep for your permanent records)

NAME: _____

ADDRESS: _____

CITY: _____ STATE: _____ ZIP CODE: _____

PHONE: _____ E-MAIL: _____

MODEL: _____ SERIAL NO.: _____

805008809



Printed in Mexico / Sc: 07.07.2022 / TAB
Obpn:X41G78SV997A64
Shmndl: P65Q9J01_B / ELBRD: J.E.