

Shark IQ 2-in-1 ROBOT Floor Cleaner

2400WD Series WARNINGS AND WARRANTIES



814100052

IMPORTANT SAFETY INSTRUCTIONS

PLEASE READ CAREFULLY BEFORE USE • FOR HOUSEHOLD USE ONLY

If the charging cable plug does not fit fully into the outlet, reverse the plug. If it still does not fit, contact a qualified electrician. DO NOT force into outlet or try to modify to fit.

WARNING

To reduce the risk of fire, electric shock, injury, or property damage:

GENERAL WARNINGS

When using an electrical appliance, basic precautions should always be followed, including the following:

1. This appliance consists of a Robot Floor Cleaner and charging dock with power supply. These components contain electrical connections, electrical wiring, and moving parts that potentially present risk to the user.
2. Before each use, carefully inspect all parts for any damage. If a part is damaged, discontinue use.
3. This Robot Floor Cleaner contains no serviceable parts.
4. **DO NOT** use Robot Floor Cleaner for any purpose other than those described in the Owner's Guide.
5. With exception of the filters, dust bin, fluid reservoir, and pads, **DO NOT** expose any parts of the Robot Floor Cleaner to water or other liquids.

USE WARNINGS

6. This appliance can be used by persons with reduced physical, sensory, or mental capabilities or lack of experience and knowledge if they have been given supervision or instruction concerning use of the appliance in a safe way and understand the hazards involved.
 - a) Children shall not play with the appliance.
 - b) Cleaning and user maintenance shall not be made by children without supervision.
7. Always turn off the Robot Floor Cleaner before inserting or removing the filter, dust bin, or side brushes.
8. **DO NOT** handle plug, charging dock, charging cable, or Robot Floor Cleaner with wet hands. Cleaning and user maintenance shall not be made by children without supervision.
9. **DO NOT** use the Robot Floor Cleaner without the dust bin, filter, brushroll, and side brush in place.
10. **DO NOT** damage the charging cord:
 - a) **DO NOT** pull or carry charging dock by the cord or use the cord as a handle.
 - b) **DO NOT** unplug by pulling on cord. Grasp the plug, not the cord.
 - c) **DO NOT** close a door on the cord, pull the cord around sharp corners, or leave the cord near heated surfaces.
11. **DO NOT** put any objects into nozzle or accessory openings. **DO NOT** use with any opening blocked; keep free of dust, lint, hair, and anything that may reduce airflow.
12. **DO NOT** use Robot Floor Cleaner if airflow is restricted. If the air paths become blocked, turn the vacuum cleaner off and remove all obstructions before turning on the unit again.
13. Keep all vacuum openings away from hair, face, fingers, uncovered feet, or loose clothing.
14. **DO NOT** use if Robot Floor Cleaner is not working as it should, or has been dropped, damaged, left outdoors, or dropped into water.
15. **DO NOT** place Robot Floor Cleaner on unstable surfaces.
16. If the Robot Floor Cleaner is not starting from the dock, it must be placed at least 1.5 feet (45 cm) away from any stairs or ledges.

17. **DO NOT** use to pick up:
 - a) Liquid spills.
 - b) Large objects.
 - c) Hard or sharp objects (glass, nails, screws, or coins).
 - d) Large quantities of dust (drywall dust, fireplace ash, or embers).
 - e) Smoking or burning objects (hot coals, cigarette butts, or matches).
 - f) Flammable or combustible materials (lighter fluid, gasoline, or kerosene).
 - g) Toxic materials (high concentrations of chlorine bleach liquid, high concentrations of ammonia, or drain cleaning solution.)
18. **DO NOT** use in the following areas:
 - a) Outdoor areas near fireplaces with unobstructed entrances.
 - b) Spaces that are enclosed and may contain explosive or toxic fumes or vapors (lighter fluid, gasoline, kerosene, paint, paint thinners, mothproofing substances, or flammable dust).
 - c) In an area with a space heater.
 - d) Near fireplaces with unobstructed entrances.
19. Turn **OFF** the Robot Floor Cleaner before any adjustment, cleaning, maintenance, or troubleshooting.
20. Allow all filters to air-dry completely before reinstalling them in the Robot Floor Cleaner to prevent liquid from being drawn into electric parts.
21. **DO NOT** modify or attempt to repair the Robot Floor Cleaner or the battery yourself, except as indicated in the Owner's Guide. **DO NOT** use the vacuum if it has been modified or damaged.
22. Remove all spilled or leaked liquid from the dock landing mat, base, or floor, as it could lead to risk of electrical shock.
23. Try a little of the VACMOP™ cleaning solution on a small, inconspicuous area of the floor to ensure the solution doesn't damage the floor.
24. When refilling the reservoir, check for leaks, as pooled liquids id a slipping hazard and may cause electrical shock. If the reservoir is damaged, it must be replaced.
25. Use caution walking on mopped floors, as they may be slippery while damp.
26. For your Robot Floor Cleaner's cliff sensors to work properly, all runners, rugs, carpets, or small thresholds (like child gates) must be 8 inches from any stairs (or must be continuous and extend over the edge of the stairs). If a runner, rug, carpet, or small threshold that is less than 8 inches from the stairs cannot be moved, you must use a no-go zone to block off the stairs.
27. **DO NOT** use as an attachment to power tools for dust collection.
28. Place the cords from other appliances out of the area to be cleaned.
29. **DO NOT** operate the vacuum in a room where an infant or child is sleeping.
30. **DO NOT** operate the vacuum in an area where there are lit candles or fragile objects on the floor to be cleaned.
31. **DO NOT** operate the vacuum in a room that has lit candles on furniture that the vacuum may accidentally hit or bump into.
32. **DO NOT** allow children to sit on the vacuum.

BATTERY USE

33. The battery is the power source for the vacuum. Carefully read and follow all charging instructions.
 34. To prevent unintentional starting, ensure the vacuum is powered off before picking it up or carrying it.
 35. Use **ONLY** the Shark® charging dock XDRV2600WD and use only battery RVB850A. Use of batteries or battery chargers other than those indicated may create a risk of fire.
 36. Keep the battery away from all metal objects such as paper clips, coins, keys, nails, or screws. Shorting the battery terminals together increases the risk of fire or burns.
 37. Under abusive conditions, liquid may be ejected from the battery. Avoid contact with this liquid, as it may cause irritation or burns. If contact occurs, flush with water. If liquid contacts eyes, seek medical help.
 38. Robot Floor Cleaner should not be stored, charged, or used at temperatures below 50°F (10°C) or above 104°F (40°C). Ensure the battery and vacuum have reached room temperature before charging or use. Exposing the robot or battery to temperatures outside of this range may damage the battery and increase the risk of fire.
 39. **DO NOT** expose the Robot Floor Cleaner or battery to fire or temperatures above 265°F (130°C) as it may cause explosion.
 40. Non-rechargeable batteries cannot be recharged.
- ### NO-GO ZONES
41. Always use no-go zones around reflective flooring and surfaces.
 42. No-go zones should always be used near carpeted stairs.
 43. **DO NOT** use no-go zones within 10 feet of the dock.
- ### LASER WARNING
44. This product has a Class 1 laser. It is safe under reasonably foreseeable conditions (as defined in the Owner's Guide). Always turn off the power before lifting the Robot Floor Cleaner or performing any maintenance on it.
 45. **DO NOT** look directly into laser.

SAVE THESE INSTRUCTIONS

DOCK SETUP

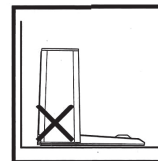
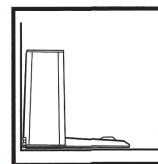
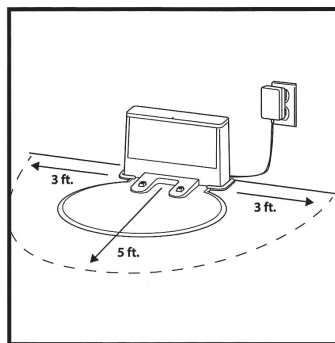

- Select a permanent location with strong Wi-Fi for the **Charging Dock**, because every time you relocate it, your robot will have to completely re-map your house.
- Place the dock with its back against a wall and attach the landing mat. Select a level surface on bare floor, in a central area. Do not place dock against baseboards or heating elements.
- Remove any objects that are closer than 3 feet from either side of the dock, or closer than 5 feet from the front of the dock.
- Plug in the dock. The indicator light will illuminate green when the dock has power.

INSTALLING THE SIDE BRUSH

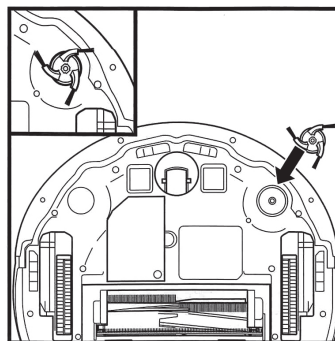

Snap the included **Side Brush** onto the square peg on the bottom of the robot.

NOTE: Side brush design may vary.

NOTE: Accessories may vary depending on the model.

The images shown here are for illustrative purposes only and may be subject to change.

CHARGING

IMPORTANT: The SHARK® IQ 2-IN-1 ROBOT has a pre-installed rechargeable battery. Charge the battery completely before first use. It may take up to 6 hours to fully charge.

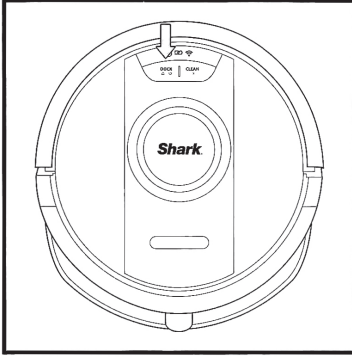

To turn **ON** the robot, press and hold the DOCK button for 5-7 seconds. To **charge**, place the robot on the dock. The robot will beep when charging begins and the charging indicator on the dock will turn from green to blue.

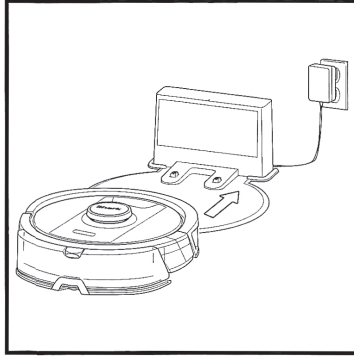

When the cleaning cycle is complete, or if the battery is running low, the robot will search for the dock. If the robot doesn't return to dock, its charge may have run out, or if it is in wet cleaning mode, the dock may be blocked by carpet.

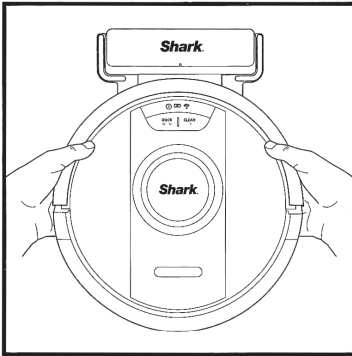

If the robot has no charge or it cannot return to the dock, manually place it on the dock. The indicator light will turn blue and the robot will beep when it is correctly placed on the dock.

NOTE: When manually placing the robot on the dock, make sure the **Charging Contacts** on the bottom of the robot are touching the ones on the dock. While the robot is charging, both white LED lights will flash. When charging is complete, both white lights will illuminate steadily.

NOTE: When picking up the robot, be careful not to place fingers between the bumper and the base of the robot.



FCC WARNING

This equipment has been tested and found to comply with the limits for a Class B digital device, pursuant to parts 15 of the FCC Rules. These limits are designed to provide reasonable protection against harmful interference in a residential installation. This equipment generates, uses, and can radiate radio frequency energy and, if not installed and accordance with the instructions, may cause harmful interference to radio communications. However, there is no guarantee that interference will not occur in a particular installation. If this equipment does cause harmful interference to radio or television reception, which can be determined by turning the equipment off and on, the user is encouraged to try to correct the interference by one or more of the following measures:

- Reorient or relocate the receiving antenna.
- Increase the separation between the equipment and receiver.
- Connect the equipment into an outlet on a circuit different from that to which the receiver is connected.
- Consult the dealer or an experienced radio/TV technician for help.

This Device complies with part 15 of the FCC rules. Operation is subject to the following conditions:

- 1 This device may not cause harmful interference
 - 2 This device must accept any interference received, including interference that may cause undesired operation.
- Changes or modifications not expressly approved by the party responsible for compliance could void the user's authority to operate this device.



BATTERY REMOVAL AND DISPOSAL

This product uses a battery. When the battery no longer holds a charge, it should be removed from the vacuum and recycled. **DO NOT** incinerate or compost the battery.

When your lithium-ion battery needs to be replaced, dispose of it or recycle it in accordance with local ordinances or regulations. In some areas, it is illegal to place spent lithium-ion batteries in the trash or in a municipal solid waste stream. Return spent battery to an authorized recycling center or to retailer for recycling. Contact your local recycling center for information on where to drop off the spent battery.

For more information on battery removal for disposal, please visit sharkclean.com/batterysupport.

The RBRC™ (Rechargeable Battery Recycling Corporation) seal on the lithium-ion battery indicates that the costs to recycle the battery at the end of its useful life have already been paid by SharkNinja. In some areas, it is illegal to place spent lithium-ion batteries in the trash or municipal solid waste stream and the RBRC program provides an environmentally conscious alternative.

RBRC, in cooperation with SharkNinja and other battery users, has established programs in the United States and Canada to facilitate the collection of spent lithium-ion batteries. Help protect our environment and conserve natural resources by returning the spent lithium-ion battery to an authorized SharkNinja service center or to your local retailer for recycling. You may also contact your local recycling center for information on where to drop off the spent battery, or call 1-800-798-7398.

SharkNinja Operating LLC

Illustrations may differ from actual product. We are constantly striving to improve our products; therefore the specifications contained herein are subject to change without notice.

This product may be covered by one or more U.S. patents.

REFURBISHED PRODUCT LIMITED NINETY DAYS WARRANTY

The **Refurbished Product Service Center** offers the following **WARRANTY** to the ORIGINAL purchaser of a product which we have refurbished.

This product that has been refurbished is warranted against any electronic or mechanical defects for a period of **NINETY DAYS** from the date of the original purchase by the consumer. Since this unit was sold as a refurbished item, the warranty does not apply to any cosmetic appearance items such as scratches. Should a defect occur, the **Refurbished Product Service Center** will repair or, at its option, replace defective unit/parts with new or rebuilt materials without charge for either parts or labor. Replacement unit/parts will be warranted for the remaining portion of the original warranty period.

This warranty does not cover installation or damage from accident, misuse, abuse, improper wiring, incorrect voltage, operating the unit against the instructions in the owner's manual or any product which has been opened, altered, or tampered with.

This warranty does not cover costs for removal and or installation of the unit for repair. Under no circumstances shall the service center be liable for any special, incidental or consequential damages or for any other expenses incurred by reason of use or sale of this product. This warranty is in lieu of any other warranties expressed or implied warranty of merchantability of fitness for particular use or otherwise.

This warranty gives the consumer specific legal rights and they may also have other rights which vary from State to State. Some States do not follow the exclusion or limitation of incidental or consequential damages, hence the above exclusion and limitations may not apply.

Refurbished Product Service Center
13225 Marquardt Avenue Santa Fe Springs, CA 90670.

WARRANTY REPAIR INFORMATION

If you need service on your unit and this product requires repair during the 90 days warranty period; please go to www.ConsumerServiceRefurbish.com or call the **Refurbished Product Service Center** at 562-946-3531 to obtain the required return authorization (RA) number. Pack the unit properly (the original carton is ideal for this purpose) along with a copy of your purchase receipt and a letter describing the problem. Send the unit freight prepaid and insured to:

Refurbished Product Service Center,
Att: Customer Service Department 13225 Marquardt Avenue Santa Fe Springs, CA 90670

Your unit will be promptly repaired and returned to you. We will refuse to accept delivery of the returned unit unless the assigned RA number appears on the outside of the shipping carton.

Owner's Information
(Keep for your permanent records)

NAME: _____

ADDRESS: _____

CITY: _____

STATE: _____

ZIP CODE: _____

PHONE: _____

E-MAIL: _____

MODEL: _____

SERIAL NO.: _____

