

# Shark

8 1 4 1 0 0 1 5 7

## Navigator® Lift-Away® Pet with PowerFins® HairPro™ and Self-Cleaning Brushroll Upright Vacuum

### IMPORTANT SAFETY INSTRUCTIONS FOR HOUSEHOLD USE ONLY

#### ⚠ WARNING

To reduce the risk of fire, electric shock, injury, or property damage, when using an electrical appliance, basic precautions should always be followed, including the following:

#### READ ALL INSTRUCTIONS BEFORE USING THIS VACUUM

1. Inspect power cord and plug for any damage before use. **DO NOT** use vacuum cleaner with a damaged cord or plug. Turn off all controls before plugging in or unplugging the vacuum cleaner. Store your vacuum cleaner with the power cord secured around the two cord hooks. To minimize the risk of power cord damage, do not allow the motorized brush roll to ingest the cord. If this occurs, immediately shut off power to the vacuum and remove the cord.
2. This appliance has a polarized plug, if the plug does not fit fully into the outlet, reverse the plug (one blade is wider than the other). If it still does not fit, contact a qualified electrician. **DO NOT** force into outlet or try to modify to fit.
3. Your vacuum cleaner may consist of a motorized nozzle, wand, hose, and/or vacuum pod. This device contains electrical connections, electrical wiring, and moving parts that potentially present risk to the user.
4. Use only identical replacement parts.
5. Carefully observe and follow the instructions provided below to avoid improper use of the appliance. **DO NOT** use the vacuum for any purpose other than those described in this manual.
6. Before use, carefully inspect all parts for any damage. **DO NOT** use if any parts are damaged.
7. The use of an extension cord is **NOT** recommended.
8. This vacuum cleaner contains no serviceable parts.
9. This appliance can be used by persons with reduced physical, sensory or mental capabilities or lack of experience and knowledge if they have been given supervision or instruction concerning use of the appliance in a safe way and understand the hazards involved. Cleaning and user maintenance shall not be made by children. Keep the appliance and its cord out of reach of children. **DO NOT** allow the appliance to be used by children. **DO NOT** allow to be used as a toy. Close supervision is necessary when used near children.
10. Always turn off the vacuum cleaner before connecting or disconnecting any motorized nozzles or other accessories.
11. **DO NOT** handle plug or vacuum cleaner with wet hands.
12. **DO NOT** use without filters in place.
13. Only use Shark® branded filters and accessories.
14. **DO NOT** damage the power cord:
  - a) **DO NOT** pull or carry vacuum cleaner by the cord or use the cord as a handle.
  - b) **DO NOT** unplug by pulling on cord. Grasp the plug, not the cord.
  - c) **DO NOT** run the vacuum cleaner over the power cord, close a door on the cord, pull the cord around sharp corners, or leave the cord near heated surfaces.
15. **DO NOT** put any objects into nozzle or accessory openings. **DO NOT** use with any opening blocked; keep free of dust, lint, hair, and anything that may reduce airflow.
16. **DO NOT** use if nozzle or accessory airflow is restricted. If the air paths or the motorized floor nozzle become blocked, turn the vacuum cleaner off and unplug from electrical outlet. Remove all obstructions before you plug in and turn on the unit again.
17. Keep nozzle and all vacuum openings away from hair, face, fingers, uncovered feet, or loose clothing.
18. **DO NOT** use if vacuum cleaner is not working as it should, or has been dropped, damaged, left outdoors, or dropped into water.
19. Use extra care when cleaning on stairs.
20. **DO NOT** leave the vacuum cleaner unattended while plugged in.
21. When powered on, keep the vacuum cleaner moving over the carpet surface at all times to avoid damaging the carpet fibers.

22. **DO NOT** place vacuum cleaner on unstable surfaces such as chairs or tables.
23. Your Shark® vacuum may not be designed to stand up on its own. When taking a break from cleaning, you may need to lean it against furniture or a wall, or lay it flat on the floor. Using the vacuum for an application where the unit lacks stability may result in personal injury.
24. **DO NOT** use to pick up:
  - a) Liquids
  - b) Large objects
  - c) Hard or sharp objects (glass, nails, screws, or coins)
  - d) Large quantities of dust (drywall dust, fireplace ash, or embers). **DO NOT** use as an attachment to power tools for dust collection.
  - e) Smoking or burning objects (hot coals, cigarette butts, or matches)
  - f) Flammable or combustible materials (lighter fluid, gasoline, or kerosene)
  - g) Toxic materials (chlorine bleach, ammonia, or drain cleaner)
25. **DO NOT** use in the following areas:
  - a) Poorly lit areas
  - b) Wet or damp surfaces
  - c) Outdoor areas
  - d) Spaces that are enclosed and may contain explosive or toxic fumes or vapors (lighter fluid, gasoline, kerosene, paint, paint thinners, mothproofing substances, or flammable dust)
26. Turn off all controls before plugging in or unplugging the vacuum.
27. Unplug from electrical outlet when not in use and before any maintenance or cleaning.
28. Hand wash with water only. Washing with cleaning chemicals could damage the unit.
29. During cleaning or routine maintenance, **DO NOT** cut anything other than hair, fibers, or string wrapped around the brushroll.
30. Allow all filters to air-dry completely before replacing in the vacuum to prevent liquid from being drawn into electric parts.
31. Make sure the dust cup and all filters are in place after routine maintenance.
32. If provided, secure the power cord around the two cord hooks during storage.

### SAVE THESE INSTRUCTIONS

#### ASSEMBLY

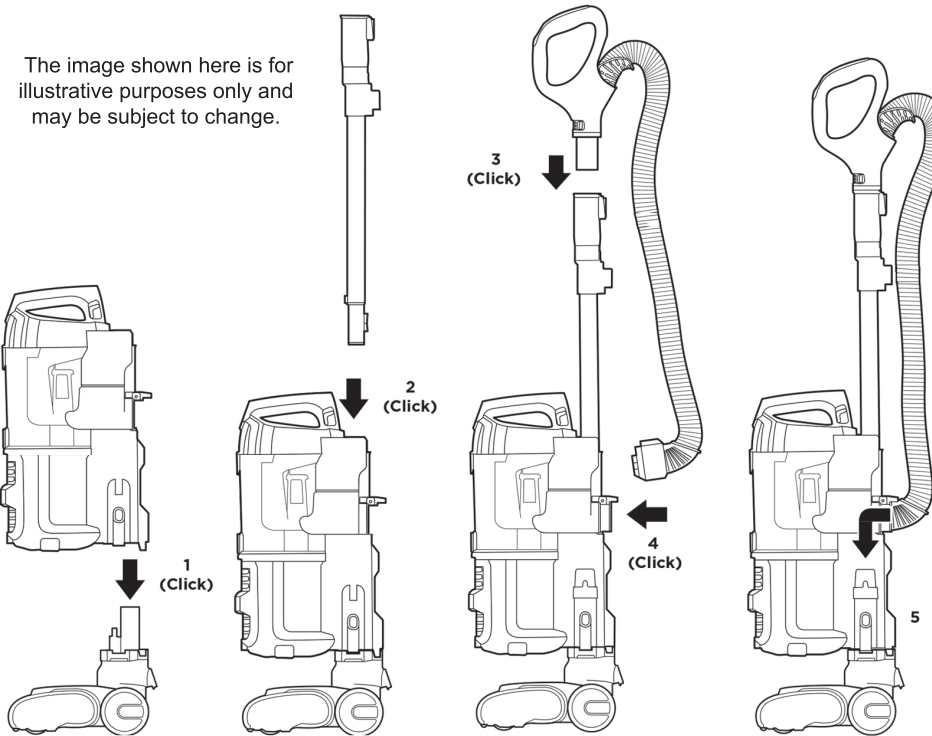

1. Place **Pod** onto **Floor Nozzle Post**.
2. Insert **Wand** into pod.
3. Insert **Handle** into wand.
4. Attach **Hose Clip** to wand.
5. Store accessories.

For proper operation, ensure all parts are firmly clicked into place.

#### WHOLE-HOME CLEANING

#### SETTINGS

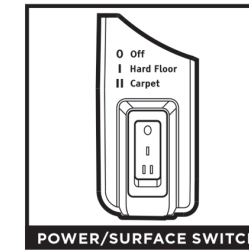

Select surface setting:

- Off**
- I Hard Floor**  
For bare floors and area rugs.
- II Carpet**  
For high pile carpets.

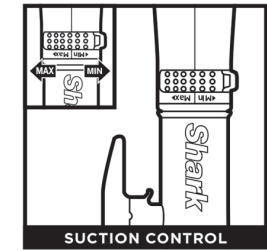

Rotate the **Suction Control Slider** on the handle to adjust the suction depending on the floor type.

- Min:** to reduce suction and increase maneuverability on carpets.
- Max:** to increase suction on bare floors.

**NOTE:** The brushroll spins in both modes.

#### BRUSHROLL INDICATOR LIGHT

#### WHAT DOES THE BRUSHROLL INDICATOR LIGHT MEAN?

**Solid Green:** The brushroll is spinning and working as intended.

**Solid Red:** There is a jam in the brushroll area. Turn off the vacuum and unplug it, then remove any blockages in the nozzle.

**Flashing Red:** The motorized floor nozzle is overheating. Turn off the vacuum, unplug it, and remove any blockages. Let the vacuum cool down for at least 60 minutes before restarting. See Troubleshooting section for more information.

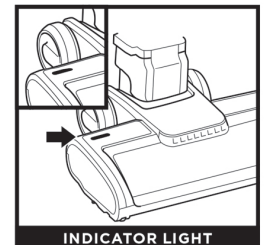

**NOTE:** For deep carpet cleaning per ASTM F608 (embedded dirt in carpets), set to **Max** suction and use setting **II, Carpet**.

#### CLEANING MODES

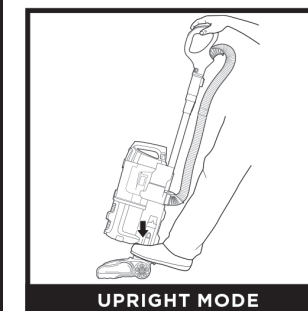

UPRIGHT MODE

To engage **Brushroll**, step on floor nozzle and tilt handle back firmly. Press the Power/Surface switch to the appropriate floor setting.

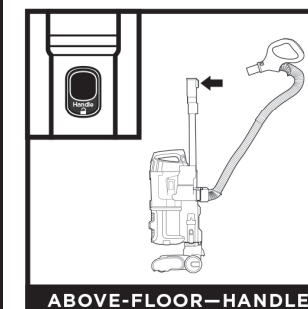

ABOVE-FLOOR—HANDLE

Press the **Handle Release** button and pull up on the handle to detach it from the wand.

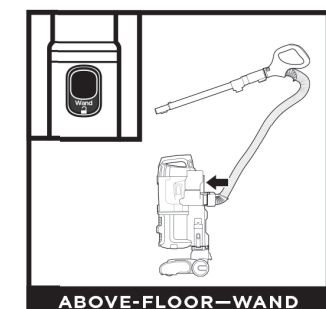

ABOVE-FLOOR—WAND

Press the **Wand Release** button and pull up on the handle to detach the wand from the pod.

In Lift-Away® mode, you can clean with the handle or the handle with the wand.

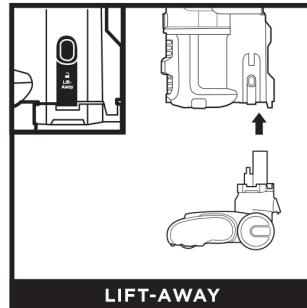

LIFT-AWAY

Press the **Lift-Away** button to detach the pod from the floor nozzle.

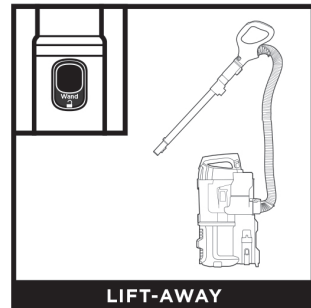

LIFT-AWAY

With pod removed, press the **Wand Release** button to detach the wand from the pod.

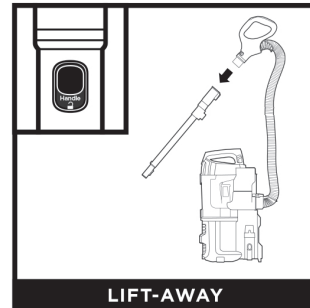

LIFT-AWAY

Press the **Handle Release** button and pull up on the handle to detach it from the wand.

**NOTE:** All accessories are compatible with both the wand and the handle.

### EMPTYING THE DUST CUP



**IMPORTANT:** Unplug the power cord before performing any maintenance. Empty the dust cup each time you vacuum and periodically during cleaning, when debris in the dust cup reaches the MAX fill line.

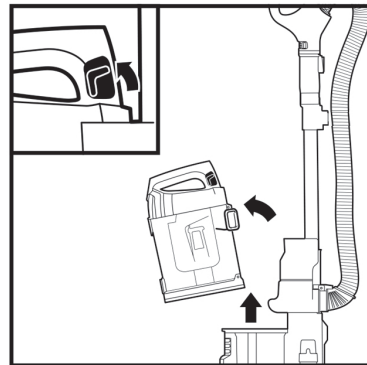

To remove **Dust Cup**, slide up tabs on both sides of dust cup handle. Tilt dust cup forward, then lift to remove.

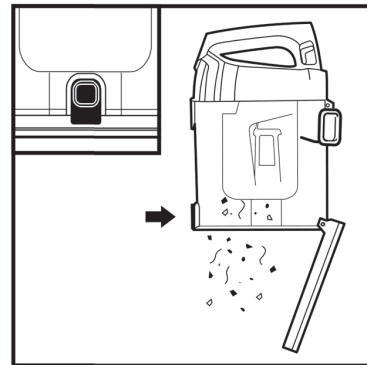

Press lower release button to open bottom of dust cup.

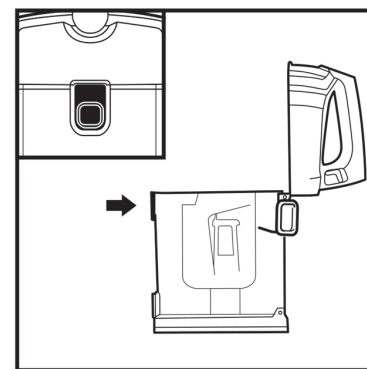

To remove collected debris from **Lint Screen**, press top release button and lift handle to open. Gently brush debris off the screen.

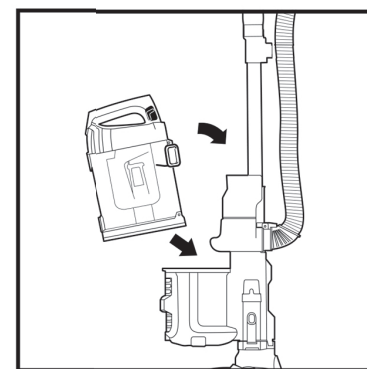

To reinstall, place bottom of dust cup into pod and then tilt until it clicks into place.

### CLEANING AND REPLACING THE FILTERS

#### CLEANING FILTERS

Regularly rinse and replace the filters to maintain your vacuum's suction power.

To prevent damage from cleaning chemicals, rinse filters with cold water only. Allow all filters to air-dry for at least 24 hours before reinstalling them to prevent liquid from being drawn into electric parts.

**IMPORTANT: DO NOT** use soap when cleaning the filters.

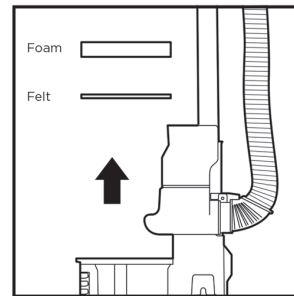

#### CLEAN PRE-MOTOR FILTERS EVERY 3 MONTHS

Remove **Dust Cup**, then lift out **Filters**.

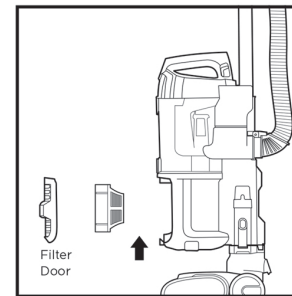

#### RINSE HEPA FILTER EVERY YEAR

Remove dust cup, tilt **Filter Door** and firmly pull it off. Press tab at top of **HEPA Filter** and pull out filter. To reinstall, insert HEPA filter into unit and replace the filter door.

### MAINTENANCE

#### NOZZLE MAINTENANCE

#### SELF-CLEANING BRUSHROLL

If any hair is wrapped around the brushroll, continue vacuuming, using setting II, Carpet mode, on a bare floor surface, a low-pile carpet, or a small area rug. This will allow the self-cleaning brushroll to remove the hair wrap and send it to the dust cup.

If you run over a hard or sharp object or notice a noise change while vacuuming, check for blockages or objects caught in the brushroll.

If some fibers remain wrapped around the brushroll after continued use, clear them from the brushroll.

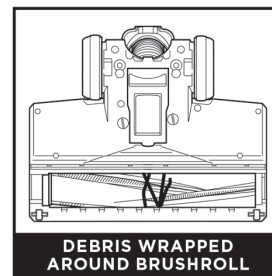

DEBRIS WRAPPED AROUND BRUSHROLL

Clean off any debris on the brushroll.

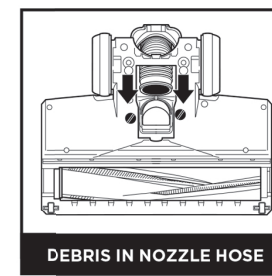

DEBRIS IN NOZZLE HOSE

To clear debris and blockages from the nozzle hose, open the locks on the bottom of the nozzle. With a coin, turn the locks counterclockwise to open, then lift the cover.

#### CORD MAINTENANCE

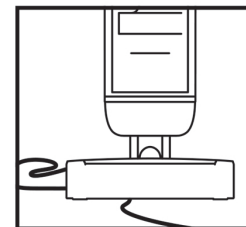

To minimize the risk of power cord damage, **DO NOT** run the vacuum over the power cord. If this occurs, immediately shut off power to the vacuum and remove the cord from the brushroll or nozzle.

#### TECHNICAL SPECIFICATIONS

Voltage: 120V~, 60Hz

### CHECKING FOR BLOCKAGES

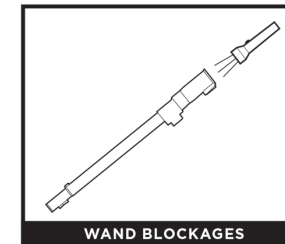

WAND BLOCKAGES

Detach wand from floor nozzle and handle, and check both ends for blockages.

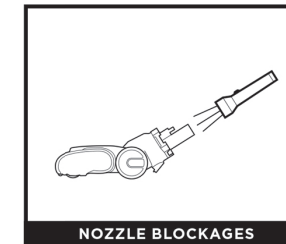

NOZZLE BLOCKAGES

Detach floor nozzle from wand and vacuum pod, tilt nozzle neck back, and check opening for blockages.

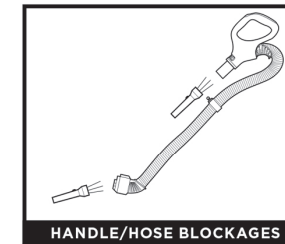

HANDLE/HOSE BLOCKAGES

Detach handle from wand and hose from the vacuum pod, and check openings for blockages.

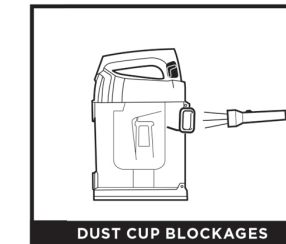

DUST CUP BLOCKAGES

Detach dust cup from vacuum pod. Empty dust cup, remove debris from lint screen, and check for blockages.

### TROUBLESHOOTING

#### Power cord caught in brushroll or floor nozzle.

- To minimize the risk of power cord damage, **DO NOT** run the vacuum over the power cord. If this occurs, immediately shut off power to the vacuum and remove the cord from the brushroll or nozzle.
- Inspect power cord and plug for any damage before use. **DO NOT** use vacuum cleaner with a damaged cord or plug. Turn off all controls before plugging in or unplugging the vacuum cleaner. Store your vacuum cleaner with the power cord secured around the two cord hooks.

#### Vacuum is not picking up debris. No suction or light suction.

- Check filters to see if they need cleaning. Follow instructions for rinsing and air-drying the filters before reinstalling them.
- Dust cup may be full; empty dust cup.
- Check hose, hose connections, nozzle, wand, pod, and accessories for blockages. Clear any blockages found. See Checking for Blockages section for more information.
- If any hair, string, or carpet fibers are wrapped around the brushroll, extend cleaning time to allow the self-cleaning brushroll to remove them. If some hair or fibers remain wrapped around brushroll after continued use, carefully remove them. See Cleaning the Brushroll section for more information.

#### Vacuum lifts area rugs.

- Make sure Power/Surface switch is set to Thick Carpet & Area Rug Cleaning.
- Suction is powerful. Take care when vacuuming area rugs or rugs with delicately sewn edges.

#### Brushrolls do not spin.

- If the Brushroll Indicator Light turns red, immediately turn off and unplug the vacuum. Remove pod and wand from floor nozzle and clear any blockages. Reconnect nozzle, plug in vacuum, and turn on power.
- With the power on, recline the handle, which will automatically turn on the brushrolls.

#### Vacuum turns off on its own or indicator light flashes red.

If your vacuum overheats, the thermostat will automatically turn off the motor. Perform the following steps to restart:

- Turn vacuum off and unplug it.
- Empty dust cup and clean filters. See Emptying the Dust Cup and Cleaning the Filters section for more information.
- Check for blockages in hose, wand, floor nozzle, accessories, and inlet openings.
- Allow unit to cool for a minimum of 60 minutes.
- Plug in vacuum and turn it on.

For all other issues, please contact a service center

8 1 4 1 0 0 1 5 7



PRINTED IN MEXICO SC: 11-27-2023  
OBPN: ZD201\_IB\_E\_MP\_Mv3\_221215  
SHNMDL: ZD201\_B / TAB / Elbrd:J.E.

# QUICK START GUIDE

Please be sure to read the enclosed Shark® Owner's Guide prior to using your unit.

## WHAT'S INSIDE

- (A) Handle & Hose
- (B) Wand
- (C) Vacuum Pod
- (D) Floor Nozzle
- (E) Crevice Tool
- (F) Upholstery Tool

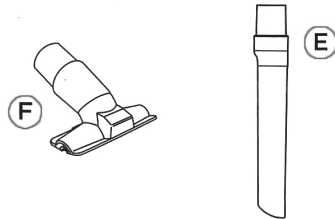

## HELPFUL TIPS

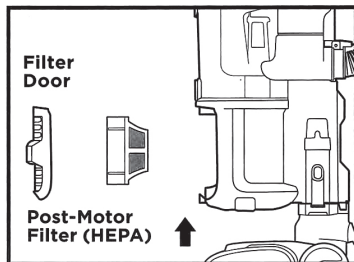
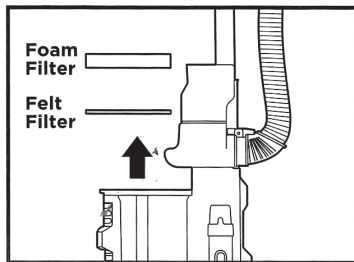

Accessory type and quantity may vary depending on the model.

## ASSEMBLY

1. Place **Pod** onto **Floor Nozzle Post**.
2. Insert **Wand** into pod.
3. Insert **Handle** into wand.
4. Connect **Hose** to back of pod.

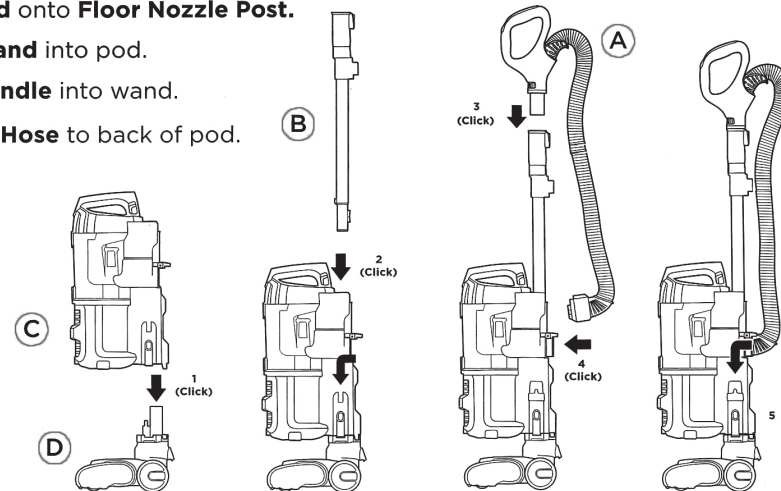

The image shown here is for illustrative purposes only and may be subject to change.



8 1 4 0 0 0 1 5 7

PRINTED IN MEXICO SC: 11-27-2023 / OBPN: N/A / SHNMDL: ZD201\_B / TAB / Elbrd:J.E.