

SAFETY INFORMATION

IMPORTANT SAFETY INFORMATION READ ALL INSTRUCTIONS BEFORE USING THE APPLIANCE

▲ WARNING For your safety, the information in this manual must be followed to minimize the risk of fire, electric shock or personal injury.

- Use this appliance only for its intended purpose as described in this Owner's Manual.
 - This dehumidifier must be properly installed and grounded as described in this manual before it is used.
 - Never operate this dehumidifier in an area that is likely to accumulate standing water. If this condition develops, for your safety disconnect the power supply before stepping into the water.
 - Never unplug your dehumidifier by pulling on the power cord. Always grip plug firmly and pull straight out from the receptacle.
 - Replace immediately all electric service cords that have become frayed or otherwise damaged. A damaged power supply cord must be replaced with a new power supply cord obtained from the manufacturer and not repaired. Do not use a cord that shows cracks or abrasion damage along its length or at either the plug or connector end.
 - If the receptacle does not match the plug, the receptacle must be changed out by a qualified electrician.
 - If the SUPPLY CORD is damaged, it must be replaced by the manufacturer, its service agent, or similarly qualified person in order to avoid a hazard.
 - The appliance shall be installed in accordance with national wiring regulations.
 - Turn the dehumidifier OFF and unplug it before cleaning.
- GE Appliances does not support any servicing of the dehumidifier. We strongly recommend that you do not attempt to service the dehumidifier yourself.
 - For your safety, do not store or use combustible materials, gasoline or other flammable vapors or liquids in the vicinity of this or any other appliance.
 - All dehumidifiers contain refrigerants, which under federal law must be removed prior to product disposal. If you are getting rid of an old product with refrigerants, check with the company handling disposal about what to do.
 - Do not use outdoors.
 - This dehumidifier is intended for indoor residential applications only. This dehumidifier should not be used for commercial or industrial applications.
 - These R410A Dehumidifier Systems require contractors and technicians to use tools, equipment and safety standards approved for use with this refrigerant. DO NOT use equipment certified for R22 refrigerant only.
 - This appliance can be used by persons with reduced physical, sensory, or mental capabilities or lack of experience and knowledge if they have been given supervision or instruction concerning use of the appliance in a safe way and understand the hazards involved.

▲ WARNING USE OF EXTENSION CORDS

- RISK OF FIRE. Could cause serious injury or death.**
- DO NOT use an extension cord with this Dehumidifier.
 - DO NOT use surge protectors or multi-outlet adaptors with this Dehumidifier.

HOW TO CONNECT ELECTRICITY

Do not, under any circumstances, cut or remove the third (ground) prong from the power cord. For personal safety, this appliance must be properly grounded.

DO NOT use an adapter plug with this appliance.

The power cord of this appliance is equipped with a 3-prong (grounding) plug which mates with a standard 3-prong (grounding) wall outlet to minimize the possibility of electric shock hazard from this appliance.

Have the wall outlet and circuit checked by a qualified electrician to make sure the outlet is properly grounded.

Where a 2-prong wall outlet is encountered, it is your personal responsibility and obligation to have it replaced with a properly grounded 3-prong wall outlet.

The dehumidifier should always be plugged into its own individual electrical outlet, which has a voltage rating matching the rating plate.

This provides the best performance and also prevents overloading house wiring circuits, which could cause a fire hazard from overheated wires.

RECYCLING INFORMATION

For appliance recycling information please visit www.geappliances.com/recycling.

READ AND SAVE THESE INSTRUCTIONS

Note: The images shown here are for illustrative purpose only and may be subject to change.



GE APPLIANCES

DEHUMIDIFIER OWNER'S MANUAL

OPERATION INSTRUCTIONS

Controls

Appearance may vary by model.

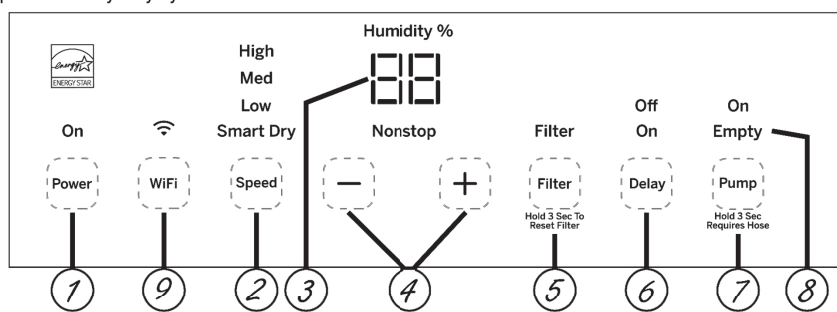

Controls

NOTE: When the bucket is full or removed, the controls cannot be set.

- Power Pad**
Press to turn the dehumidifier on and off.
NOTE: Turning off the power by pressing the Power button does NOT disconnect the appliance from power supply.
- Fan Speed Pad**
Controls the fan speed.
Press to select either **High, Medium, Low, or Smart Dry** fan speed.
Set the fan control to High for maximum moisture removal. When the humidity has been reduced and quiet operation is preferred, set the fan control to Medium or Low. Smart Dry compares the set humidity level with the actual humidity and adjusts the fan speed automatically.
- Display**
Shows the set % humidity level while setting, then shows the actual (+/-5% accuracy) room % humidity level.
- Humidity Set Control Pads**
The humidity level can be set within a range of 35% RH (Relative Humidity) to 80% RH (Relative Humidity) in 5% increments or in Nonstop mode for continuous operation. To set the unit for continuous operation, press the ▼ pad until the "Nonstop" indicator or light is illuminated.
NOTE: If Nonstop is selected, the dehumidifier will operate continuously at its maximum dehumidification settings if attached to a hose to drain or until the bucket is full. For drier air, press the ▼ pad and set to a lower percent value (%). For damper air, press the ▲ pad and set to a higher percent value (%). When you first use the dehumidifier, set the humidity control to 45% or 50%. Allow at least 24 hours for the dehumidifier to achieve the humidity level. If you still have damper air than desired, set the humidity level to a lower setting or select Nonstop for maximum dehumidification.
- Filter Timer**
After 250 hours of operation, the Clean the Filter indicator light

will glow to remind you to clean the filter. Remove the filter and clean it.
Press and hold **Filter** button for 3 seconds to reset the filter reminder. See the Care and Cleaning section.

6. Delay Off

While the dehumidifier is operating press the **Delay** button. Press the ▲ / ▼ buttons to select the number of hours you want the dehumidifier to continue to operate before turning Off.

NOTE: After displaying the time, the Display will revert to showing the current humidity after 5 seconds have passed. Pressing the **Delay** button will display the number of hours left on the delay.

Delay On

While the dehumidifier is off press the **Delay** button.

Press the ▲ / ▼ buttons to select the number of hours you want the dehumidifier to remain off before turning On.
NOTE: The display will show the number of hours left until the dehumidifier turns on.

To cancel the Delay:

Press the **Delay** button once, the hours remaining on the Delay will appear on the display. Press the **Delay** button again and the Delay will be cancelled.

7. Pump (on some models)

Activates the internal pump function. Press for 3 seconds to activate the internal pump for automatic removal of condensate. The internal pump indicator light will remain illuminated after 3 seconds. Press to deactivate the pump. Before turning on the pump, ensure the hose is connected.

8. Empty Indicator

The "Empty" indicator will blink when the bucket is ready to be emptied, or when the bucket is removed and/or not replaced in the proper position.

9. WiFi Connect Pad (on some models)

Enables connection of the dehumidifier to the home WiFi.

NOTE: The image shown here is for illustrative purposes only and may be subject to change. The actual descriptions of control panel and their locations may vary, depending on the model.

Other Features

Alarm

If the bucket is full or missing, an alarm will sound for about 10 seconds to remind you to empty and replace the bucket.

Auto Shut Off

The Water Level Control Switch shuts off the dehumidifier when the bucket is full, or when the bucket is removed and/or not replaced in the proper position.

NOTE: The fan and compressor will stop running as soon as the bucket is removed. The alarm will sound if

the bucket is not replaced in the proper position after 3 minutes.

Auto Defrost

When frost builds up on the evaporator coils, the compressor will cycle off and the fan will continue to run until the frost disappears.

Power Outage

In the case of a power outage or interruption, the unit will automatically restart, in the settings last used, after the power is restored.

Caster Installation

NOTE: This is for 22 and 35 pint models only. Before plugging in the dehumidifier, remove the casters from the bucket and install as shown below.

Installing the Casters

- Remove the 4 casters from the bag taped to the inside of the water bucket lid.
- Carefully lay the dehumidifier down on it's front or back.
- Following the arrows on the base, slide the 4 casters into place.
- Place the unit upright and wait 1 hour before use.

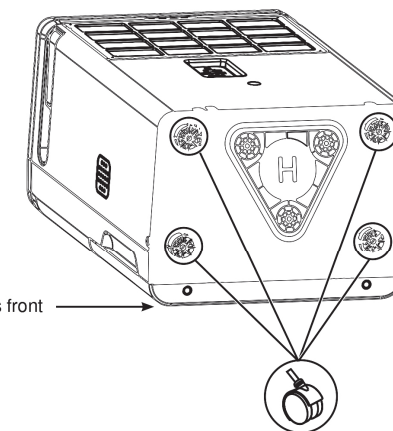

Using the Dehumidifier

When first using the dehumidifier, operate the unit continuously for 24 hours.

How the Dehumidifier Operates

Moist, humid air is drawn over a cold refrigerated dehumidifying coil. Moisture in the air condenses on this coil and drains into a bucket (or through a hose and drain).

Dry, clean air is drawn through the condenser where it is heated and discharged out the top grille into the room.

It is normal for the surrounding air to become slightly warmer as the dehumidifier operates.

Automatic Defrost

When frost builds up on the evaporator coils, the compressor will cycle off and the fan will continue to run until the frost disappears.

When the coil is defrosted, the compressor or fan will automatically restart and dehumidifying will resume.

Choosing a Location

A dehumidifier operating in a basement will have little or no effect in drying an adjacent enclosed storage area, such as a closet, unless there is adequate circulation of air in and out of the area.

• Do not use outdoors.

• This dehumidifier is intended for indoor residential applications only. This dehumidifier should not be used for commercial or industrial applications.

• Place the dehumidifier on a smooth, level floor strong enough to support the unit with a full bucket of water.

• Allow at least 18 inches of air space on all sides of the unit for good air circulation.

• Place the dehumidifier in an area where the temperature will not fall below 41°F (5°C) or above 90°F (32°C). The coils can become covered with frost at temperatures below 41°F, which may reduce performance.

• The suggested range of relative humidity is between 40% and 50%.

• Use the dehumidifier in cooking, laundry and dishwashing areas that have excessive moisture.

NOTE: Place the dehumidifier away from the clothes dryer.

• Use the dehumidifier to prevent moisture damage anywhere books or valuables are stored.

• Use the dehumidifier in a basement to help prevent moisture damage.

• The dehumidifier must be operated in an enclosed area to be most effective.

• Close all doors, windows and other outside openings to the room.

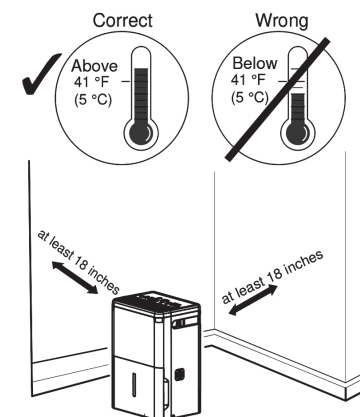

NOTE: The dehumidifier has casters to aid placement, but it should only be rolled on smooth, flat surfaces. Do not attempt to roll the dehumidifier on carpet or over objects.

Water Level

The dehumidifier will turn off automatically when the bucket is full, or when the bucket is removed or not replaced in the proper position.

The bucket must be replaced in the proper position for the dehumidifier to work. The empty indicator will blink and the dehumidifier will not run if the bucket is not in the proper position.

Bucket Operation

DO NOT remove the foam piece and magnet block in the bucket assembly.

If removed the Dehumidifier will not work properly.

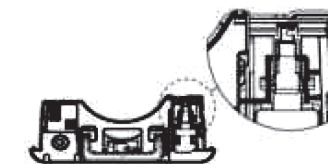

PRINTED IN MEXICO/ SC:04.18.23

obpn:49-5000545 Rev. 1 04-22

shnmdl: APL50LB_B - Pags:TAB elbr:m.c.

8 0 4 1 0 6 5 0 5 A



Always make sure the water bucket is locked into place on the dehumidifier.

Removing Collected Water

There are 3 ways to remove collected water:

- Use the bucket
- Use a garden hose (not supplied)
- Use the internal pump (on some models)

Use the bucket. When the bucket is removed, the unit will shut off. Empty and replace the bucket.

IMPORTANT: Do not use the hose if using the bucket to collect water. When the hose is connected, water will flow through it onto the floor instead of into the bucket.

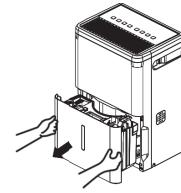

NOTES:

- Do not remove the bucket while the dehumidifier is operating or if it has just stopped operating. This might cause some water to drip from the drain pan.
- The bucket must be in place and securely seated for the dehumidifier to operate.

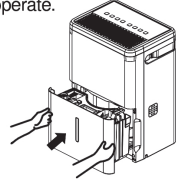

Use a garden hose. Water can be automatically emptied into a floor drain by attaching a garden water hose (not included).

1. Remove the bucket from the front of the unit.
2. Open the drain cover on the side of the unit.

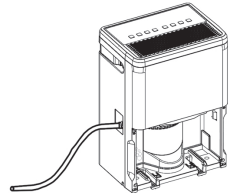

3. Thread a garden hose (not supplied) onto the nozzle and ensure it is seated securely. Cut to length and lead it to the floor drain.

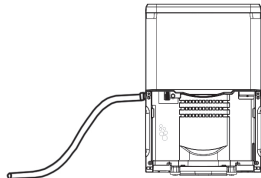

4. Replace the bucket in the unit.

NOTE: The bucket must be in place and securely seated for the dehumidifier to operate. The garden hose must run down from the dehumidifier to the floor drain.

Use the internal pump (on some models)

Water can be automatically emptied into a remote location by attaching the included pump hose.

Care and Cleaning

Turn off the dehumidifier and remove the plug from the wall outlet before cleaning.

Grille and Case

To clean the case:

Use water and a mild detergent. Do not use bleach or abrasives.

Water Bucket

To clean:

Every few weeks, clean the bucket to prevent growth of mold, mildew and bacteria. Partially fill the bucket with clean water and add a little mild detergent. Swish it around in the bucket, empty and rinse.

NOTE: Do not use a dishwasher to clean the water bucket.

To remove:

Remove the bucket and pour out any water.

1. Attach the pump hose to the hose connector by pushing the tube fitting into the connector until it fits into place (should not be able to remove the hose when pulled).
2. Position the hose discharge to the desired location.
3. Make sure the pump is activated. To activate the pump, press and hold the Pump button for 3 seconds. The Pump indicator light will flash then remain illuminated once the 3 seconds are complete.

IMPORTANT: Make sure the condensate hose is properly connected and is not kinked, bent or cracked as this may cause water to flow onto the floor. Please ensure the bucket is empty before putting the unit into pump mode. The bucket must also be fully seated for the pump to work properly. Do not operate the machine if the room temperature is 41°F or below.

NOTE: Maximum lift height is 16ft.

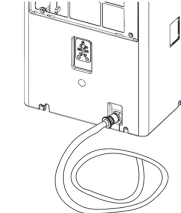

To Install Pump Hose (on some models): Push in hose and gently pull to make sure it is secure. Should not be able to be removed. You should hear a "click" that lets you know the hose is inserted correctly.

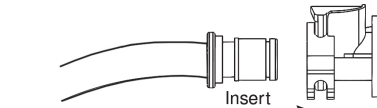

To Release Pump Hose: Press the blue button on top of the connector attached to the dehumidifier and pull the hose out to remove. Be sure to turn off the pump before removing the hose.

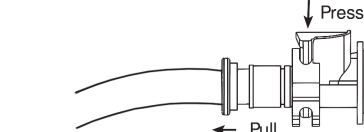

NOTE: DO NOT kink or crimp hose, as it can block water flow.

Air Filter

The air filter behind the rear grille should be checked and cleaned at least every 250 hours of operation or more often if necessary.

After 250 hours of operation, the Filter indicator light will glow to remind you to clean the filter. Remove the filter and clean it. Replace the filter and press and hold the filter button for 3 seconds.

To remove:

Remove the rear grille and the filter will be attached.

To clean:

Clean the filter with warm, soapy water. Rinse and let the filter dry before replacing it.

NOTE: DO NOT put the filter in an automatic dishwasher.

CAUTION

DO NOT operate the dehumidifier without a filter because dirt and lint will clog the unit and reduce performance.

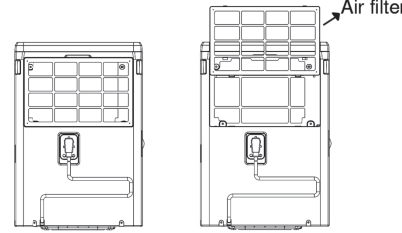

WiFi Setup

GE Appliances SmartHQ (for customers in the United States)

GE Appliances SmartHQ Enabled*. If your Dehumidifier has a Connected Appliance Information label located on the outside as shown below, your dehumidifier is **GE Appliances SmartHQ Enabled**. A WiFi communication card is built into the product allowing it to communicate with your smart phone for remote monitoring, control and notifications. Please visit www.GEAppliances.com/connect to learn more about connected appliance features, and to learn what connected appliance apps will work with your smart phone.

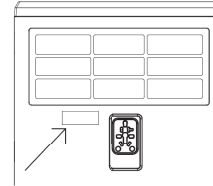
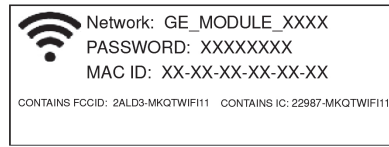

WiFi Connectivity:

For assistance with the appliance or the **ConnectPlus** network connectivity (for models that are WiFi enabled or WiFi optional), please call a Service center.

Getting Started

To connect your dehumidifier, you'll need the GE Appliances App. The app will walk you through the connection process. Download the app from iTunes or Google Play.



All connected appliance data is held in strict accordance with the GE Appliances Connected Data Privacy Policy. Visit geappliances.com/privacy/privacy_policy_connected to view this policy.

Questions about SmartHQ

Get answers you need about setting up WiFi appliances and connecting to your home network in our support articles.

Visit products.geappliances.com/appliance/gea-support-search-content to view wifi connect support articles.

REGULATORY INFORMATION FCC/IC Compliance Statement:

This device complies with Part 15 of the FCC Rules. Operation is subject to the following two conditions:

1. This device may not cause harmful interference.
2. This device must accept any interference received, including interference that may cause undesired operation.

This equipment has been tested and found to comply with the limits for a Class B digital device, pursuant to Part 15 of the FCC Rules. These limits are designed to provide reasonable protection against harmful interference in a residential installation. This equipment generates uses and can radiate radio frequency energy and, if not installed and used in accordance with the instructions, may cause harmful interference to radio communications. However, there is no guarantee that interference will not occur in a particular installation. If this equipment does cause harmful interference to radio

or television reception, which can be determined by turning the equipment off and on, the user is encouraged to try to correct the interference by one or more of the following measures:

- Reorient or relocate the receiving antenna.
- Increase the separation between the equipment and receiver.
- Connect the equipment into an outlet on a circuit different from that to which the receiver is connected.
- Consult the dealer or an experienced radio/television technician for help.

Labelling: Changes or modifications to this unit not expressly approved by the manufacturer could void the user's authority to operate the equipment.

*Select Models Only

This product has Wi-Fi capability and requires Internet connectivity and a wireless router to enable interconnection with an Energy Management System, and/or with other external devices, systems or applications.

Troubleshooting Tips... Before you call for service

Save time and money! Review the charts on the following pages first and you may not need to call for service.

Problem	Possible Cause	What To Do
Dehumidifier does not start	The dehumidifier is unplugged.	Makes sure the dehumidifier's plug is pushed completely into the outlet.
	The fuse is blown/circuit breaker is tripped.	Check the house fuse/circuit breaker box and replace the fuse or reset the breaker.
	Dehumidifier has reached its set humidity level or bucket is full.	The dehumidifier automatically turns off when either condition occurs. Change to a lower setting or empty the bucket and replace properly.
	Bucket is not in the proper position.	The bucket must be in place and securely seated for the dehumidifier to operate.
Power Failure.		There is a protective time delay (up to 3 minutes) to prevent tripping of the compressor overload. For this reason, the unit may not start normal dehumidification for 3 minutes after it turned back on.

Dehumidifier does not dry the air as it should	Did not allow enough time to remove the moisture.	When first installed, allow at least 24 hours to maintain the desired dryness.
	Airflow is restricted.	Make sure there are no curtains, blinds or furniture blocking the top or back of the dehumidifier. See the Choosing a Location section.
	Dirty Filter	See the Care and Cleaning section.
	The Humidity Control may not be set low enough.	For drier air, press the ▼ pad and set to a lower percent value (%) or at the Nonstop setting for maximum dehumidification.
	Doors and windows may not be closed tightly.	Check that all doors, windows and other openings are securely closed.
	Clothes dryer may be blowing moisture-laden air into the room.	Install the dehumidifier away from the dryer. The dryer should be vented to the outside.
Room temperature is too low.	Moisture removal is best at higher room temperatures. Lower room temperatures will reduce the moisture removal rate. Models are designed to be operated at temperatures above 41°F (5°C).	
Dehumidifier runs too much	Area to be dehumidified is too large.	The capacity of your dehumidifier may not be adequate
	Doors and windows are open.	Close all doors and windows to the outside.
Frost appears on the coils	Room temperature is below 41°F (5°C)	Please operate unit at temperatures above 41 F (5 C). Frost will usually disappear within 60 minutes. Under certain conditions, frost may appear on the coils of your dehumidifier at temperatures above 41°F (5°C). This is normal and frost will usually disappear within 60 minutes. See the Automatic Defrost section.
Fan noise	Air is moving through the dehumidifier.	This is normal.
Water on floor	Hose connection may be loose.	Check the hose connection. See the Removing Collected Water section.
	Intended to use the bucket to collect water, but a hose was attached	Disconnect the hose if using a bucket to collect water. See the Removing Collected Water section.
Bucket Full LED light flashing and alarm sounds while drain hose is connected	Drain hose not tight on fitting.	Check drain hose connection.
	Drain hose is kinked.	Ensure the drain hose is pointed straight down to the floor and is not kinked in anyway.
Bucket fills up when using drain pump (on some models)	Unit not in pump mode	Ensure pump is turned on and pump light is illuminated
	Pump hose not installed	Ensure pump hose is properly installed on back of unit
	Water level sensor issue	This may be caused by very humid conditions or error with float sensor. Check unit for a P1 error code on display. If this is present - turn off the unit, unplug unit for a few seconds, plug back in and turn on the unit to reset sensor. If this error continues to occur refer to warranty section for exchange options.

REFURBISHED PRODUCT LIMITED THIRTY DAY WARRANTY

The **Refurbished Product Service Center** offers the following WARRANTY to the ORIGINAL purchaser of a product which we have refurbished.

This product that has been refurbished is warranted against any electronic or mechanical defects for a period of THIRTY DAYS from the date of the original purchase by the consumer. Since this unit was sold as a refurbished item, the warranty does not apply to any cosmetic appearance items such as scratches. Should a defect occur, the **Refurbished Product Service Center** will repair or, at its option, replace defective unit/parts with new or rebuilt materials without charge for either parts or labor. Replacement unit/parts will be warranted for the remaining portion of the original warranty period.

This warranty does not cover installation or damage from accident, misuse, abuse, improper wiring, incorrect voltage, operating the unit against the instructions in the owner's manual or any product which has been opened, altered, or tampered with.

This warranty does not cover costs for removal and or installation of the unit for repair. Under no circumstances shall the service center be liable for any special, incidental or consequential damages or for any other expenses incurred by reason of use or sale of this product. This warranty is in lieu of any other warranties expressed or implied warranty of merchantability of fitness for particular use or otherwise.

This warranty gives the consumer specific legal rights and they may also have other rights which vary from State to State. Some States do not follow the exclusion or limitation of incidental or consequential damages, hence the above exclusion and limitations may not apply.

Refurbished Product Service Center
13225 Marquardt Avenue Santa Fe Springs, CA 90670

WARRANTY REPAIR INFORMATION

If you need service on your unit during the 30 day warranty period; please go to www.ConsumerServiceRefurbish.com or call the Refurbished Product Service Center at 562-946-3531 to obtain the required claim number. Once you obtain your claim number, pack the unit properly (the original carton is ideal for this purpose) along with a copy of your purchase receipt. Send the unit freight prepaid and insured to:

Refurbished Product Service Center,
Att: Customer Service Department 13225 Marquardt Avenue Santa Fe Springs, CA 90670

Your unit will be promptly exchanged and returned to you.

We will refuse to accept delivery of the returned unit unless the assigned claim number appears on the outside of the shipping carton.

Owner's Information

(Keep for your permanent records)

NAME: _____

ADDRESS: _____

CITY: _____ STATE: _____ ZIP CODE: _____

PHONE: _____ E-MAIL: _____

MODEL: _____ SERIAL NO.: _____

804106505A