

## IMPORTANT SAFETY INFORMATION READ ALL INSTRUCTIONS BEFORE USING THE APPLIANCE

**⚠ WARNING** For your safety, the information in this manual must be followed to minimize the risk of fire, electric shock or personal injury.

- Use this appliance only for its intended purpose as described in this Owner's Manual.
- This air conditioner must be properly installed in accordance with the Installation Instructions before it is used.
- Never unplug your air conditioner by pulling on the power cord. Always grip plug firmly and pull straight out from the receptacle.
- Replace immediately all electric service cords that have become frayed or otherwise damaged. A damaged power supply cord must be replaced with a new power supply cord obtained from the manufacturer and not repaired. Do not use a cord that shows cracks or abrasion damage along its length or at either the plug or connector end.
- Turn the unit OFF and unplug your air conditioner before cleaning.
- For your safety...do not store or use combustible materials, gasoline or other flammable vapors or liquids in the vicinity of this or any other appliance.
- If the receptacle does not match the plug, the receptacle must be changed out by a qualified electrician.



**⚠ WARNING** Risk of Fire or Explosion. This unit contains flammable refrigerant. Additional safety precautions must be followed.

- Do not use means to accelerate the defrosting process or to clean, other than those recommended by the manufacturer.
- The appliance shall be stored in a room without continuously operating ignition sources (for example: open flames, an operating gas appliance or an operating electric heater).
- Do not pierce or burn refrigerant tubing. Be aware that refrigerants may not contain an odor.
- Keep ventilation openings clear of obstruction.
- When handling, installing, and operating the appliance, care should be taken to avoid damage to the refrigerant tubing.
- Do not drill holes in the unit.
- Maintenance, cleaning, and service should only be performed by technicians properly trained and qualified in the use of flammable refrigerants.
- GE Appliances does not support any servicing of the air conditioner.
- Dispose of air conditioner in accordance with Federal and Local Regulations. Flammable refrigerants require special disposal procedures. Contact your local authorities for the environmentally safe disposal of your air conditioner.

**⚠ WARNING** USE OF EXTENSION CORDS

- RISK OF FIRE. Could cause serious injury or death.**
- DO NOT use an extension cord with this Window Air Conditioner.
  - DO NOT use surge protectors or multi-outlet adaptors with this Window Air Conditioner.

### HOW TO CONNECT ELECTRICITY

Do not, under any circumstances, cut or remove the third (ground) prong from the power cord. For personal safety, this appliance must be properly grounded.

**DO NOT use an adapter plug with this appliance.**

The power cord of this appliance is equipped with a 3-prong (grounding) plug which mates with a standard 3-prong (grounding) wall outlet to minimize the possibility of electric shock hazard from this appliance.

Power cord includes a current interrupter device. A test and reset button is provided on the plug case. The device should be tested on a periodic basis by first pressing the **TEST** button and then the **RESET** button while plugged into the outlet. If the **TEST** button does not trip or if the **RESET** button will not stay engaged, discontinue use of the air conditioner and contact a qualified service technician.

Have the wall outlet and circuit checked by a qualified electrician to make sure the outlet is properly grounded. Where a 2-prong wall outlet is encountered, it is your personal responsibility and obligation to have it replaced with a properly grounded 3-prong wall outlet.

The air conditioner should always be plugged into its own individual electrical outlet which has a voltage rating that matches the rating plate.

This provides the best performance and also prevents overloading house wiring circuits which could cause a fire hazard from overheated wires.

See the Installation Instructions, **Electrical Requirements** section for specific electrical connection requirements.

**⚠ WARNING** Chemical Burn Hazard. Keep batteries away from children.

- This product contains a lithium button/coin cell battery. If a new or used lithium button/coin cell battery is swallowed or enters the body, it can cause severe internal burns and can lead to death in as little as 2 hours. Always completely secure the battery compartment. If the battery compartment does not close securely, stop using the product, remove the batteries, and keep it away from children.
- If you think batteries might have been swallowed or placed inside any part of the body, seek immediate medical attention.
- The cells shall be disposed of properly, including keeping them away from children.
- Even used cells may cause injury.

## USING THE AIR CONDITIONER

### Controls

Features and appearance will vary.

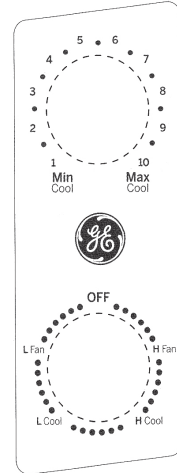

Air Conditioner Controls

### Controls

#### 1. Temperature Control

This determines how much cooling is provided. **Max Cool - 10** provides the most cooling and **Min Cool - 1** provides the least.

#### Cooling Descriptions

**For Normal Cooling**—Select 4-7 on the dial with **HCool** or **LCool** selected.

**For Maximum Cooling**—Select 8-10 on the dial with **HCool** selected.

**For Quieter and Nighttime Cooling**—Select 1-3 on the dial with **LCool** selected.

#### 2. Mode Control

**HCool** and **LCool** provide cooling with different fan speeds.

**HFan** and **LFan** provide circulation and filtering without cooling.

**NOTE:** If you move the Temperature control from a cool setting to a fan setting or power off the unit while cooling, wait at least 3 minutes before switching back to a cool setting.

**Note:** The remote control vary depend of model.

The buttons on the remote control may have a different name or location than the remote control shows in this manual.

### Air Direction

Use the lever to adjust the air direction left to right.

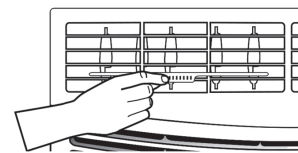

## Care and Cleaning

### Do Not Operate in Freezing Outdoor Conditions

This cool-only air conditioner was not designed for freezing outdoor conditions. It must not be used when the outdoor temperature is below freezing (32°F).

### Grille and Case

Turn the air conditioner off and remove the plug from the wall outlet before cleaning.

To clean, use water and a mild detergent. Do not use bleach or abrasives.

### Air Filter

The air filter behind the front grille should be checked and cleaned at least every 30 days or more often if necessary.

#### To remove:

Slide the filter from the left side of the unit. Remove the filter.

Clean the filter with warm, soapy water. Rinse and let the filter dry before replacing it. Do not clean the filter in a dishwasher.

**⚠ CAUTION** DO NOT operate the air conditioner without a filter because dirt and lint will clog it and reduce performance.

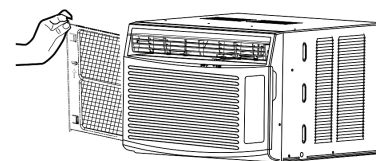

### Outdoor Coils

The coils on the outdoor side of the air conditioner should be checked regularly. If they are clogged with dirt or soot, they may be professionally cleaned.

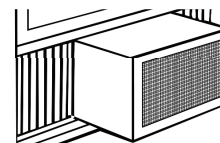

## BEFORE YOU BEGIN

Read these instructions completely and carefully.

- IMPORTANT** — Save these instructions for local inspector's use.
- IMPORTANT** — Observe all governing codes and ordinances.
- Note to Installer** — Be sure to leave these instructions with the Consumer.
- Note to Consumer** — Keep these instructions for future reference.
- Skill level** — Installation of this appliance requires basic mechanical skills.
- Completion time** — Approximately 1 hour
- We recommend that two people install this product.
- Proper installation is the responsibility of the installer.
- Product failure due to improper installation is not covered under the Warranty.
- You **MUST** use all supplied parts and use proper installation procedures as described in these instructions when installing this air conditioner.

## ELECTRICAL REQUIREMENTS (CONT)

Power cord includes a current interrupter device. A test and reset button is provided on the plug case. The device should be tested on a periodic basis by first pressing the **TEST** button and then the **RESET** button while plugged into the outlet. If the **TEST** button does not trip or if the **RESET** button will not stay engaged, discontinue use of the air conditioner and contact a qualified service technician.

## TOOLS YOU WILL NEED (Not supplied)

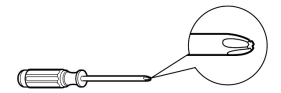

Phillips head screwdriver

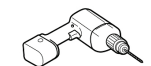

Drill and 1/8" drill bit



Pencil

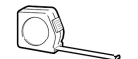

Ruler or tape measure



Level



Scissors or knife

## ELECTRICAL REQUIREMENTS

These models require a 115/120-volt AC, 60-Hz grounded outlet protected with a 15-amp time-delay fuse or circuit breaker.

The 3-prong grounding plug minimizes the possibility of electric shock hazard. If the wall outlet you plan to use is only a 2-prong outlet, it is your responsibility to have it replaced with a properly grounded 3-prong wall outlet.

**⚠ CAUTION**

Do not, under any circumstances, cut or remove the third (ground) prong from the power cord.

Do not change the plug on the power cord of this air conditioner.

Aluminum house wiring may present special problems—consult a qualified electrician.

## PARTS INCLUDED (Appearance may vary)

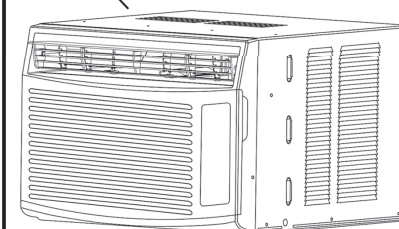
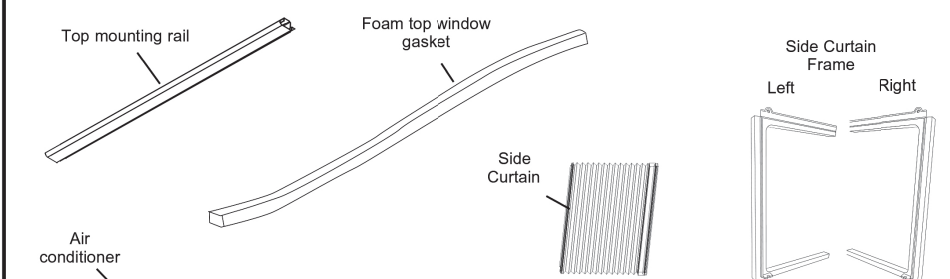

Type A



Type B



Side Brackets



Window locking bracket

## Installation Instructions - cont.

### 1. WINDOW REQUIREMENTS

- These instructions are for a standard double-hung window. You will need to modify them for other types of windows.
- The air conditioner can be installed without the side curtain panels if needed to fit in a narrow window. See the window opening dimensions.
- All supporting parts must be secured to firm wood, masonry or metal.
- The electrical outlet must be within reach of the power cord.
- Follow the dimensions in the table and illustration for your model.

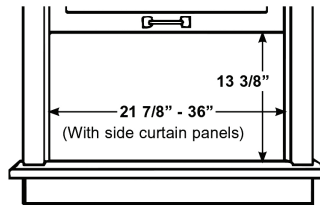

### 2. STORM WINDOW REQUIREMENTS

A storm window frame will not allow the air conditioner to tilt toward the outside, and will keep it from draining properly. To adjust for this, attach a piece of wood to the sill.

#### WOOD PIECES

**WIDTH:** 2"

**LENGTH:** Long enough to fit inside the window frame.

**THICKNESS:** To determine the thickness, place a piece of wood on the sill to make it 1/2" higher than the top of the storm window frame or the vinyl frame.

Attach securely with nails or screws provided by the installer.

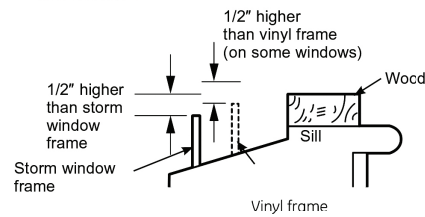

### 3. PREPARE THE AIR CONDITIONER

**A.** Install the top mounting rail with 3 Type A screws

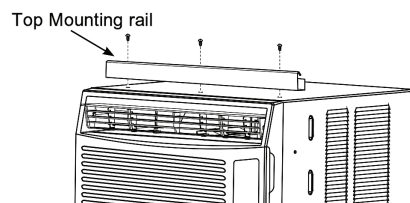

**B.** Slide the side curtain panels into the side panel rails.

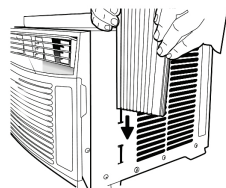

### 3. PREPARE THE AIR CONDITIONER (continues)

**C.** Slide left and right side curtain frames into top and bottom rails. Make sure that side curtains snap into side of the frames.

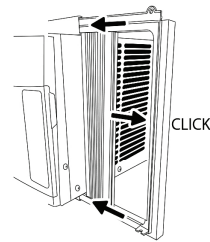

### 4. INSTALL THE AIR CONDITIONER IN THE WINDOW

**A.** Measure the width of the window opening and mark the center line on the inside window sill. Place the unit in the window. Lower the window to hold unit in place.

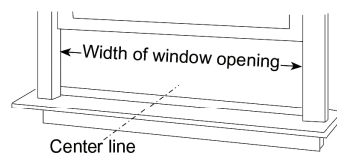

**B.** Set the air conditioner in the window so that is centered. Place the air conditioner so that front edge of the bottom mounting rail is against the back edge of the sill.

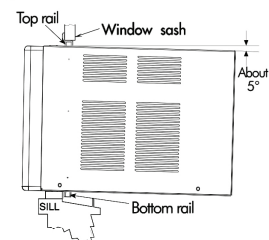

**C.** Install the side bracket into the unit and into the window sill using two 1" wood screws provided. Repeat on other side.

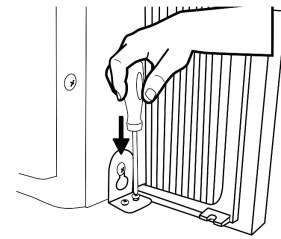

**D.** Bring the window down so that the front edge of the top mounting is in front of the window. Make sure that the air conditioner is level or tilting slightly to the outside.

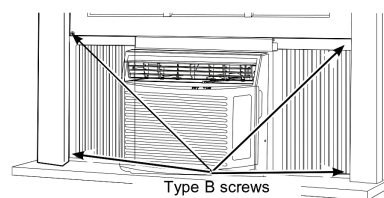

**E.** Extend the curtain panels until they fill the window. Mark the location of the holes in each corner. Use the drill and 1/8" drill bit to drill pilot holes. Use 4 type B screws to secure the side panels in place.

## Installation Instructions - cont.

### 5. INSTALL WINDOW LOCKING BRACKET AND FOAM TOP WINDOW GASKET

Use Type B Screw to install the window lock bracket on top of the bottom window.

#### CAUTION

**A.** To prevent broken glass or damage to windows, on vinyl or other similarly constructed windows, attach the window locking bracket to the window side jamb with one Type B screw.

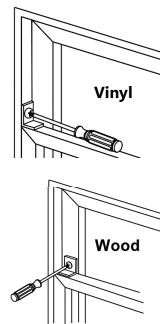

**B.** Cut the foam top window gasket to the window width.

**C.** Stuff the foam between the glass and the window to prevent air and insects from getting into the room.

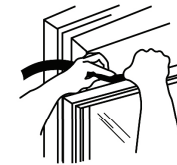

**NOTE:** If the gasket supplied does not fit your window, obtain appropriate material locally to provide a proper installation seal.

## Troubleshooting Tips... Before you call for service

Save time and money! Review the charts on the following pages first and you may not need to call for service.

Problem	Possible Cause	What To Do
Air conditioner does not start.	The unit is unplugged.	Make sure the air conditioner plug is pushed completely into the outlet.
	The fuse is blown/circuit breaker is tripped.	Check the house fuse/circuit breaker box and replace the fuse or reset the breaker.
	Power Failure.	The unit will automatically restart in the setting last used after the power is restored.  There is a protective time delay (approximately 3 minutes) to prevent tripping of the compressor overload. For this reason, the unit may not start normal cooling for 3 minutes after it is turned back on.
	The current interrupter device is tripped.	Press RESET button located on the power cord plug.  If the RESET button will not stay engaged, discontinue use of the air conditioner and contact a qualified service technician.
Air conditioner does not cool as it should.	Indoor airflow is restricted.	Make sure there are not curtains, blinds or furniture blocking the front of the air conditioner.
	The temp control may not be set properly.	Turn the temperature control to a higher number.
	The air filter is dirty.	Clean the filter at least every 30 days. See Care and Cleaning section.
	The room may have been hot.	When the air conditioner is first turned on, you need to allow time for the room to cool down.
	Cold air is escaping.	Check for open furnace registers and cold air returns.
Cooling coils have iced up.	See "Air conditioner freezing up" below.	
Air conditioner freezing up	Ice blocks the air flow and stops the air conditioner from cooling the room.	On models with control knobs, set the mode control at High Fan or High Cool with the Temp at 1 or 2.
Water drips outside	Hot, humid weather.	This is normal.
Water drips inside	The air conditioner is not tilted to the outside.	For proper disposal, make sure the air conditioner slants slightly from the case front to the rear.
Water collects in base pan	Moisture removed from air and drain into base pan.	This is normal for a short period in areas with little humidity; normal for a longer period in very humid areas.

## Normal Operating Sounds

- You may hear a pinging noise caused by water being picked up and thrown against the condenser on rainy days or when the humidity is high. This design feature helps remove moisture and improve efficiency.
- You may hear the thermostat click when the compressor cycles on and off.
- Water will collect in the base pan during high humidity or on rainy days. The water may overflow and drip from the outdoor side of the unit.
- The fan may run even when the compressor does not.
- Water droplets being thrown against the outside coils can make a pinging noise. This helps cool the condenser. You can reduce this noise by removing the subbase water plug.

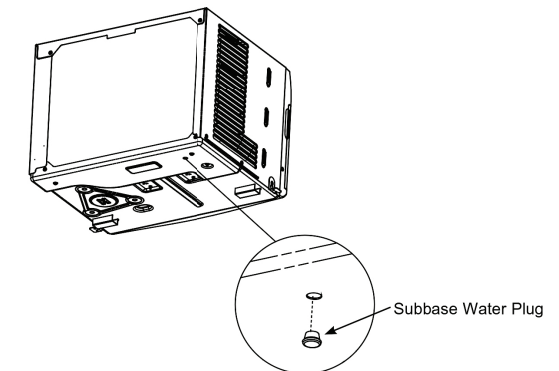

Removing this plug will lower the Energy Efficiency of your unit.

**NOTE:** Do not drill hole in the base pan.

## REFURBISHED PRODUCT LIMITED THIRTY DAY WARRANTY

The **Refurbished Product Service Center** offers the following WARRANTY to the ORIGINAL purchaser of a product which we have refurbished.

This product that has been refurbished is warranted against any electronic or mechanical defects for a period of THIRTY DAYS from the date of the original purchase by the consumer. Since this unit was sold as a refurbished item, the warranty does not apply to any cosmetic appearance items such as scratches. Should a defect occur, the **Refurbished Product Service Center** will repair or, at its option, replace defective unit/parts with new or rebuilt materials without charge for either parts or labor. Replacement unit/parts will be warranted for the remaining portion of the original warranty period.

This warranty does not cover installation or damage from accident, misuse, abuse, improper wiring, incorrect voltage, operating the unit against the instructions in the owner's manual or any product which has been opened, altered, or tampered with.

This warranty does not cover costs for removal and/or installation of the unit for repair. Under no circumstances shall the service center be liable for any special, incidental or consequential damages or for any other expenses incurred by reason of use or sale of this product. This warranty is in lieu of any other warranties expressed or implied warranty of merchantability of fitness for particular use or otherwise.

This warranty gives the consumer specific legal rights and they may also have other rights which vary from State to State. Some States do not follow the exclusion or limitation of incidental or consequential damages, hence the above exclusion and limitations may not apply.

**Refurbished Product Service Center**  
13225 Marquardt Avenue Santa Fe Springs, CA 90670

## WARRANTY REPAIR INFORMATION

If you need service on your unit during the 30 day warranty period; please go to [www.ConsumerServiceRefurbish.com](http://www.ConsumerServiceRefurbish.com) or call the Refurbished Product Service Center at 562-946-3531 to obtain the required claim number. Once you obtain your claim number, pack the unit properly (the original carton is ideal for this purpose) along with a copy of your purchase receipt. Send the unit freight prepaid and insured to:

**Refurbished Product Service Center,**  
Att: Customer Service Department 13225 Marquardt Avenue Santa Fe Springs, CA 90670

Your unit will be promptly exchanged and returned to you.

We will refuse to accept delivery of the returned unit unless the assigned claim number appears on the outside of the shipping carton.

**Owner's Information**  
(Keep for your permanent records)

NAME: \_\_\_\_\_

ADDRESS: \_\_\_\_\_

CITY: \_\_\_\_\_ STATE: \_\_\_\_\_ ZIP CODE: \_\_\_\_\_

PHONE: \_\_\_\_\_ E-MAIL: \_\_\_\_\_

MODEL: \_\_\_\_\_ SERIAL NO.: \_\_\_\_\_



PRINTED IN MEXICO Elbrd: Y.T.  
OBPN: 0011500765 49-5000095 Rev.0 08-18 GEA  
SC: 07-01-2019\_TAB MODEL: AHV05LY\_B

