

NINJA®

PB040/050

Series

SINGLE-SERVE

PODS & GROUNDS

OWNER'S GUIDE

SPECIALTY COFFEE MAKER





814100145



Please read this manual carefully before operating your unit and retain for future reference.

IMPORTANT SAFEGUARD INSTRUCTIONS

PLEASE READ CAREFULLY BEFORE USE • FOR HOUSEHOLD USE ONLY

	Read and review instructions to understand operation and use of product.
	Indicates the presence of a hazard that can cause personal injury, death or substantial property damage if the warning included with this symbol is ignored.
	Avoid contact with hot surface. Always use hand protection to avoid burns.
	For indoor use only.

⚠ WARNING To reduce the risk of fire, electric shock, serious injury, death, or damage when using this appliance, follow these basic safety precautions.

General Precautions

- 1 To eliminate a choking hazard for young children, discard all packaging materials immediately upon unpacking.
- 2 This appliance can be used by persons with reduced physical, sensory or mental capabilities or lack of experience and knowledge if they have been given supervision or instruction concerning use of the appliance in a safe way and understand the hazards involved.
- 3 To reduce the risk of electric shock, this appliance has a polarized plug (one blade is wider than the other). As a safety feature, this plug will fit into a polarized outlet only one way. If the plug does not fit fully into the outlet, reverse the plug. If it still does not fit, contact a qualified electrician. **DO NOT** force into outlet or try to modify to fit.
- 4 Keep the appliance and its cord out of reach of children. **DO NOT** allow the appliance to be played with or used by children. Close supervision is necessary when used near children.
- 5 To protect against fire, electric shock, and injury to persons, **DO NOT** immerse cord, plugs, or body of machine in water or other liquid.
- 6 **NEVER** carry the appliance by the power cord or pull it to disconnect from electrical socket; instead grasp the plug and pull to disconnect.
- 7 **DO NOT** operate any appliance with a damaged cord or plug, or after the appliance malfunctions, or has been dropped or damaged in any manner. contact a service center.
- 8 For household and countertop use only. **DO NOT** let the power cord hang over the edge or touch hot surfaces such as the stove.
- 9 **NEVER** use socket below counter.
- 10 To avoid risk of fire, electrical shock, or damage to the coffee maker, **DO NOT** use coffee maker in an appliance garage.
- 11 Unplug from outlet when either the appliance or display clock is not in use, and before cleaning.
- 12 Turn off and allow to cool before putting on or taking off parts, and before cleaning the appliance.

Operating Notice

- 13 To disconnect, turn any control to "OFF," then remove plug from wall outlet.
- 14 The use of an accessory not recommended by the manufacturer may create an overflow condition and scalding hazard, or result in fire, electric shock, or personal injury.
- 15 ALWAYS use appliance on a clean, dry, level surface.
- 16 **DO NOT** place on or near a hot gas or electric burner or in a heated oven.
- 17 **DO NOT** use this appliance for anything other than its intended use.
- 18 **DO NOT** use outdoors.
- 19 **DO NOT** touch hot surfaces. Use handles or knobs.
- 20 To avoid contact with steam and hot surfaces, **DO NOT** reach across top of coffee maker to froth.
- 21 **ALWAYS** place a vessel or cup beneath the nozzle to receive the brewed coffee.
- 22 **DO NOT** open brew chamber during brew cycle and cleaning cycle. Scalding may occur.
- 23 **DO NOT** remove the vessel or cup while the appliance is running.
- 24 **DO NOT** fill water reservoir with anything other than water, as other liquids may damage your coffee maker. Vinegar can be used, but ONLY for running a clean cycle.
- 25 **DO NOT** overfill the water reservoir. Fill water only to the MAX line.
- 26 Keep lid on water reservoir when brewing.
- 27 **DO NOT** run the appliance without water.
- 28 **DO NOT** brew ground coffee without a permanent filter installed in the brew basket.
- 29 Exceeding maximum Coffee Measurement Chart capacity may cause overflow. **DO NOT** use fine or espresso ground coffee.

Ninja® Pod Adapter

- 30 Only use capsules/pods intended for this appliance. If the capsule/pod does not fit, do not force it into the appliance.
- 31 Ensure the pod is not damaged, torn, or expired.

Care & Maintenance

- 32 Unplug the coffee maker from outlet when not in use and before cleaning.
- 33 To prevent illness from bacterial growth in the appliance, follow all cleaning instructions in the Care & Maintenance section of this Owner's Guide.
- 34 Clean the system on a weekly basis.
- 35 If the product is not operating properly, contact a service center.
- 36 Cleaning and user maintenance shall not be done by children.

Cord Statement

- 37 A short power-supply cord is provided to reduce the risks resulting from becoming entangled in or tripping over a longer cord.
- 38 **DO NOT** use extension cords with this product.

⚠ WARNING ⚠
Risk of fire or electric shock.
Do not remove bottom cover.

READ AND SAVE THESE INSTRUCTIONS

USING THE CONTROL PANEL

- 1 Power Button
- 2 Brew Style Button
- 3 Brew Size Button
- 4 Start/Cancel Brew Button
- 5 Intelligent Clean Cycle Button
- 6 Smart Sensing Mode Indicators
- 7 Intelligent Clean Cycle Indicator (Orange)

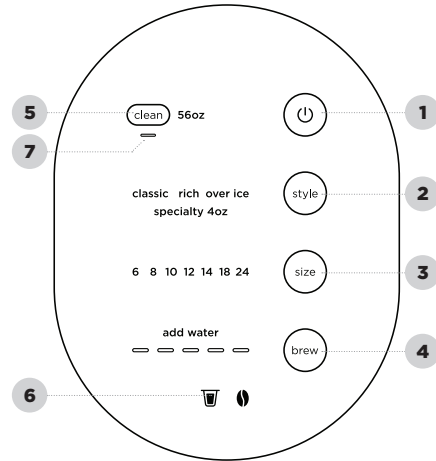

NOTE: The images shown here are for illustrative purposes only and may be subject to change, the actual descriptions of control panel and their locations may vary depending on the model.

NOTE: In order to ensure the highest possible standard for refurbished items, all units are thoroughly inspected as part of the process. For this item, water may be used during the refurbishing process and so; you may notice some condensation in the water reservoir. It is recommended to rinse the water reservoir with fresh water prior to its first use.

HIGH-ALTITUDE CALIBRATION BREW

Required for users in high-altitude areas. Not running the high-altitude calibration brew in a high-altitude area will result in excessive steaming during brewing.

Because water boils at a lower temperature at higher altitudes, running a calibration cycle before your first brew allows the coffee maker to detect the boiling point of water at your location. Running a calibration cycle will help deliver a consistent brew each time.

- 1 Fill the water reservoir up to, but not exceeding, the MAX line.
- 2 Insert the brew basket and close the coffee maker lid, then place a 24 oz. cup or travel mug underneath the nozzle.
- 3 Power on the unit and press and hold the BREW and CLEAN buttons until you hear a confirmation sound.
- 4 A calibration cycle will begin, and the progress bar will advance until the altitude calibration is complete. The coffee maker will beep when completed. Discard the water in the 24 oz. cup or travel mug.

NOTE: This calibration is permanently saved and will not be reset if power is lost or unit is unplugged. The coffee maker can be recalibrated at any time.

USING THE NINJA POD ADAPTER AND PERMANENT FILTER

The coffee maker comes with the unique Ninja Pod Adapter already installed in the brew basket, and the Permanent Filter located in the Adapter Storage Bin on the bottom right side of the coffee maker. Always ensure the Ninja Pod Adapter or Permanent Filter is installed over the brew basket.



INSTALLING THE NINJA POD ADAPTER

Place the Ninja Pod Adapter in the brew basket, ensure the handle is aligned with the brew basket handle, and press down on the Ninja Pod Adapter firmly until it clicks into place.

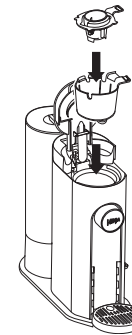





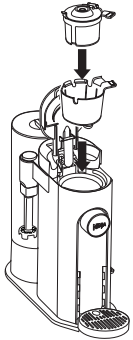

INSTALLING THE PERMANENT FILTER

Place the Permanent Filter in the brew basket and ensure the handle is aligned with the brew basket handle.



SMART SENSING MODE INDICATORS

MODE INDICATORS	STATE
 	Grounds: The Permanent Filter is inserted; shut the coffee maker lid and the coffee maker is ready to brew grounds.
 	Pods: The Ninja® Pod Adapter is inserted; shut the coffee maker lid and the coffee maker is ready to brew pods.
 	No State: One of the above criteria has not been met.

PRIMING YOUR NINJA SINGLE SERVE SPECIALTY COFFEE MAKER

IMPORTANT: Ensure you prime your coffee maker before your first brew.

- 1 Clean all accessories before your first brew.
- 2 Plug in the power cord and the coffee maker will turn on automatically.
- 3 Lift the water reservoir off its base. Remove the reservoir lid. Fill the reservoir up to at least the 24 oz. line with fresh water and place it on the base.

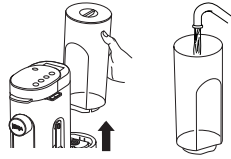

NOTE: We recommend using cool or room temperature water in the reservoir. **DO NOT** fill with hot or boiling water.

- 4 Insert the brew basket and Permanent Filter and close the lid. Do not add coffee.
- 5 Place a 24 oz. cup or travel mug under the nozzle and prime the system by running a 24 oz. Classic brew with water only. After the brew is complete, discard the water. You are now ready to brew coffee.

USING THE NINJA SINGLE SERVE SPECIALTY COFFEE MAKER

BREW VOLUMES AND MEASUREMENTS

Each size and brew style produces a different amount of coffee to optimize strength and flavor.

NOTE: The coffee grounds will absorb some of the water that is brewed; this will cause slight variability in brew volumes. Brew volumes may be slightly larger or smaller than what is stated due to various factors in the system.

APPROXIMATE BREW VOLUMES

Size	GROUNDS		
	Classic	Rich	Over Ice (filled with ice)
6 oz.	6 oz.	5 oz.	6 oz.
8 oz.	8 oz.	7 oz.	8 oz.
10 oz.	10 oz.	8 oz.	10 oz.
12 oz.	12 oz.	10 oz.	12 oz.
14 oz.	14 oz.	12 oz.	14 oz.
18 oz.	18 oz.	16 oz.	18 oz.
24 oz.	24 oz.	22 oz.	24 oz.

NOTE: There may be some water left in the reservoir after your brew. This is normal and keeps the coffee maker from running out of water.

Size	PODS		
	Classic	Rich	Over Ice (filled with ice)
6 oz.	6 oz.	6 oz.	6 oz.
8 oz.	8 oz.	8 oz.	8 oz.
10 oz.	10 oz.	9 oz.	10 oz.
12 oz.	12 oz.	11 oz.	12 oz.

NOTE: You do not need to adjust the size for Specialty brew; it always yields approximately 4 oz.

BREWING STYLES



Smooth, well-balanced flavor.



More intense flavor that stands up to milk, cream, or flavoring.



Specially designed to brew hot over ice for freshly brewed iced coffee that is not watered down.
Always fill your vessel to the top with ice cubes before brewing Over Ice.



A super-rich concentrate that allows you to make coffee-based drinks like cappuccinos and lattes.
Will only brew 4 oz. (not included on all models)

NOTE: Over Ice brew is designed to produce a concentrated brew into a vessel filled with ice. It is normal for some ice in the vessel to melt as the coffee is brewed, and this will produce a cold beverage with the ideal strength and flavor.

NOTE: Rich brew will use slightly less water and yield slightly less brewed coffee than Classic brew. See Approximate Brew Volumes chart for additional information.

BREWING PODS

- 1 To prepare for brewing using pods, open the coffee maker lid and ensure the brew basket and Ninja Pod Adapter are installed and handles are aligned.

IMPORTANT: Ensure the pod is not damaged, torn, or expired. **DO NOT** remove the top of the K-Cup Pod.

- 2 Place the pod in the Ninja Pod Adapter.

NOTE: Reusable K-Cup Coffee Filters are not compatible with the Ninja Pod Adapter.

HIGH-ALTITUDE BREWING: Before closing the coffee maker lid to start a brew, using your fingers, carefully apply pressure on the K-Cup Pod until the bottom of the K-Cup Pod is punctured by the exit needle, and the pod is fully seated in the pod holder. This releases excessive gas built up from the high altitude and prevents pod blowout.

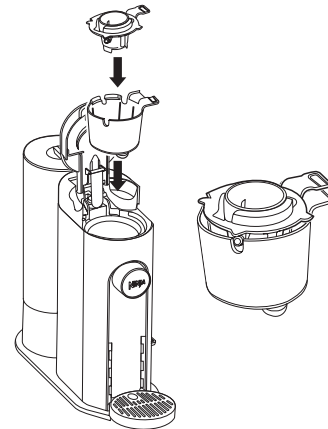

The images shown here are for illustrative purposes only and may be subject to change.

BREWING PODS CONT.

- 3** Press the coffee maker lid down firmly to pierce the pod and ensure that it is completely closed. There will be an audible click and some resistance when closing the handle as the needle punctures the pod.

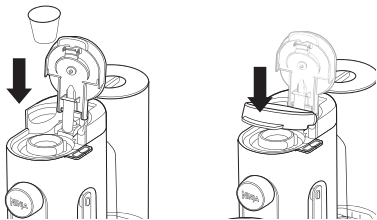

- 4** Place an empty vessel under the nozzle.

NOTE: Set the Adjustable Cup Tray to desired height by pulling the cup tray up and out for smaller vessels and to help prevent coffee splatter. The cup tray may be removed for brewing into taller and wider vessels.

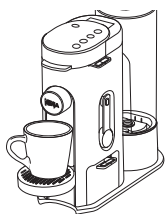

- 5** Press the Style Button and select either Classic, Rich, Over Ice, or Specialty brew.
- 6** Press the Size Button to toggle through and choose your desired size.
- 7** Press the Brew Button to start brewing. A confirmation beep will sound and the progress bar on the control panel will illuminate to indicate the status of the brew. When finished, the coffee maker will beep three times.
- 8** To cancel the brew at any time, press the Brew Button again or press the Power Button.

NOTE: The brewing cycle will begin then pause for a short period before resuming. This is to evenly saturate the coffee grounds. The progress bar is an indication of the total time remaining until the end of the brew.

NOTE: We recommend disposing of the used pod after it has cooled down following a brew to prevent any excess water retention in the brew basket.

MEASURING YOUR COFFEE GROUNDS

For best results, use the measurements on the Ninja Smart Scoop™ or in the chart to determine how much ground coffee to use for each brew size. The amount of ground coffee for each size will remain the same for any brew type you select. For example, if you select **10 oz.** and **Classic**, you will use the same amount of coffee grounds as if you were to select **10 oz. Rich** and **10 oz. Over Ice**.

NOTE: Adjust to your preferred taste. More scoops result in stronger coffee but slightly lower volumes, fewer scoops result in weaker coffee and slightly higher volumes. Decaf and finer grind coffees drain slower and may cause coffee to overflow the filter. If overflow occurs, we recommend one less scoop. We also recommend one less scoop for decaf. With some brands of coffee, the amount of grounds may need to be reduced to prevent overflow.

COFFEE MEASUREMENT CHART

Serving Size	Ninja Smart Scoop	Tablespoons
6 oz.	2-3 Scoops	2-3 Tablespoons
8 oz.		
10 oz.		
12 oz.		
14 oz.	3-5 Scoops	3-5 Tablespoons
18 oz.		
24 oz.	5-7 Scoops	5-7 Tablespoons
Specialty (4 oz.)	4 Scoops	4 Tablespoons

BREWING GROUND COFFEE

- 1** To prepare for brewing using ground coffee, open the coffee maker lid and ensure the brew basket is installed.

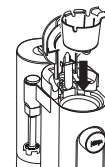

- 2** Place the Permanent Filter in the brew basket; the Permanent Filter is located in the Adapter Storage Bin on the right side of the coffee maker.

NOTE: DO NOT use a paper filter in this coffee maker.

NOTE: Ensure that the Ninja Pod Adapter is removed from brew basket before inserting the Permanent Filter.

NOTE: The adapter storage bin can be used for both Permanent Filter and Ninja Pod Adapter.

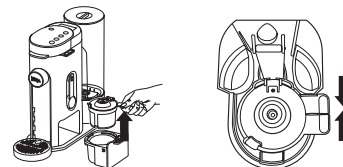

- 3** Follow the measurements on the Ninja Smart Scoop or in the Coffee Measurement Chart to fill the Permanent Filter.

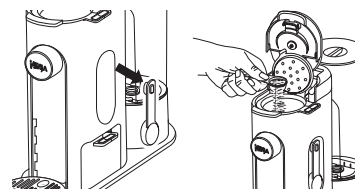

NOTE: DO NOT place ground coffee directly in the brew basket without the Permanent Filter installed.

The images shown here are for illustrative purposes only and may be subject to change.

- 4** Close the Permanent Filter lid and the coffee maker lid.

- 5** Place an empty vessel under the nozzle.



NOTE: Set the Adjustable Cup Tray to desired height for smaller vessels and to help prevent coffee splatter.

- 6** Press the Style Button and select either Classic, Rich, Over Ice, or Specialty brew. (not available on all models).
- 7** Press the Size Button to toggle through sizes.
- 8** Press the Brew Button to start brewing. A confirmation beep will sound and the progress bar on the control panel will illuminate to indicate the status of the brew. When finished, the coffee maker will beep three times.
- 9** To cancel the brew at any time, press the Brew Button again or press the Power Button.

NOTE: The brewing cycle will begin then pause for a short period before resuming. This process is used to evenly saturate the coffee grounds. This applies to all brew styles. The progress bar is an indication of the total time remaining until the end of the brew.

INTEGRATED FROTHER (NOT INCLUDED ON ALL MODELS)

INTEGRATED FROTHER

The Integrated Frother does not heat milk.

- 1 Add milk to your cup until it is about 1/3 full.
 - or cold froth, continue to Step 2.
 - For hot froth, microwave for 45-60 seconds.



- 2 Swing the arm of the frother toward the front of the coffee maker. Install the frother whisk by twisting it to the right.

CLEANING & MAINTENANCE

DISHWASHER-SAFE PARTS:

Brew basket, Permanent Filter, Ninja Pod Adapter, Water Reservoir, Frother Whisk, Nozzle, and Ninja Smart Scoop.

CLEANING THE FROTHER:

Clean the Frother Whisk after each use. Hand-wash thoroughly or wash in the dishwasher.

CLEANING THE WATER RESERVOIR

Empty the Water Reservoir and hand-wash or place in dishwasher. For a better clean, we recommend placing it in the bottom rack of the dishwasher standing upright with the opening facing downward.

CLEANING THE ADAPTER STORAGE BIN

Remove the Adapter Storage Bin from the unit and the adapter inside. Hand-wash thoroughly with warm, soapy water.

CLEANING THE NINJA POD ADAPTER

If brewing pods, first remove the used pods from the Ninja Pod Adapter. Then pinch the right tab of the handle and lift straight up to remove from the brew basket. Hand-wash the Ninja Pod Adapter and brew basket with warm, soapy water. To ensure that the needle in the Ninja Pod Adapter is free from any residual buildup, we recommend using a flat wire or plastic clip, such as a paper clip, to clean it out.

- 3 Hold the cup under the frother and submerge the whisk just below the surface of the milk. Press and hold the button on top of the frother and froth for 30-45 seconds.

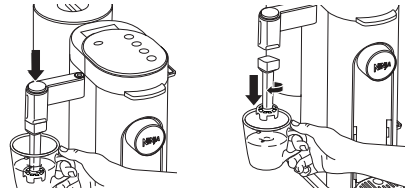

- 4 Remove the frother whisk by twisting it to the left. Keep your cup below the whisk while you carry it to your sink or dishwasher for easy cleaning.

WARNING: To avoid contact with steam and hot surfaces, **DO NOT** reach across top of coffee maker to froth.

CLEANING THE NOZZLE

Remove the nozzle by pinching the sides and pulling out of the coffee maker. Hand-wash thoroughly or wash in the dishwasher. We recommend checking and cleaning the nozzle periodically to ensure there is no built-up residue from brewed coffee which may cause overflow in the nozzle.

When reinstalling the nozzle, ensure that the nozzle is securely in place on the coffee maker.

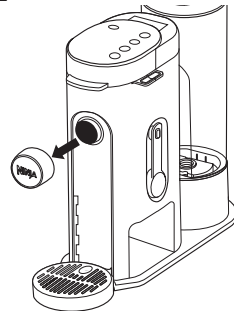

CLEANING THE PERMANENT FILTER

If brewing grounds, allow the coffee maker to cool. First remove the Permanent Filter by pinching both tabs of the Permanent Filter and brew basket handle and lift up to prevent dripping. Then open the Permanent Filter lid back until it is fixed in place to discard the used grounds. The showerhead on the Permanent Filter can also be removed by turning it counterclockwise and pulling it off the lid. To reinstall the showerhead, back on the Permanent Filter lid, line up the notches on the permanent Filter lid with the cutouts on the showerhead and turn clockwise. Hand-wash the permanent Filter, showerhead, and brew basket with warm soapy water.

CLEANING & DESCALING YOUR BREWING SYSTEM

The Intelligent Clean Cycle Indicator will automatically illuminate orange when a cleaning cycle is recommended for the coffee maker. The coffee maker will eventually need to be cleaned with a clean cycle. The clean cycle is used for descaling the coffee maker when calcium scale buildup is affecting the performance of the coffee maker and/or the flavor of your coffee.

NOTE: The clean cycle takes approximately 75 minutes.

BEFORE YOU BEGIN

You will need a large vessel that holds at least 56 oz. of water. We recommend using a 2 qt. or larger mixing bowl or saucepan. If you are unsure if you have a large enough vessel, fill the water reservoir to the MAX line and pour it into the desired vessel to ensure capacity.



TO CLEAN AND DESCALE YOUR NINJA SINGLE-SERVE COFFEE MAKER:

- 1 Insert either the Permanent Filter or Ninja Pod Adapter in the brew basket and close the lid. Ensure there are no grounds or pods inside the coffee maker.

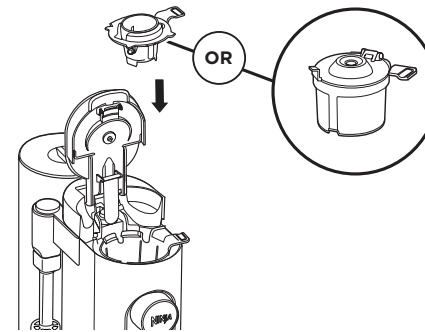

- 2 Remove the Adjustable Cup Tray by lifting up and out.

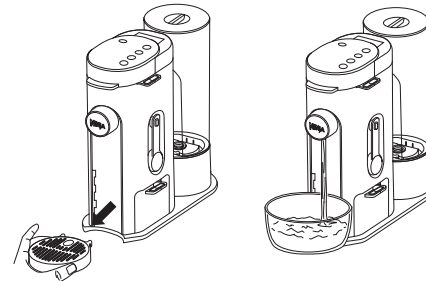

- 3 Place vessel beneath the nozzle.

NOTE: Ensure vessel can hold at least 56 oz. (MAX line) of water.

- 4 Fill the water reservoir with 16 oz. of white vinegar, then fill the rest of the reservoir with water up to, but not exceeding, the MAX line.

IMPORTANT: Only use white vinegar OR descale solution to product spec.

- 5 Once the water reservoir is filled with white vinegar and water mixture, press the CLEAN button.
- 6 Press the BREW button to begin the cleaning cycle. The clean cycle will take approximately 75 minutes. The coffee maker will deliver a small amount of cleaning solution to distribute through the system. It will then pause, deliver additional cleaning solution, and repeat this process for 75 minutes. The extended pauses allow for maximum cleaning and descaling.

IMPORTANT: If you cancel the clean cycle while it is running your coffee maker will not be properly descaled.

- 7 Upon completion, the coffee maker will beep and the Clean Cycle Indicator will turn off.

NOTE: To cancel the clean cycle, press the Power button or CLEAN button once. The coffee maker will beep and stop brewing through the cleaning mixture. Continue to follow the instructions starting at Step 4.

- 8 Empty the vessel and clean the water reservoir with warm, soapy water to remove any cleaning solution that could affect the flavor of your coffee.
- 9 Place the vessel back beneath the nozzle and fill the water reservoir with fresh water to the 24 oz. line.
- 10 Flush the system by running a water-only 24 oz. Classic brew.

The images shown here are for illustrative purposes only and may be subject to change.

TROUBLESHOOTING GUIDE

There's sediment in my coffee.

- This may be due to using finely ground coffee. To reduce the amount of sediment in the brewed coffee, use a slightly coarser grind.
- This may be due to using a damaged or old pod.

Over ice brew is not cold.

- Ensure your cup or travel mug is filled all the way to the top with ice cubes before brewing. Coffee maker will brew at elevated temperatures to lock in the best flavor, then the ice will cool the brewed coffee to the perfect temperature.

Coffee is too weak.

- For stronger coffee, use the Rich brew setting. For an even bolder flavor, you can add more coffee grounds to the filter. DO NOT exceed the maximum recommended amount of scoops when brewing a 24 oz. coffee.

Coffee is too strong.

- For milder coffee, use the Classic brew setting. For an even milder flavor, use fewer coffee grounds in the filter.

Brew cycle is too slow.

- The brew time will vary based on size and brew style. Larger size brews and Rich brews will take longer than smaller size brews and Classic brews. The progress bar on the control panel will indicate brew status.

Cup or travel mug overflowed.

- Refer to the Approximate Brew Volumes chart.

Brew Basket overflowed.

- The bottom of the brew basket or the nozzle may be clogged. If nozzle is clogged, refer to the CLEANING THE NOZZLE section. This can happen with finely ground coffee or too many coffee grounds in the filter. Medium-grind coffee is recommended.
- Decaf coffee grounds absorb water differently, so use fewer scoops when using decaf.

There is water left in the reservoir.

- When the reservoir is filled to a specific size and then that size is brewed, there will be some water left in the reservoir. This is normal to ensure the reservoir does not run dry and affect the performance of the pump and brew system.

Coffee maker is leaking.

- After removing the water reservoir, there may be a small amount of water in the reservoir valve. This can be easily removed with a dry cloth.
- If the leak is coming from above the brew basket, refer to "Brew Basket overflowed." above.
- If the leak is coming from below the brew basket, lift the coffee maker lid to engage the drip stop.
- If the leak is coming from behind the nozzle, refer to "CLEANING THE NOZZLE" section.
- If the leak is coming from the bottom of the coffee maker, contact a service center.

Intelligent Clean Cycle Indicator is illuminating orange.

- Run a clean cycle. If you have recently completed a clean cycle, you may need to run another cycle to remove additional mineral buildup that occurs naturally over time and is common in hard-water areas. Make sure you are using vinegar or a descaling solution and follow the cleaning instructions.

TROUBLESHOOTING GUIDE CONT.

Coffee Maker Buildup



If this appears on your control panel, this means either there are grounds built up inside the top needle or calcium scale buildup in the brew system.

- 1 Ensure that the top and bottom of the pod you are using are punctured.
 - a. If the pod wasn't punctured, place a new pod in the Ninja Pod Adapter and carefully apply pressure on the pod until the bottom of the pod is punctured by the bottom needle and then close the coffee maker lid.
 - b. If the new pod wasn't punctured, please contact a service center.
 - c. If the pod was punctured, go to step 2.
- 2 Check if there are any visible grounds inside the top and bottom needles.
 - a. If there are grounds visible in the top or bottom needle, use a flat wire or plastic clip, such as a paper clip, to clean the grounds out of the needle.
 - b. After cleaning out the needle, restart the system by powering off the coffee maker, turn it back on, and run a water-only 12 oz. brew to clear the system.
 - c. If there are no grounds present, go to Step 3.
- 3 There may be calcium scale buildup in the brew system and a clean cycle needs to be run immediately to remove the buildup. See 'Cleaning & Descaling Your Brewing System' for instructions.

TROUBLESHOOTING GUIDE CONT.

Coffee is splattering.

- Some splatter is normal. Use the cup tray when possible to reduce the distance between the cup and the coffee nozzle.
- Ensure the Ninja Pod Adapter is installed over the brew basket when brewing pods and that the nozzle is fully installed on the unit.

Water reservoir is unstable.

- Ensure the water reservoir is properly installed on the coffee maker and pressed down firmly into the water reservoir base.

Coffee keeps dripping after my brew.

- Coffee dripping after your brew means that the drip stop is not engaged. Once the brew is complete, open the coffee maker lid to pop up the brew basket in order to stop dripping.

There are multiple streams of coffee coming out of the nozzle.

- Multiple streams of coffee means that there is residual buildup in the nozzle causing overflow.
- Refer to the Cleaning & Maintenance section on how to clean the nozzle.

ERROR STATES

If any of these error states appear on the control panel, please contact a service center.

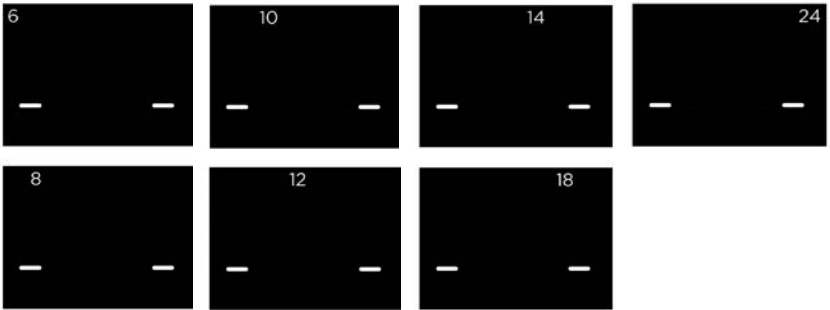

TECHNICAL SPECIFICATIONS

Voltage: 120V~, 60Hz
Power: 1500W
Water Reservoir
Capacity: 56 oz.



Please make sure to read the enclosed Ninja® Owner's Guide prior to using your unit.

NINJA®

SINGLE-SERVE

PODS & GROUNDS

SPECIALTY COFFEE MAKER

QUICK START GUIDE

WHAT'S IN THE BOX

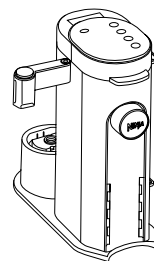

**NINJA PODS & GROUNDS
SPECIALTY COFFEE
MAKER**



ADAPTER STORAGE BIN



FROTHER WHISK



NINJA SMART SCOOP™
Use this to measure coffee grounds.



**56 OZ. REMOVABLE
WATER RESERVOIR**



ADJUSTABLE CUP TRAY



BREW BASKET

Comes fully installed in the brewer. It must always be inserted when brewing pods or grounds.



NINJA POD ADAPTER

Comes fully installed in the coffee maker. Ninja Pod Adapter must always be inserted in the brew basket when brewing pods.



PERMANENT FILTER

Located in the adapter storage on the right side of the unit. Permanent Filter must always be inserted in the brew basket when brewing grounds.

NOTE: In order to ensure the highest possible standard for refurbished items, all units are thoroughly inspected as part of the process. For this item, water may be used during the refurbishing process and so; you may notice some condensation in the water reservoir. It is recommended to rinse the water reservoir with fresh water prior to its first use.

•Accessory type and quantity may vary depending on the model.

•The images shown here are for illustrative purposes only and may be subject to change.

