

Shark[®]

V2950

OWNER'S GUIDE

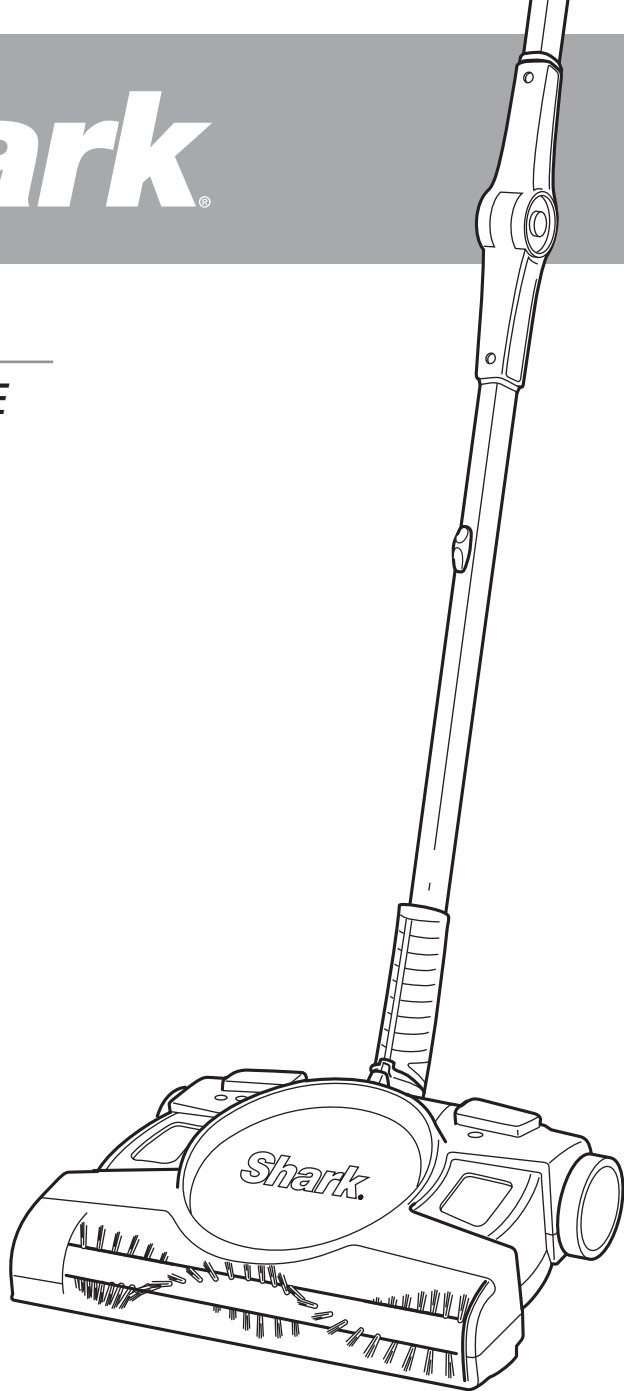

IMPORTANT SAFETY INSTRUCTIONS

For Household Use Only

READ ALL INSTRUCTIONS BEFORE USING YOUR SHARK® CORDLESS FLOOR AND CARPET SWEEPER.

WHEN USING YOUR SHARK® CORDLESS FLOOR AND CARPET SWEEPER, BASIC SAFETY PRECAUTIONS SHOULD ALWAYS BE OBSERVED, INCLUDING THE FOLLOWING:

WARNING: TO REDUCE THE RISK OF FIRE, ELECTRIC SHOCK OR INJURY:

- 1 Read all label, operational and marking instructions before using the appliance.
- 2 Use **ONLY** as described in this manual. Use only manufacturer's recommended attachments.
- 3 To reduce the risk of injury, **DO NOT** allow to be used as a toy. Close attention is necessary when used by or near children.
- 4 **DO NOT** use for any purpose other than described in this user's guide.
- 5 **DO NOT** use with damaged cord or plug. Do not use the cordless floor and carpet sweeper if it has been dropped, damaged, left outdoors, or dropped in water.
- 6 **DO NOT** abuse the charger cord. Never carry the charger or base by the cord or yank to disconnect from an outlet; instead grasp the charger and pull to disconnect.
- 7 Keep the charger cord away from heated surfaces.
- 8 **DO NOT** use the charger with an extension cord. Plug the charger directly into an electrical outlet. Use charger only in a standard electrical outlet.
- 9 **DO NOT** attempt to use the charger with any other product or attempt to charge this product with another charger. Use only the charger model **YLS0041-T110025** supplied with this cordless floor and carpet sweeper.
- 10 **DO NOT** charge this unit outdoors.
- 11 **DO NOT** use outdoors or on wet surfaces.
- 12 **DO NOT** handle plug or appliance with wet hands.
- 13 Use only on dry, indoor surfaces.
- 14 **DO NOT** put any object into openings. Do not use with brush roll blocked; keep free of fiber, lint, hair and anything that may prevent the brush roll from working.
- 15 Keep hair, loose clothing, fingers and all parts of body away from openings and moving parts.
- 16 **DO NOT** pick up anything that is burning or smoking, such as cigarettes, matches or hot ashes.
- 17 **DO NOT** use to pick up flammable or combustible liquids such as gasoline or use in areas where they may be present.
- 18 **DO NOT** attempt to change accessories while the unit is running.
- 19 **DO NOT** use the cordless floor and carpet sweeper without the dust cup in place.
- 20 Use extra care when cleaning on stairs.
- 21 Store the cordless floor and carpet sweeper indoors. Store after use to prevent accidents.
- 22 Leaks from battery cells can occur under extreme conditions. If the liquid, which is 20-35% solution of potassium hydroxide, gets on the skin - wash immediately with soap and water or neutralize with a mild acid such as lemon juice or vinegar. If the liquid gets into the eyes, flush them immediately with clean water for a minimum of 10 minutes and seek medical attention.
- 23 This product includes rechargeable nickel metal hydride batteries. Batteries must be recycled or disposed of properly. Do not incinerate the batteries or expose to high temperatures as they may explode.
- 24 The cordless floor and carpet sweeper must be disconnected from the power supply when removing the battery.
- 25 To reduce the risk of electrical shock, do not put the charger and sweeper body in water or other liquid. Do not place or store the appliance where it can fall or be pulled into a tub or sink.

**TO MAXIMIZE THE LIFE OF YOUR
NI-MH BATTERIES:**

- 1 Charge for 7 hours before initial use. Failure to do so will reduce the product's battery life significantly.
- 2 For best battery performance, remove the charging adapter from the unit after the charging period has completed.
- 3 Do not store the unit with the charging adapter attached and plugged in.
- 4 For maximum battery life, only recharge the unit when the batteries are close to fully discharged. It is best to fully discharge the batteries at least once a month.
- 5 **DO NOT** store in areas of high temperature or humidity.
- 6 After 3 months of non-use, the product should be fully discharged and then recharged to maximize battery power.
- 7 Ni-MH batteries have a long useful life but at some time they will need to be replaced. **Contact a service center.**

! **NOTE:** The On/Off switch must be in the "Off" position in order to charge the unit. If the charging indicator does not light, press the On/Off button once.

Warning: Changes or modifications to this unit not expressly approved by the party responsible for compliance could void the user's authority to operate the equipment.

Note: This equipment has been tested and found to comply with the limits for a Class B digital device, pursuant to Part 15 of the FCC Rules. These limits are designed to provide reasonable protection against harmful interference in a residential installation. This equipment generates, uses and can radiate radio frequency energy and, if not installed and used in accordance with the instructions, may cause harmful interference to radio communications.

However, there is no guarantee that interference will not occur in a particular installation. If this equipment does cause harmful interference to radio or television reception, which can be determined by turning the equipment off and on, the user is encouraged to try to correct the interference by one or more of the following measures:

- Reorient or relocate the receiving antenna.
- Increase the separation between the equipment and receiver.
- Connect the equipment into an outlet on a circuit different from that to which the receiver is connected.
- Consult the dealer or an experienced radio/TV technician for help.

This device complies with Part 15 of the FCC Rules. Operation is subject to the following two conditions: (1) This device may not cause harmful interference, and (2) this device must accept any interference received, including interference that may cause undesired operation.

SAVE THESE INSTRUCTIONS

QUICK START

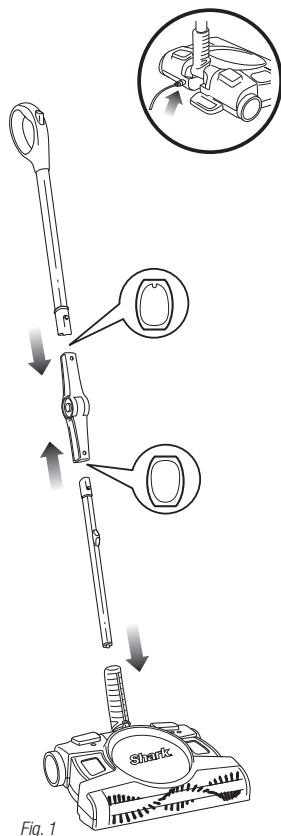

IMPORTANT: Before you can start using your new cordless floor and carpet sweeper, you'll need to charge it for 7 hours.

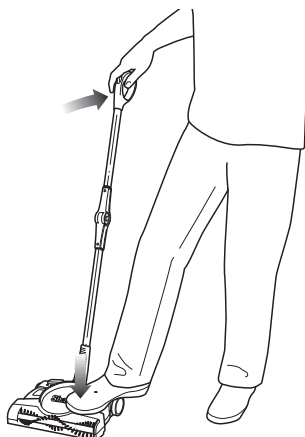

Fig. 2

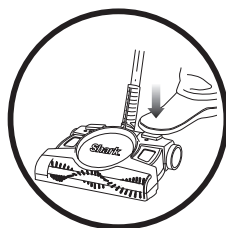

Fig. 3

ASSEMBLE

- 1 Assemble the upper and lower handle into the elbow joint to form the Shark® Backsaver™ folding handle. Then insert it into the base of your cordless floor and carpet sweeper. (fig. 1)

CLEAN

- 2 Pull back on the handle and press lightly on the body of the unit with your foot to engage the steering. (fig. 2)
- 3 Using your foot, press the On/Off button and push your cordless floor and carpet sweeper forward over the surface you wish to clean. (fig. 3)
- 4 Press the speed button on the right with your foot to change the speeds. One light indicates the speed optimized to clean bare floors and two lights indicate the speed optimized to clean carpets and larger debris on bare floors.

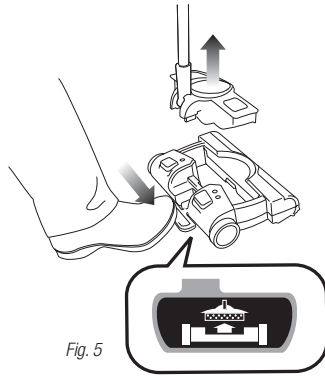
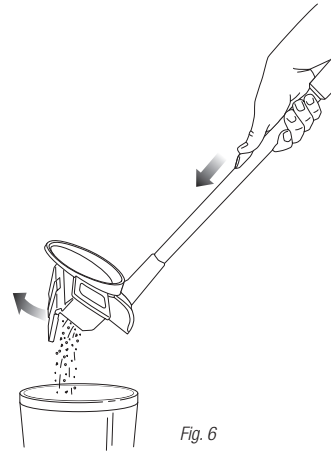
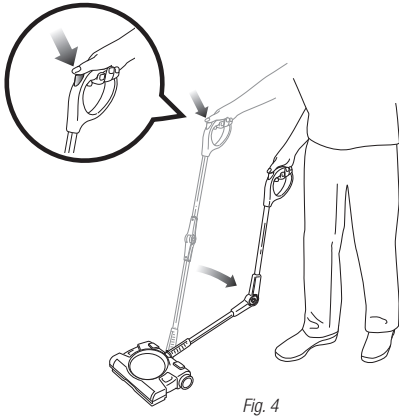

EMPTY

- 5 The Shark® Backsaver™ folding handle makes cleaning under furniture a breeze. Just press the button on the handle with your thumb to engage the Shark® Backsaver™ function. (fig. 4)
- 6 When you're finished cleaning, empty the No-Touch dust cup. Simply press the dust cup release pedal and lift out the dust cup. (fig. 5)
- 7 Over a trash can, empty the dust cup by pressing the bottom-empty button on the lower portion of the handle. When it's empty, gently snap the No-Touch dust cup back into place. (fig. 6)

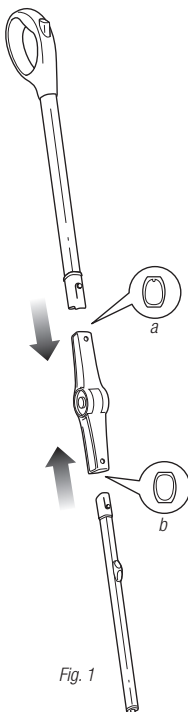
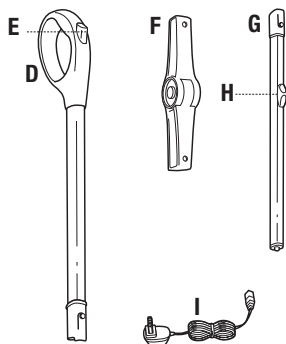
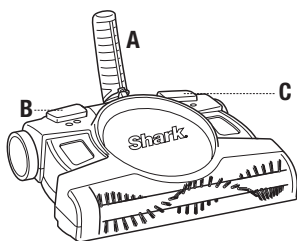

Fig. 1

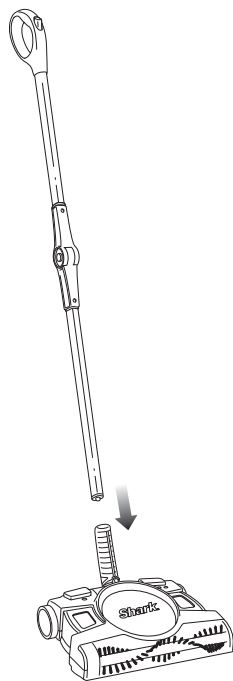

Fig. 2

COMPONENTS:

- A** Floor and Carpet Sweeper Base
- B** Speed Control Button
- C** On/Off Button
- D** Upper Pole with Handle
- E** Backsaver™ Release Button
- F** Shark® Backsaver™ Joint
- G** Lower Pole
- H** Dust Cup Empty Lever
- I** Charging Adapter

Model Number: V2950 32

Voltage: 7.2 V

ASSEMBLY OF YOUR FLOOR AND CARPET SWEEPER:

- 1** Slide the upper pole (the tube with the handle) into the end of the Shark® Backsaver™ joint that has a small notch in it (**a**). Then slide the lower pole into the other end of the joint (**b**). Push it in until it clicks into place. (**fig. 1**)

- 2** Insert the Shark® Backsaver™ folding handle you just assembled into the base. You should hear the locking tab click into place. (**fig. 2**)

⚠ IMPORTANT: You must charge the batteries for 7 hours before using the floor and carpet sweeper for the first time. See page 12 for instructions on charging your unit.

Accessory type and quantity may vary depending on the model.

USING YOUR CORDLESS FLOOR AND CARPET SWEEPER

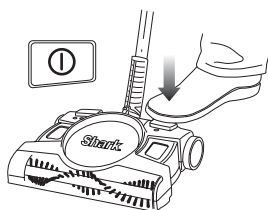

Fig. 3

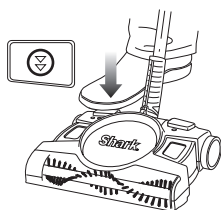

Fig. 4

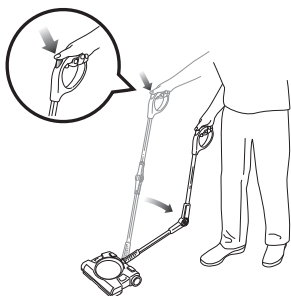

Fig. 5

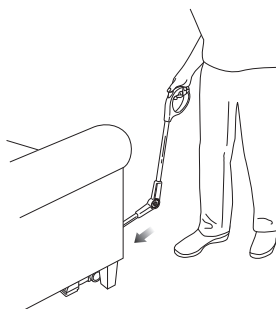



Fig. 6

 If the brush roll stops moving, it's probably due to the anti-jam feature. This feature protects the motor from becoming overheated. If the brush becomes overloaded, it will stop turning and both speed indicator lights will stay on. Turn off your unit by pressing the On/Off button once. Then remove the brush roll cover from the floor and carpet sweeper base and remove any hair or fiber that may be on the brush roll. Wait for 10 seconds to let your unit cool down. Now press the On/Off button again and you're ready to resume cleaning!

See page 13 for further instructions on removing or cleaning the brush roll.

- 1 Press the On/Off button to start the floor and carpet sweeper. When finished cleaning, press the On/Off button again to turn the unit off. (fig. 3)
- 2 You can adjust the speed of the brush roll to suit the floors that you are cleaning. Press the

button on the right (opposite the On/Off button) to switch between speeds. One light indicates the speed optimized to clean bare floors and two lights indicate the speed optimized to clean carpets and larger debris on bare floors. (fig. 4)

- 3 To clean under furniture, use the Shark® Backsaver™ folding handle. Press the handle release button and apply a bit of pressure to bend the handle forward. (fig. 5) The Shark® Backsaver™ joint will release from the locked position to reach messes under furniture. (fig. 6)

The image shown here is for illustrative purposes only and may be subject to change.

CHARGING YOUR CORDLESS FLOOR AND CARPET SWEEPER

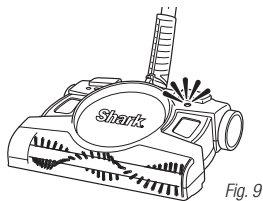
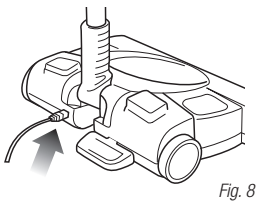
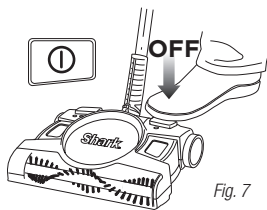

- 1 Always make sure that the unit is turned off. (fig. 7)
- 2 Insert the charger plug into the hole on the back of the floor and carpet sweeper base. (fig. 8) Plug the charger into a wall outlet. The light next to the On/Off button will illuminate when the unit is charging. If the unit is plugged in and the light is not illuminated, press the On/Off button once. The

light should now be illuminated indicating that the unit is charging. The light will turn off once the charge is completed. (fig. 9)

- 3 Let the battery recharge for 7 hours. Your cordless floor and carpet sweeper is powered by Ni-MH batteries that need this time to build up their charge.
- 4 For best battery performance, remove the charging adapter

from the unit after the charging period has completed. Storing the unit with the adapter attached and plugged in will reduce battery life.

⚠ IMPORTANT: Although many adapters look similar, it's important to use only the adapter that came with your floor and carpet sweeper (XA2950).

EMPTYING THE DUST CUP

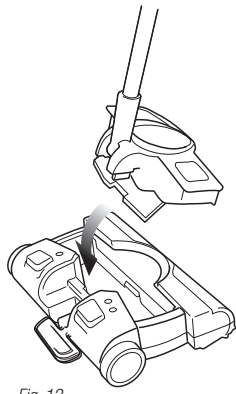
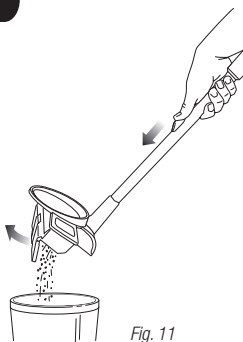
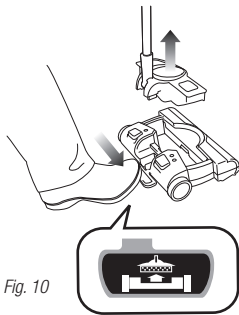

- 1 Press the dust cup release pedal on the floor and carpet sweeper base to remove the No-Touch dust cup. (fig. 10)
- 2 Hold the dust cup over a trash can and push the bottom-empty button located on the lower portion of the handle. The trap door will spring open and release the debris into the trash can. (fig. 11)

- 3 To re-insert the dust cup, position it over the floor and carpet sweeper base and press down gently until it snaps into place. (fig. 12)

💡 For easy insertion into the base, tip the dust cup slightly forward.

TROUBLESHOOTING GUIDE & REPLACEMENT PARTS

PROBLEM	POSSIBLE REASONS AND SUGGESTED SOLUTION
The cordless floor and carpet sweeper will not operate	<p>Batteries need to be recharged.</p> <p>Batteries are dead and need to be replaced.</p> <p>There is no power in the electrical outlet being used. Try to charge using a different outlet.</p> <p>Ensure the wire terminal connectors on the battery pack are securely attached.</p> <p>Clear any obstruction from the rotating brush.</p> <p>If your unit still doesn't work, Contact a Service center.</p>
The cordless floor and carpet sweeper will not pick up	<p>Empty the dust container.</p> <p>Recharge the battery</p>
Dust is escaping from the cordless floor and carpet sweeper	<p>Empty the dust container.</p>
Rotating brush will not pick up	<p>Check for and remove any excessive material on the brush roll or in the bottom of the unit.</p> <p>Empty the dust container.</p>
The cordless floor and carpet sweeper will not charge	<p>Press the power button once to turn the unit "OFF".</p> <p>There is no power in the electrical outlet being used. Try to charge using a different outlet.</p> <p>Ensure the wire terminal connectors on the battery pack are securely attached.</p> <p>Charging adapter may not be working. Contact a Service Center.</p> <p>Batteries are dead and need to be replaced</p>

