

Please read this manual carefully before operating your unit and retain for future reference.

804106497

Safety Information

Notice for customers in the United States of America

Supplier's Declaration of Conformity

Trade Name: SONY
Model: XBR-85X81CH / XBR-85X80CH / XBR-85X800H / XBR-75X81CH / XBR-75X80CH / XBR-75X800H / XBR-65X81CH / XBR-65X80CH / XBR-65X800H / XBR-55X81CH / XBR-55X80CH / XBR-55X800H / XBR-49X800H / XBR-43X800H

FCC Related Information

This equipment has been tested and found to comply with the limits for a Class B digital device, pursuant to Part 15 of the FCC Rules. These limits are designed to provide reasonable protection against harmful interference in a residential installation. This equipment generates, uses and can radiate radio frequency energy and, if not installed and used in accordance with the instructions, may cause harmful interference to radio communications. However, there is no guarantee that interference will not occur in a particular installation. If this equipment does cause harmful interference to radio or television reception, which can be determined by turning the equipment off and on, the user is encouraged to try to correct the interference by one or more of the following measures:

- Reorient or relocate the receiving antenna.
- Increase the separation between the equipment and receiver.
- Connect the equipment into an outlet on a circuit different from that to which the receiver is connected.
- Consult the dealer or an experienced radio/TV technician for help.

Pursuant to FCC regulations, you are cautioned that any changes or modifications not expressly approved in this manual could void your authority to operate this equipment.

Safety and Regulatory

5 GHz bands are restricted to indoor operations only.

Notice for customers in the United States

This equipment complies with FCC/IC radiation exposure limits set forth for an uncontrolled environment and meets the FCC radio frequency (RF) Exposure Guidelines and R55-102 of the IC radio frequency (RF) Exposure rules. This equipment should be installed and operated keeping the radiator at least 20 cm or more away from person's body (excluding extremities: hands, wrists, feet and ankles).

This device and its antenna(s) must not be co-located or operating with any other antenna or transmitter except Grant condition.

NOTE ON AC ADAPTER (models with supplied AC adapter only)

WARNING

To reduce the risk of fire or electric shock, do not expose this apparatus to rain or moisture. To prevent fire or shock hazard, do not place objects filled with liquids, such as vases, on the apparatus. Do not install this equipment in a confined space, such as a bookshelf or similar unit.

- Please ensure that the AC power outlet is installed near the equipment and shall be easily accessible.
- Be sure to use the supplied AC adapter and AC power cord. Otherwise it may cause a malfunction.
- Connect the AC adapter to an easily accessible AC power outlet.

- Do not coil the AC power cord around the AC adapter. The core wire may be cut and/or it may cause a malfunction of the TV.
- Do not touch the AC adapter with wet hands.

- If you notice an abnormality in the AC adapter, disconnect it from the AC power outlet immediately.
- The set is not disconnected from the AC source as long as it is connected to the AC power outlet, even if the set itself has been turned off.
- As the AC adapter will become warm when it is used for a long time, you may feel hot when touching it by hand.

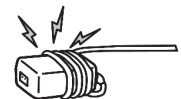

Compatible Wall-Mount Bracket Information (not supplied)

Use the following Sony Wall-Mount Bracket with your TV model.

	Sony TV Model No.
	XBR-75X800H / 65X800H / 55X800H
Sony Wall-Mount Bracket Model No.	SU-WL855*1

Use with other Wall-Mount Brackets*2 may cause instability and could result in property damage or injury.

*1 Only on limited region/country/TV model.

*2 For instructions on using the Wall-Mount bracket with your TV please contact a service center.

Before setting up your TV

Some TV models are packaged with a detached Table-Top Stand so you can mount your TV to a wall right away. See "Installing the TV to the Wall" if you want to mount the TV to a wall. If you are not mounting the TV to a wall, you will need to attach the Table-Top Stand. You will need a Phillips screwdriver (not supplied) and the supplied screws to complete the task, refer to the Setup Guide.

- Be sure to consider the following while setting up your TV:
 - Disconnect all cables when carrying the TV.
 - Carry the TV with the adequate number of people; larger size TVs require two or more people (three or more people for XBR-85X81CH / 85X80CH / 85X800H).
 - Correct hand placement while carrying the TV is very important for safety and to avoid damage.

XBR-85X81CH / 85X80CH / 85X800H

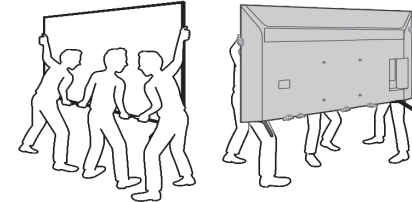

XBR-75X81CH / 75X80CH / 75X800H / 65X81CH / 65X80CH / 65X800H / 55X81CH / 55X80CH / 55X800H / 49X800H / 43X800H

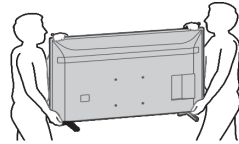

- Ensure your TV has adequate ventilation, refer to the safety documentation.
- For best picture quality, do not expose the screen to direct illumination or sunlight.
- Avoid installing the TV in a room with reflective wall and floor materials.
- Avoid moving the TV from a cold area to a warm area. Sudden room temperature changes may cause moisture condensation. This may cause the TV to show poor picture and/or poor color. Should this occur, allow moisture to evaporate completely before powering the TV on.

Securing the TV

- Sony strongly recommends taking measures to prevent the TV from toppling over. Unsecured TVs may topple and result in property damage, serious bodily injury or even death.



Preventing the TV from Toppling

- Secure the TV to a wall and/or Stand.
- Do not allow children to play or climb on furniture and TV sets.
- Avoid placing or hanging items on the TV.
- Never install the TV on:
 - slippery, unstable and/or uneven surfaces.
 - furniture that can easily be used as steps, such as a chest of drawers.
- Install the TV where it cannot be pulled, pushed, or knocked over.
- Install the TV so that the TV's Table-Top Stand does not protrude out from the Stand (not supplied). If the Table-Top Stand protrudes out from the Stand, it may cause TV set to topple over, fall down, and cause personal injury or damage to the TV.



- Route all AC power cords and connecting cables so that they are not accessible to curious children.

Recommended Measures to Secure the TV

Consider the following measures when securing your TV to a Stand (not supplied).

- Secure the Stand for the TV. Make sure the Stand can adequately support the weight of the TV. Use two angle braces (not supplied) to secure the Stand. For each angle brace use the appropriate hardware to:

- Attach one side of the angle brace to the wall stud.
- Attach the other side to the Stand.

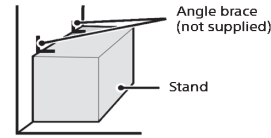

- Secure the TV to the Stand. Use the optional hardware listed as follows (not supplied):
 - M6 machine screws (screwed into the TV's rear cover).
 - A screw or similar (attach it to the Stand).
 - Rope or chain (strong enough to support the weight of the TV). Make sure that there is no excess slack in the rope or chain.

Remote Control and TV

The remote control shape, location, availability and function of remote control buttons may vary depending on your region/country/TV model.

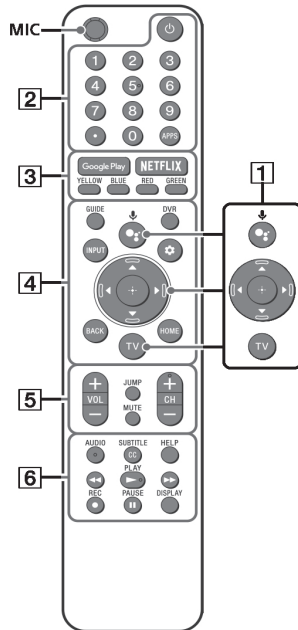

(Batteries not supplied)

- *: (The Google Assistant) /

↓ (Microphone): Use the Google Assistant*1*2 or voice search*2. For hints on how to control your TV press *: (the Google Assistant) / ↓ (Microphone) button and speak the phrase "voice hints".*1

▲/▼/◀/▶/⊕: On screen menu navigation and selection.

TV: Display TV channel list or switch to input.

- Ⓜ (TV standby)

Number buttons

● (dot)

APPS: Display a list of installed apps.

- Google Play / NETFLIX*1 / Color buttons

The remote control vary depend of model: The buttons on remote control may have a different name or location than the remote control shows in this manual.

- If you are having problems with the remote control, reinsert or replace your batteries and make sure that they are correctly inserted.

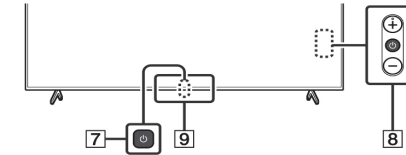

- Ⓜ (Power) (except XBR-49X800H / 43X800H)

Note: The images shown here are for illustrative purposes only and may be subject to change. The actual menus may vary depending on the model.

Installing the TV to the Wall

Using the optional Wall-Mount Bracket (SU-WL855 only)* (not supplied)

To Customers:

For product protection and safety reasons, it is strongly recommends that installation of your TV be performed by it is dealers or licensed contractors. Do not attempt to install it yourself.

Wall-Mount Bracket Installation Information

This TV's instruction manual only provides the steps to prepare the TV for Wall-Mount installation before it is installed on the wall. For instructions on Wall-Mount Bracket installation, see the Installation Information (Wall-Mount Bracket) on the it is Customer

Preparing for Wall-Mount Installation

You can use the Wall-Mount Bracket SU-WL855 (not supplied) to install the TV to the wall. Make sure to attach the Table-Top Stand before installing the TV to the wall by referring to the Setup Guide (except XBR-49X800H / 43X800H).

- Prepare the TV for the Wall-Mount Bracket before making cable connections.
- Follow the instruction guide provided with the Wall-Mount Bracket for your model. Sufficient expertise is required in installing this TV, especially to determine the strength of the wall for withstanding the TV's weight.
- Be sure to entrust the attachment of this product to the wall to it is dealers or licensed contractors and pay adequate attention to safety during the installation. it is not liable for any damage or injury caused by mishandling or improper installation.
- The screws for Wall-Mount Bracket are not supplied.
- The length of the screw for Wall-Mount Bracket differs depending on the Wall-Mount Bracket thickness. Please refer to below illustration.

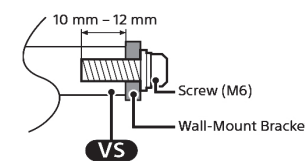

- Be sure to store the unused screws and Table-Top Stand in a safe place until you are ready to attach the Table-Top Stand. Keep the screws away from small children.

* Only on limited region/country/TV model.

- Ⓜ (Power)/+/- (XBR-49X800H / 43X800H only)

Remote Control sensor / Light sensor / LED

- *1 Only on limited region/country/TV model/ language.
- *2 The Google Assistant or voice search requires an Internet connection.
- *3 [Cable/Satellite box setup] setting is required.
- *4 Accessibility shortcut is available by pressing and holding MUTE.

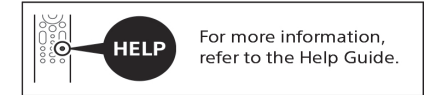

Note

- Read the supplied Safety Booklet for additional safety information.

Remove the screws from the rear of the TV.

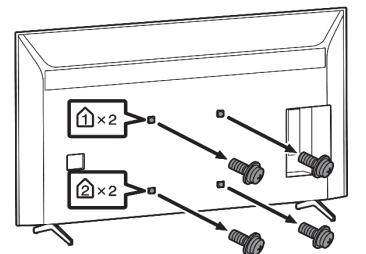

Using the optional Wall-Mount Bracket (Except SU-WL855) (not supplied)

This TV's instruction manual only provides the steps to prepare the TV for Wall-Mount installation before it is installed on the wall.

Your TV can be mounted to a wall using a suitable Wall-Mount Bracket (not supplied). If the Table-Top Stand is attached to the TV, the TV may require detaching the Table-Top Stand; see "Detaching the Table-Top Stand from the TV". Prepare the TV for the Wall-Mount Bracket before making cable connections.

For product protection and safety reasons, it is strongly recommends that installation of your TV on the wall be performed by qualified professionals. Do not attempt to install it yourself.

- Follow the instruction guide provided with the Wall-Mount Bracket for your model. Sufficient expertise is required in installing this TV, especially to determine the strength of the wall for withstanding the TV's weight.
- The screws for Wall-Mount Bracket are not supplied.
- The length of the screw for Wall-Mount Bracket differs depending on the Wall-Mount Bracket thickness. Please refer to below illustration.

XBR-85X81CH / 85X80CH / 85X800H / 75X81CH / 75X80CH / 75X800H / 65X81CH / 65X80CH / 65X800H / 55X81CH / 55X80CH / 55X800H only

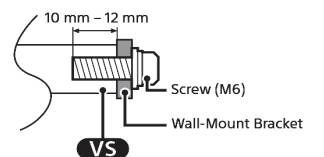

SONY® Setup Guide



1

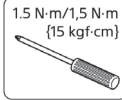
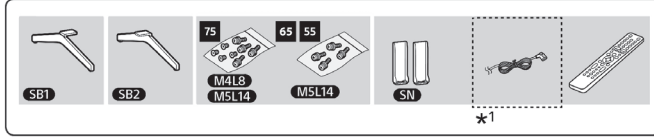

Tools
not supplied

2

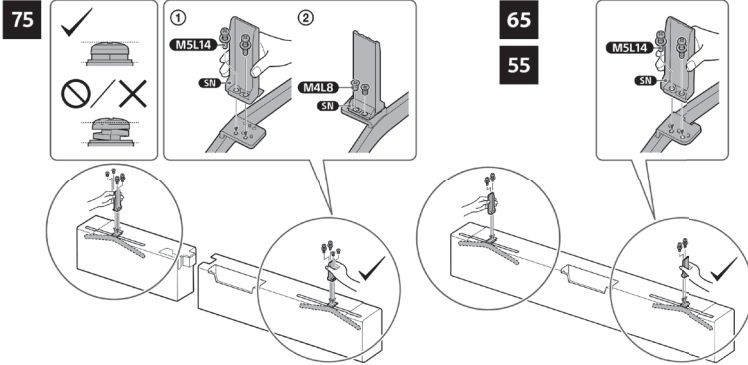

3

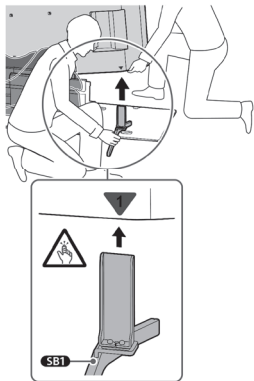

4

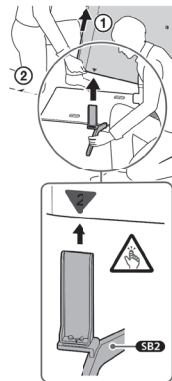

5

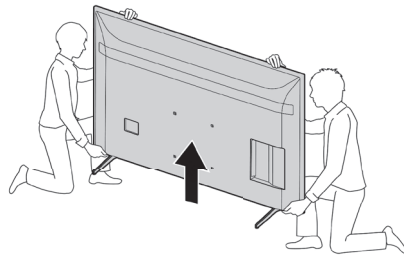

804006497

6

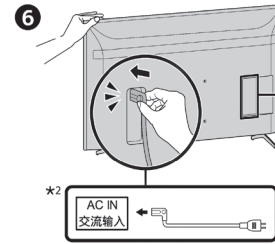

The cables mentioned in
this guide is not supplied
with your unit.

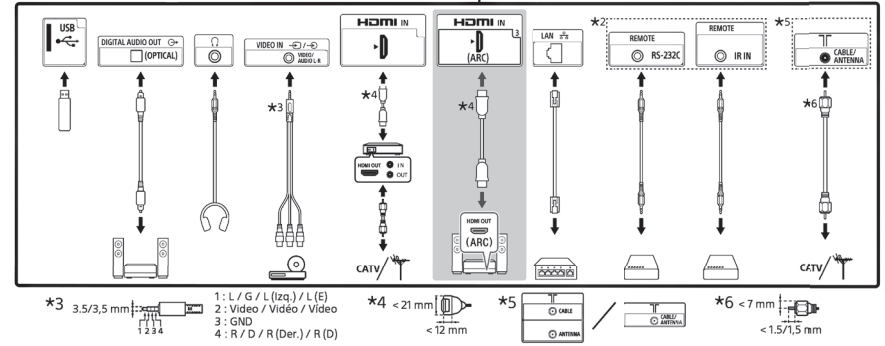

7

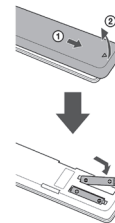

(Batteries not supplied)

8

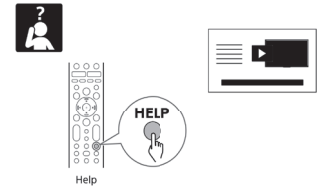
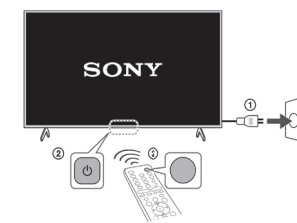

The remote control varies depending on the model: The buttons on the remote control may have a different name or location than the remote control shows in this manual.

The image shown here is for illustrative purposes only and may be subject to change. The actual number of ports and their locations may vary depending on the model.



804006497



PRINTED IN MEXICO
SC.26-03-2021
SHNMDL: XBR65X81CH_B
OBPN: 5-013-153-12(1)
Elbrd:J.E. / 1P