

**IMPORTANT SAFETY INSTRUCTIONS**

**⚠ WARNING** To reduce the risk of fire, electrical shock, injury to persons, or damage when using the air conditioner, follow basic precautions, including the following:

- Read all of the instructions before using this appliance.
- Plug into a grounded 3 prong outlet.
- Do not remove ground prong.
- Do not use an adapter.
- Do not use an extension cord.
- Do not operate the air conditioner if it has a damaged cord or plug, if it is not working properly, or if it has been damaged or dropped.
- The air conditioner should be serviced only by qualified service personnel. Contact a service center.
- Disconnect power before servicing.
- Disconnect power before cleaning.
- **NOTE:** Turning off power by pressing the Power button does NOT disconnect the appliance from the power supply.
- Do not install or use the air conditioner in any area where the atmosphere contains combustible gases or where the atmosphere is contaminated. Avoid any chemicals coming in contact with your air conditioner.
- Do not store anything directly on top of the air conditioner.
- Use two or more people to move and install air conditioner.
- Never operate the air conditioner without the filters in place.
- Do not use the air conditioner near a bathtub, shower or wash basin or other wet area.

**⚠ WARNING Risk of Fire or Explosion. This unit contains flammable refrigerant. Additional safety precautions must be followed.**

- Do not use means to accelerate the defrosting process or to clean, other than those recommended by the manufacturer.
- The appliance shall be stored in a room without continuously operating ignition sources (for example: open flames, an operating gas appliance or an operating electric heater).
- Do not pierce or burn refrigerant tubing. Be aware that refrigerants may not contain an odor.
- Keep ventilation openings clear of obstruction.
- When handling, installing, and operating the appliance, care should be taken to avoid damage to the refrigerant tubing.
- Do not drill holes in the unit.
- Maintenance, cleaning, and service should only be performed by technicians properly trained and qualified in the use of flammable refrigerants.
- GE Appliances does not support any servicing of the air conditioner.
- Dispose of air conditioner in accordance with Federal and Local Regulations. Flammable refrigerants require special disposal procedures. Contact your local authorities for the environmentally safe disposal of your air conditioner.

**⚠ WARNING How to Insert the Batteries (not supplied) in the Remote Control**

- Remove the battery cover by sliding it according to the arrow direction.
- Insert new batteries, making sure that the (+) and (-) of battery are installed correctly.
- Reattach the cover by sliding it back into position.

**NOTES:**

- Use 2 "AAA" (1.5 volt) alkaline batteries. Do not use rechargeable batteries
- Remove the batteries from the remote control if the system is not going to be used for a long time.
- Do not mix old and new batteries. Do not mix alkaline, standard (carbon-zinc) or rechargeable (ni-cad, ni-mh, etc) batteries.

**⚠ WARNING Caution for Ingestion. The battery may cause suffocation if swallowed by children.**

**READ AND SAVE THESE INSTRUCTIONS**

**Controls**

Features and appearance will vary. Lights next to the buttons on the air conditioner control panel indicate the selected settings.

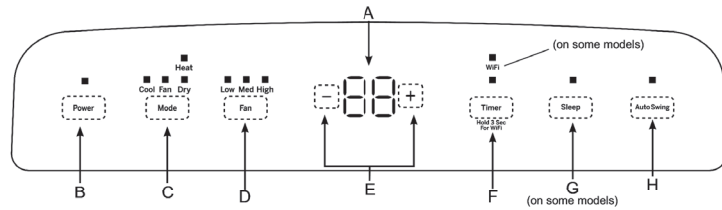

- A. Control Panel Display**  
Displays the Set Temperature in degrees Fahrenheit or degrees Celsius, or the hours remaining in a Time Delay.
- B. Power Button**  
Turns the air conditioner on or off.  
**NOTE:** Turning off power by pressing the Power button does NOT disconnect the appliance from the power supply.  
• Press the Power button. The Power indicator will illuminate and the AC will turn on.
- C. Mode Button**  
Press the Mode button to toggle among the operating options. The corresponding indicator will illuminate:  
**Cool** – Cools the room to the set temperature  
**Fan** – Circulates the air in the room without cooling  
**Dry** – Reduces the humidity in the room  
**Heat** (on some models) - Heats the room to the set temperature
- D. Fan Speed Button**  
The fan speed can be adjusted from Low, Medium, to High speed when the air conditioner is in operation.  
**NOTE:** The fan speed cannot be adjusted when the unit is in Dry or Sleep modes.  
• Press the Fan speed button to toggle among the three speeds. The corresponding fan speed indicator will illuminate.

- E. Timer / Temperature Set Controls**  
Adjusts the Temperature or Hours in Time Delay.  
**To Set the Temperature:**  
1. Press the Mode button until the Cool mode is selected.  
2. Press the Up Arrow or Down Arrow buttons to select the desired temperature.  
**NOTE:** The temperature cannot be set when the air conditioner is in either Fan or Dry mode.  
**A. NOTE:** The Up Arrow and Down Arrow buttons, when pressed at the same time, allow you to select between displaying the temperature in °F or °C.

**NOTE:** The image shown here is for illustrative purposes only and may be subject to change. The actual descriptions of control panel and their locations may vary, depending on the model.

The display will always default to show the room temperature. When the air conditioner is turned on, it will automatically start in the last mode and fan settings selected.

**Cool Mode**

Use the Cool mode for cooling.  
To set the Cool mode:  
1. Press the MODE button until the Cool indicator light is lit.  
2. Press the FAN button to set HIGH, MEDIUM, or LOW fan speed.  
3. Press + or - to set the desired temperature.  
After settings have been made, the display will change back to show the room temperature.  
The temperature control is used to maintain the room temperature. The compressor will cycle on and off to keep the room at the set level of comfort. Set the temperature control at a lower number and the indoor air will become cooler. Set the temperature control at a higher number and the indoor air will become warmer.

**Dry Mode—Dehumidification**  
Use the Dry mode to provide dehumidification only. The fan will run at a fixed speed at this setting, so a fan speed cannot be set. Keep windows and doors closed for the best dehumidifying effects.  
**To set the Dry mode:**  
• Press the MODE button until the Dry indicator light is lit.

**FAN Mode**  
Use the FAN mode to provide air circulation and filtering without cooling.  
**To set the FAN mode:**  
• Press the FAN button until the desired indicator light for high, medium, or low fan speed is lit.

**HEAT Mode (for Heat/Cool models only)**  
Use the Heat mode at Low, Med, or High Speed for heating. Use the Temperature Increase (+) /Decrease (-) buttons to set the desired temperature.

**Power Outage Recovery Feature**  
In the case of a power outage or interruption, the unit will automatically re-start in the settings last used after the power is restored.

**F. Timer Button**  
Program a time from (1-hour to 24-hours) for the air conditioner to turn Off or On. When a Time Delay is programmed, the Timer indicator light will illuminate.  
**While the air conditioner is operating:**  
1. Press the Timer button.  
2. Press the Up/Down Arrow buttons to select the number of hours you want the air conditioner to continue to operate before turning Off.  
**NOTE:** Wait approximately 5 seconds for the Turn-Off time to be saved.

**While the air conditioner is off:**  
1. Press the Timer button.  
2. Press the Up/Down Arrow buttons to select the number of hours you want the air conditioner to remain off before turning On.  
**NOTE:** Wait approximately 5 seconds for the Turn-On time to be saved.

**To cancel the timer:**  
• Press the Timer button once, the hours remaining will flash, press the timer button again and the timer will be canceled.

**To turn on WiFi:** (on some models)  
1. Press and hold the Timer button for 3 seconds to turn on the WiFi function.  
Refer to the "WiFi Set up" section for more information on how to connect your Portable AC to your router and installing the HQ App.

**G. Sleep**  
Press the Sleep button to activate sleep mode, press again to cancel.  
The fan speed will automatically change to low speed and cannot be adjusted. The temperature will rise after 2 and 4 hours to ensure your comfort overnight.

**H. Auto Swing**  
The louver on your portable air conditioner will open automatically when you turn it on (do not pry it open or push it shut).  
1. When your AC is turned on, the louver will swing up and down.  
2. You can press the Auto Swing button to fix the louver in your desired position

**NOTE:** If the air conditioner is off and is then turned on while set to Cool, it will take approximately 3 minutes for the compressor to start and cooling to begin.  
**Cooling Descriptions**  
**For Normal Cooling**—Select the Cool mode and HIGH, MEDIUM, or LOW fan speed with a middle set temperature.  
**For Maximum Cooling**—Select the Cool mode and HIGH fan speed with a lower set temperature.  
**For Quieter & Nighttime Cooling**—Select the Cool mode and LOW fan speed with a middle set temperature.  
**NOTE:** If you switch from Cool, Dry or Heat mode setting to OFF, wait 3 minutes before restarting.

In the Dry mode, a set temperature will not be displayed. After Dry mode has been set, the display will change back to show the room temperature.  
**NOTE:** If you switch from a Dry setting to OFF or to a fan setting, wait at least 3 minutes before switching back to a Dry setting.

Since fan only settings do not provide cooling, a set temperature will not be displayed. After FAN speed has been set, the display will change back to show the room temperature.  
The exhaust hose and window kit do not need to be installed when operating in fan mode."

An electronic thermostat is used to maintain the room temperature. The heater will cycle on and off to keep the room at the set level of comfort.

**NOTE:** If the TIMER was set before the power outage, it will need to be reset after power is restored.

Features and appearance may vary. Icons on the remote control indicate the selected settings

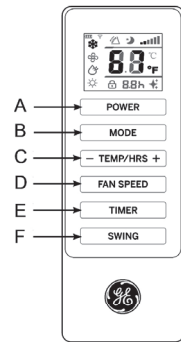

**REMOTE CONTROL**

1. Insert the two batteries. (Not provided)
2. Aim the remote control at the signal receiver on the control panel to operate the air conditioner.

**A. POWER**  
Turns the air conditioner on or off.  
**NOTE:** Turning off power by pressing the POWER button does NOT disconnect the appliance from the power supply.  
• Press the POWER button. The Power indicator will illuminate.

**B. MODE**  
Press the MODE button to toggle among the operating options. The corresponding indicator will illuminate:  
**Cool** – Cools the room to the set temperature  
**Dry** – Reduces the humidity in the room  
**Fan** – Circulates the air in the room without cooling  
**Heat** (on some models) - Heats the room to the set temperature

**C. Temperature**  
Adjusts the Temperature or Hours in Time Delay.  
**To Set the Temperature:**  
1. Press the MODE button until the Cool mode is selected.  
2. Press the + or - buttons to select the Temperature.

**Care and Cleaning**

**⚠ WARNING**

**Electrical Shock Hazard**  
Disconnect power before cleaning. Failure to do so can result in death or electrical shock.

**Air Filter**  
The air filters should be cleaned at least every two weeks for your unit to operate at optimum efficiency.

**⚠ CAUTION** DO NOT operate the air conditioner without a filter because dirt and lint will clog it and reduce performance.

- To remove:**
1. Unplug or disconnect power.
  2. Pull to remove the filter panels.
  3. Remove the filters from the panels.
  4. Wash or vacuum the dust from the air filters.
  - NOTE:** If washed, gently shake the filter to remove the excess water and dust particles trapped in the filter.
  5. Reinstall the filters onto the panels.
  6. Replace both filter panels
  7. Plug in or reconnect power

**Internal Water Tank**

The Water Full indicator ("FL" on the control panel display) illuminates when the internal water tank has filled with condensed water. The unit will not cool until the tank has been emptied to prevent overflow and possible damage to the floor under the AC.

- To Empty the Internal Water Tank:**
1. Unplug or disconnect power.
  2. Place a shallow 1 1/2 quart or larger pan (not included) below the lower drain located on the back (near the bottom) of the air conditioner.
  3. Remove the cap and the rubber plug and drain the water tank.
  4. Re-insert the drain plug and screw the cap snugly into place.
  5. Plug in or reconnect power.

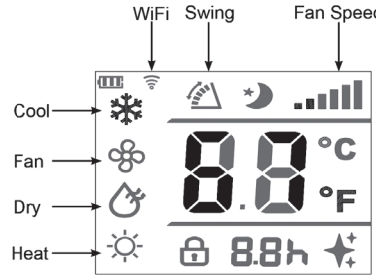

**NOTE:** The remote control vary depend of model. The buttons on remote control may have a different name or location than the remote control shows in this manual.

**NOTE:** The temperature cannot be set when the air conditioner is in either Fan or Dry mode.

**To Set the Timer:**  
1. Press the + or - buttons to select the desired hours to turn on or off.

**D. FAN SPEED**  
The FAN SPEED can be adjusted from Low, Medium, to High speed when the air conditioner is in operation.  
**NOTE:** The fan speed cannot be adjusted when the unit is in Dry mode.  
• Press the FAN SPEED button to toggle among the three speeds. The corresponding fan speed indicator will illuminate.

**E. TIMER**  
Program a time from (1-hour to 24-hours) for the air conditioner to turn Off or On. When a Time Delay is programmed, the Timer indicator light will illuminate.

**F. SWING**  
The louver on your portable air conditioner will open automatically (do not pry it open or push it shut).  
1. When your AC is turned on, the louver will swing up and down.  
2. Press the auto swing button to fix the louver in your desired position.

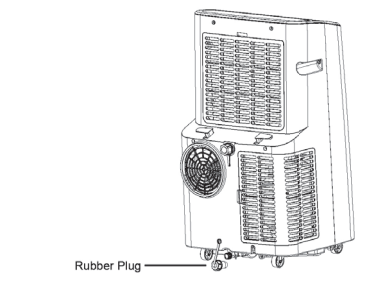
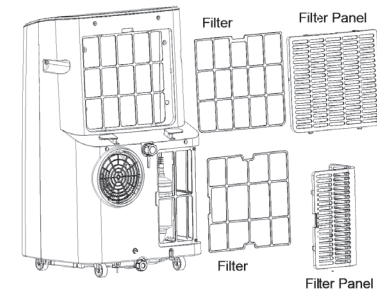

**Continuous Draining (optional and only in dry mode)**

1. Remove the top drain cap.
2. Connect a hose with a garden hose connection to the outlet.
3. Route the drain hose to a suitably sized container\* or a floor drain.

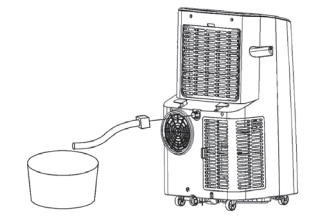

\* Be sure to use a large container (3 gallons or larger is recommended) and monitor the water level in the container continuously. The unit will not shut off when the container is full. An overflowing container can cause flooding and damage to the floor."

**Storage**

**If the unit is not being used for a long period of time: To Empty the Internal Water Tank:**

1. Unplug or disconnect power.
2. Drain the water from the water tank. (See "Internal Water Tank section".)

3. Use the original packaging to repack the unit to avoid a buildup of dust or dirt.
4. Store the air conditioner in a cool, Dry location.

**How to Insert the Batteries (not included) in the Remote Control**

1. Remove the battery cover by sliding it according to the arrow direction.
2. Insert new batteries, making sure that the (+) and (-) of battery are installed correctly.
3. Reattach the cover by sliding it back into position.

**NOTES:**

- Use 2 "AAA" (1.5 volt) alkaline batteries. Do not use rechargeable batteries.
- Remove the batteries from the remote control if the system is not going to be used for a long time.
- Do not mix old and new batteries. Do not mix alkaline, standard (carbon-zinc) or rechargeable (ni-cad, ni-mh, etc) batteries.

**Installation Instructions**

**BEFORE YOU BEGIN**  
Read these instructions completely and carefully.

- **IMPORTANT** — Save these instructions for local inspector's use.
- **IMPORTANT** — Observe all governing codes and ordinances.
- **Note to Installer** — Be sure to leave these instructions with the Consumer.
- **Note to Consumer** — Keep these instructions for future reference.
- **Skill level** — Installation of this appliance requires basic mechanical skills.
- **Completion time** — Approximately 1 hour
- We recommend that two people install this product.
- Proper installation is the responsibility of the installer.
- Product failure due to improper installation is not covered under the Warranty.
- You MUST use all supplied parts and use proper installation procedures as described in these instructions when installing this air conditioner.

**Location Requirements**

- Place the air conditioner on a flat, level surface in a location that is at least 20" (51 cm) from any wall.
- NOTE:** A minimum clearance of 20" (51 cm) from the air conditioner to the wall must be maintained to ensure proper airflow.
- Maintain a minimum 20" (51 cm) clearance around the air conditioner to not block airflow.
- Keep the air conditioner free of any obstructions such as drapes, curtains, blinds, etc.
- The exhaust hose should be free of any obstructions.
- Do not place the air conditioner on an unstable or raised surface because it could fall and cause damage or injury.
- Do not place the air conditioner in direct sunlight or near a heat source such as baseboard heaters, stoves, etc.
- The window panel can be installed in a window with a minimum 20" (51 cm) to a maximum 48" (122 cm) opening.

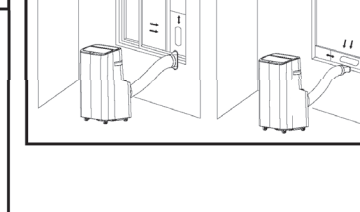
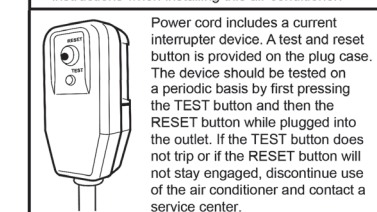

**PARTS INCLUDED (Appearance may vary)**

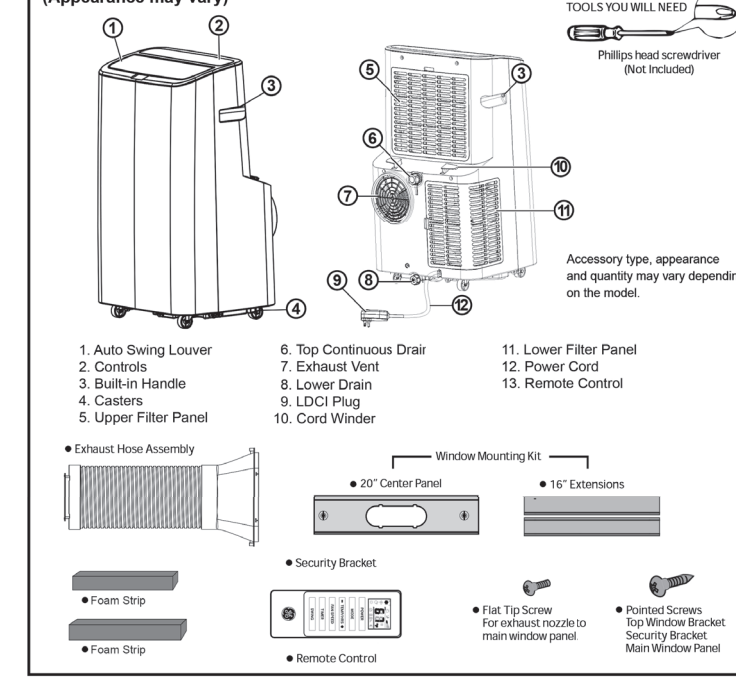

1. Auto Swing Louver
2. Controls
3. Built-in Handle
4. Casters
5. Upper Filter Panel
6. Top Continuous Drain
7. Exhaust Vent
8. Lower Drain
9. LDCI Plug
10. Cord Winder
11. Lower Filter Panel
12. Power Cord
13. Remote Control

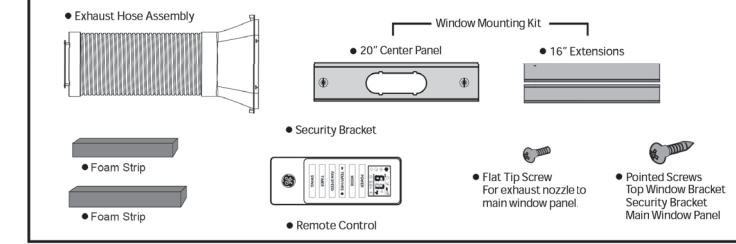



# Installation Instructions

## Window Panel Combinations to fit window openings (Appearance may vary)

Window Kit

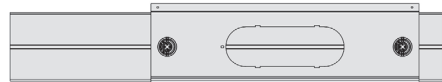

Window Opening 20"  
Center Panel Only

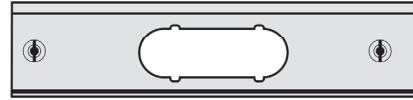

Window Opening 20" - 23½"  
Center Panel + \*5½" Extension

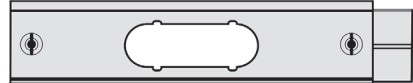

Window Opening 23½" - 27"  
Center Panel + \*9" Extension

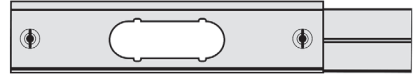

Window Opening 23½" - 30½"  
Center Panel + \*9" and \*5½" Extensions



Window Opening 30½" - 34"  
Center Panel + 16" Extension



Window Opening 34" - 41"  
Center Panel + \*9" and 16" Extensions

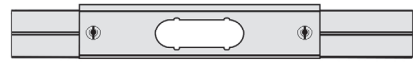

Window Opening 41" - 48"  
Center Panel + (2) 16" Extensions



\*NOTE: To achieve the desired measure it's necessary to cut the extension panel (16") with the tool of your choice.

## 1. UNPACK AIR CONDITIONER

### ⚠ WARNING

#### Excessive Weight Hazard

Use two or more people to move and install air conditioner.  
Failure to do so can result in back or other injury.

- Remove packaging materials. Save the carton and the foam packaging for storing the air conditioner when not in use.

**NOTE:** There are NO packing materials inside the air conditioner to remove—Do Not open the cabinet.

- Properly dispose of/recycle all packing material.
- Handle the air conditioner gently.
- Keep the air conditioner upright and level. Do not set the air conditioner on its side, front, back or upside down.

## 2. Assemble Exhaust Hose Assembly and Mount to Back of Unit

Extend the exhaust hose approximately 4" from each end. Screw the adapters onto the ends of the hose, turning clockwise until they are secure. Insert the round adapter into the exhaust vent on the back of the Air Conditioner and turn counter-clockwise to secure it.

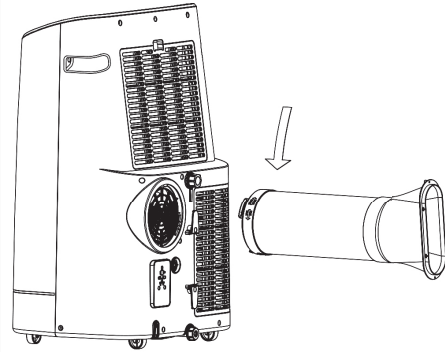

## 3. Install Exhaust Nozzle to Main Window Panel

1. Hold the main window panel so that the L-shaped edges of the panel are facing you.

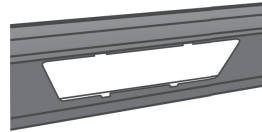

2. Align the exhaust nozzle with the slots in the opening, and then insert and slide the nozzle to access the hole from the back of the main window panel.

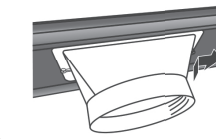

3. Turn the main window panel over, so that the nozzle is away from you. Insert a flat tip screw through the hole to fasten the window panel to the adapter.

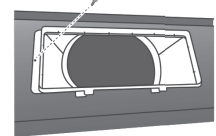

## 4. Install Main Window Panel and Extension Panels

**NOTE:** Measure the window opening and use the extension panels to fit your window.

1. Open the window and place the window kit assembly into the window.  
**NOTE:** The window assembly is designed to accommodate either a double hung or sliding window.

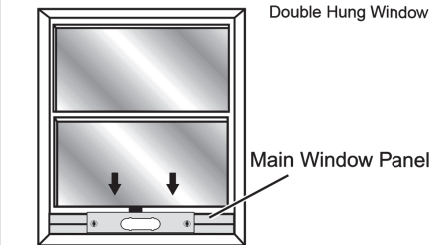

## 4. Install Main Window Panel and Extension Panels (cont)

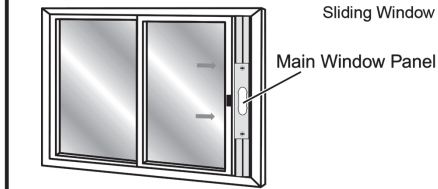

2. Adjust the extension panel(s) to the width or height of the window as shown.

3. Depending on the number of extension panels used, turn the knobs to secure the extension panel(s) to the main panel. **Install from the back.**

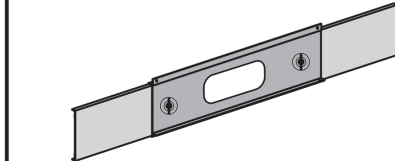

**NOTE:** There are many window types on the market today. Use the foam strips and brackets to secure the extension panels that will fit the window opening.

4. Place the window panel assembly in the window, and using the screws provided, fasten the assembly to the window sill and window frame.

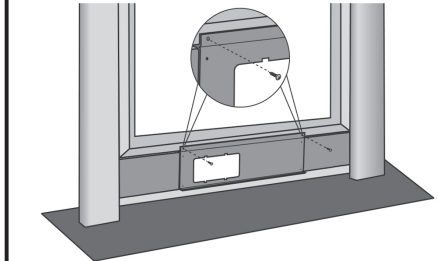

5. Using one pointed screw, install the Security bracket to the window.

**NOTE:** The security bracket prevents the window from being opened from the outside.

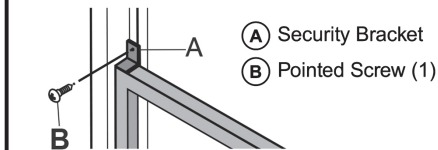

## WiFi Setup (on some models)

### GE Appliances SmarthQ (for customers in the United States)

Please visit [GEAppliances.com/connect](http://GEAppliances.com/connect) to learn more about connected appliance features, and to learn what appliance apps will work with your smart phone.

### How it Works

Download the **SmarthQ** app



Use the app to connect your room air conditioner to WiFi



Once connected, use the app to turn down your air conditioner as you leave work.



## Getting Started

To connect your room air conditioner, you'll need the GE Appliances App. The app will walk you through the connection process. Download the app from iTunes or Google Play.



All connected appliance data is held in strict accordance with the GE Appliances Connected Data Privacy Policy. Visit [geappliances.com/privacy/privacy\\_policy\\_connected](http://geappliances.com/privacy/privacy_policy_connected) to view this policy.

### Questions about SmarthQ

Get answers you need about setting up WiFi appliances and connecting to your home network in our support articles.

Visit [products.geappliances.com/appliance/gea-support-search-content](http://products.geappliances.com/appliance/gea-support-search-content) to view wifi connect room air conditioner support articles.

## REGULATORY INFORMATION

### FCC/IC Compliance Statement:

This device complies with Part 15 of the FCC Rules. Operation is subject to the following two conditions:

- This device may not cause harmful interference.
- This device must accept any interference received, including interference that may cause undesired operation.

This equipment has been tested and found to comply with the limits for a Class B digital device, pursuant to Part 15 of the FCC Rules. These limits are designed to provide reasonable protection against harmful interference in a residential installation. This equipment generates uses and can radiate radio frequency energy and, if not installed and used in accordance with the instructions, may cause harmful interference to radio communications. However, there is no guarantee that interference will not occur in a particular installation. If this equipment does cause harmful interference to radio or television reception, which can be determined by turning the equipment off and on, the user is encouraged to

try to correct the interference by one or more of the following measures:

- Reorient or relocate the receiving antenna.
- Increase the separation between the equipment and receiver.
- Connect the equipment into an outlet on a circuit different from that to which the receiver is connected.
- Consult the dealer or an experienced radio/television technician for help.

**Labelling:** Changes or modifications to this unit not expressly approved by the manufacturer could void the user's authority to operate the equipment.

\*Select Models Only

This product has WiFi capability and requires Internet connectivity and a wireless router to enable interconnection with an Energy Management System, and/or with other external devices, systems or applications.

## Troubleshooting Tips

Problem	Possible Causes	Solution
Unit does not start or operate	Power supply cord is not plugged into an outlet.	Plug the power cord into a grounded 3 prong outlet.
	Power supply cord has tripped.	Press and release the <b>RESET</b> button on the power supply cord.
	The Power button has not been pressed.	Press the <b>POWER</b> button on the Control Panel or Remote Control to turn ON the air conditioner.
	There is no power to the electrical outlet.	Plug a working lamp into the outlet to check for power.
	A household fuse has blown or a circuit breaker has tripped.	Replace the fuse or reset the circuit breaker.
	The control was programmed for a Time Delay.	Cancel the Time Delay. See "Control Panel."
	The batteries in the remote control are dead.	Replace the batteries.
Remote control is not working	The internal water tank is full. <b>NOTE:</b> The air conditioner automatically turns off, and the Water Full indicator ("FL" on the control panel display) illuminates to alert you of this condition.	Empty the water tank. See "Air Conditioner Care."
	Batteries are dead. Batteries are installed incorrectly.	Replace the batteries. Make sure the batteries are inserted in the correct position.
Air conditioner is working but the room is not cooling.	The room temperature is hot. <b>NOTE:</b> On extremely hot and humid days, the air conditioner will take longer to cool the room.	Allow time for the room to cool when you first turn on the unit. Make sure the air conditioner has an adequate BTU rating for the size of the room being cooled.
	The control is set incorrectly to Fan or Dry mode.	Set the Mode to Cool and the Fan Speed to High.
	Airflow is restricted.	Remove any obstacles to the airflow and redirect airflow for uniform cooling.
	Temperature set too high.	Lower the set temperature.
	Air filters are dirty or restricted.	Clean the air filter. See "Air Conditioner Care."
	Air conditioner installed incorrectly	Check the exhaust hose and window panel for proper installation.
	Doors and windows are open.	Close the doors and windows to the room being cooled to prevent cooled air from escaping.

## Error Codes

Error Codes	Meaning
E1	Abnormal room temperature sensor
E2	Abnormal refrigeration system sensor
FL	The internal water tank is full, refer to draining instructions

## REFURBISHED PRODUCT LIMITED THIRTY DAY WARRANTY

The **Refurbished Product Service Center** offers the following WARRANTY to the ORIGINAL purchaser of a product which we have refurbished.

This product that has been refurbished is warranted against any electronic or mechanical defects for a period of THIRTY DAYS from the date of the original purchase by the consumer. Since this unit was sold as a refurbished item, the warranty does not apply to any cosmetic appearance items such as scratches. Should a defect occur, the **Refurbished Product Service Center** will repair or, at its option, replace defective unit/parts with new or rebuilt materials without charge for either parts or labor. Replacement unit/parts will be warranted for the remaining portion of the original warranty period.

This warranty does not cover installation or damage from accident, misuse, abuse, improper wiring, incorrect voltage, operating the unit against the instructions in the owner's manual or any product which has been opened, altered, or tampered with.

This warranty does not cover costs for removal and or installation of the unit for repair. Under no circumstances shall the service center be liable for any special, incidental or consequential damages or for any other expenses incurred by reason of use or sale of this product. This warranty is in lieu of any other warranties expressed or implied warranty of merchantability of fitness for particular use or otherwise.

This warranty gives the consumer specific legal rights and they may also have other rights which vary from State to State. Some States do not follow the exclusion or limitation of incidental or consequential damages, hence the above exclusion and limitations may not apply.

**Refurbished Product Service Center**  
13225 Marquardt Avenue Santa Fe Springs, CA 90670

## WARRANTY REPAIR INFORMATION

If you need service on your unit during the 30 day warranty period; please go to [www.ConsumerServiceRefurbish.com](http://www.ConsumerServiceRefurbish.com) or call the Refurbished Product Service Center at 562-946-3531 to obtain the required claim number. Once you obtain your claim number, pack the unit properly (the original carton is ideal for this purpose) along with a copy of your purchase receipt.

Send the unit freight prepaid and insured to:

**Refurbished Product Service Center,**  
Attn: Customer Service Department 13225 Marquardt Avenue  
Santa Fe Springs, CA 90670

Your unit will be promptly exchanged and returned to you.

We will refuse to accept delivery of the returned unit unless the assigned claim number appears on the outside of the shipping carton.

**Owner's Information**  
(Keep for your permanent records)

NAME: \_\_\_\_\_

ADDRESS: \_\_\_\_\_

CITY: \_\_\_\_\_ STATE: \_\_\_\_\_

ZIP CODE: \_\_\_\_\_ PHONE: \_\_\_\_\_

E-MAIL: \_\_\_\_\_

MODEL: \_\_\_\_\_

SERIAL NO.: \_\_\_\_\_

PRINTED IN MEXICO

OBNP: 49-5000544

SHNMDL: APCD08JASW

PAGS: TAB

8 0 4 1 0 6 5 2 7



SC: 08.02.2021

REV: 009-20

ELBR: M.C.



The image shown here is for illustrative purposes only and may be subject to change.