

AN Series

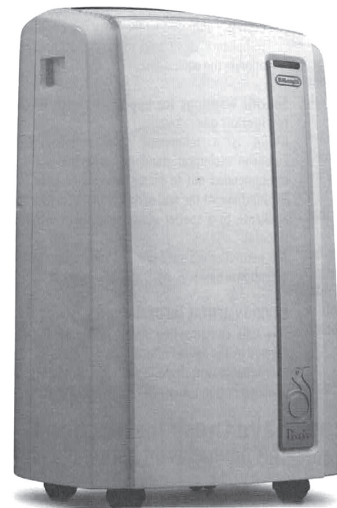

804109969

PORTABLE AIR CONDITIONER

Instructions for use. Keep these instructions

ELECTRIC CHARACTERISTICS
115 V~ 60 Hz

It's important to read this manual prior to using your new product for the first time.



Important safeguard

- Use this appliance only as described in this instruction manual.
- As with any electrical appliance, the instructions aim to cover as many situations as possible. Caution and common sense should be used when operating and installing this air conditioner.
- This appliance has been manufactured to cool and dehumidify domestic environments and must not be used for other purposes.
- It is dangerous to alter or modify the unit's characteristics in any way.
- The appliance must be installed in accordance with the relevant national legislation.
- Should repairs be necessary, contact a Service Center. Unauthorized servicing can be dangerous.
- The appliance is not intended for use by persons (including children) with reduced physical, sensory or mental capabilities, or lack of experience and knowledge, unless they have been given supervision or instruction concerning use of the appliance by a person responsible for their safety.
- Children should be supervised to ensure that they do not play with the appliance.
- If the power cable is damaged, it must be replaced by a service center in order to avoid all risk.
- Always ensure the appliance is plugged into a grounded 3-prong outlet. If you have any doubts check with a qualified electrician.
- Do not use extension cables.
- Before cleaning or maintenance operations, always unplug the unit from the outlet.
- Do not pull on or place strain on the power cord when moving the appliance.
- The appliance should not be installed where the atmosphere may contain combustible gases, oil or sulphur, or near heat sources.
- Do not rest hot or heavy objects on the appliance.
- Clean the filters at least once a week.
- Avoid using heaters near the unit.

- The unit should be transported in a vertical position. If this is not possible secure the unit at an angle, do not lie it horizontally.
- Before transporting the unit, drain the unit. After transportation, wait at least 6 hours before switching the unit on.
- The packaging materials can be recycled. You are therefore recommended to place them in the special containers for differentiated waste collection.
- This appliance is fitted with a special safety device. When the compressor switches off, this device prevents it from switching on again for at least 3 minutes.
- WARNING:** Changes or modifications not expressly approved by the party responsible for compliance could void the user's authority to operate the equipment.

Specific warnings for appliances with R410A refrigerant gas

R410A is a refrigerant that complies with European ecological standards; nevertheless, it is recommended not to pierce the cooling circuit of the machine. At the end of its useful life, deliver the appliance to a special waste collection centre for disposal. This hermetically sealed system contains fluorinated greenhouse gases.

ENVIRONMENTAL INFORMATION:

This unit contains fluorinated greenhouse gases covered by the Kyoto Protocol. Maintenance and disposal must be carried out by qualified personnel only (R410A, GWP=2088).

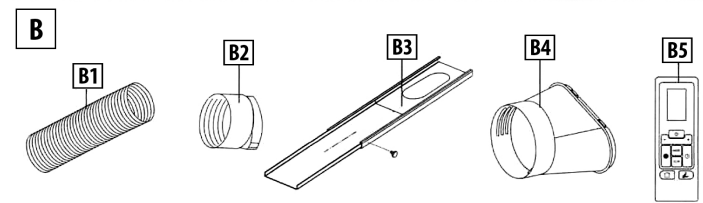
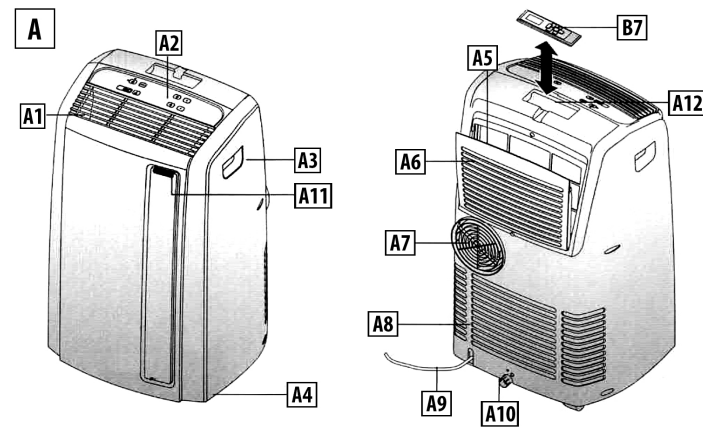

NOTE: Accessories may vary depending on the model.

The images shown here are for illustrative purposes only and may be subject to change.

INTRODUCTION

Thank you for choosing a De'Longhi product. Please take a few moments to read the instructions to avoid risks or damage to the appliance.

DESCRIPTION

Description of the appliance

- A1 air outlet
- A2 control panel
- A3 handles
- A4 castor wheels
- A5 BioSilver filter
- A6 air intake grille
- A7 air exhaust hose housing
- A8 air intake grille
- A9 power cable
- A10 drainage hose with 2 caps
- A11 remote control signal receiver
- A12 remote control compartment

Description of the accessories

- B1 air exhaust hose
- B2 hose adaptor
- B3 window bracket with pins
- B4 window outlet
- B5 remote control

Electrical connection

Before plugging the appliance into the outlet, check that:

- The outlet's power supply corresponds to the value indicated on the rating label on the back of the appliance;
- The outlet and electrical circuit are adequate for the appliance;

- The outlet is a 3-hole grounded outlet (⚡). If this is not the case, you must choose another outlet. Failure to follow these important safety instructions absolves the manufacturer of all liability.

If it becomes necessary, the power cable must be replaced by a qualified professional only.

The instructions below will enable you to prepare your air conditioner for operation as efficiently as possible. Before use, make sure the air intake and outlet grilles are unobstructed.

USE

NOTE:

This appliance is provided with an auto-evaporation feature for condensate removal during cooling and dehumidifying modes.

AIR CONDITIONING WITH INSTALLATION

For optimal results set-up your appliance in this way:

- Screw the hose adaptor B2 to the hose's end B1.
- Fit the air exhaust hose B1 in the housing at the back of the appliance. Insert it as shown in figure 1.

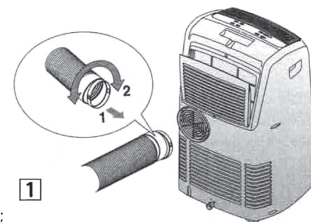

AIR CONDITIONING WITHOUT INSTALLATION

You can also set-up in a double-hung window:

- Place the window bracket in the window sill, extend the bracket fully within the window frame, fix the bracket by using the pin then lower the window onto the bracket. (Should the window bracket be too large for the window. The plastic can be cut with a saw by a qualified professional.)
- Screw the hose adaptor B2 to the hose's end B1
- Fit the air exhaust hose B1 in the relevant housing located on the rear side of the appliance. (fig. 1).
- Connect the window outlet B4 to the other end of the exhaust hose.
- Insert the window outlet end of the exhaust hose into the slot of the window bracket (fig. 2).

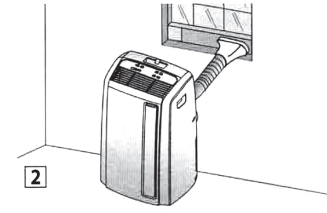

Other set-up methods:

- Thanks to the locking pins, it's possible to use the window bracket also for sliding windows. Position the hole of the bracket so to allow a correct installation of the exhaust hose (see figure 3).

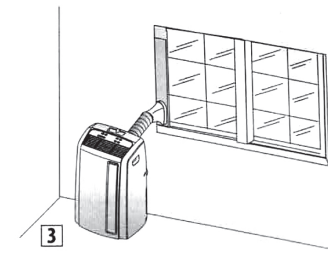

- If you have a casement window (figure 4) proceed as follows:
- Screw the hose adaptor B2 to the hose's end B1.
- Fit the air exhaust hose B1 in the relevant housing located on the rear side of the appliance. (fig. 1) then, place the window outlet B4 outside the window to exhaust the hot air.

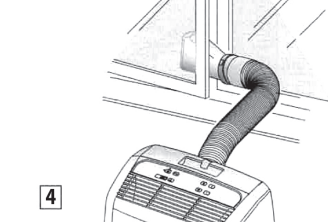

CONTROL PANEL

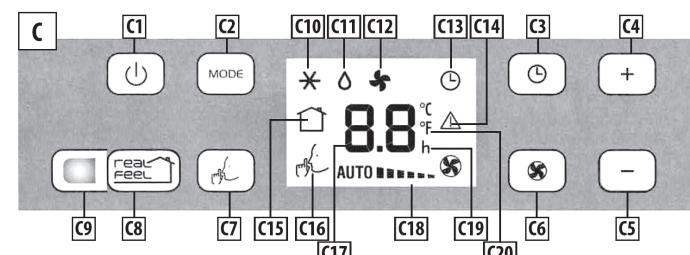

DESCRIPTION OF THE CONTROL PANEL (C)

- C1 ON/STAND-BY button
- C2 MODE selection button (conditioning, dehumidifying, fan)
- C3 Timer button
- C4 Increase temperature/programmed operation time button
- C5 Decrease temperature/programmed operation time button
- C6 Fan speed selection button (LOW/MEDIUM/HIGH/AUTO)
- C7 REAL FEEL selection button
- C8 REAL FEEL selection button
- C9 REAL FEEL light
- C10 Air-conditioning symbol
- C11 Dehumidifying symbol
- C12 Fan symbol
- C13 Timer symbol
- C14 Alarm symbol
- C15 REAL FEEL symbol
- C16 ARCTIC WHISPER symbol
- C17 temperature value set, programmed delayed ON/OFF time
- C18 Fan speed indicator
- C19 Timer indicator
- C20 Temperature selected scale indicator

Note: The panel buttons are backlit but only the buttons relevant to the active function will be on. After few seconds of the control panel inactivity, its brightness will be automatically reduced and in the next few minutes it will be further reduced.

NOTE: The images shown here are for illustrative purposes only and may be slightly different from the unit.

OPERATING FROM THE CONTROL PANEL

TURNING THE APPLIANCE ON/OFF



Before plugging the appliance check the cap on back of the unit are correctly inserted on drainage hose A10
Plug the appliance into the mains. Two lines appear on the display indicating that the appliance is in stand-by and the buttons C1 and C2 light on.

Touch C1 button to switch the appliance on.

When turned on, the air conditioner starts operating in the same mode as when it was turned off.

Note: If you don't switch on the appliance, after a few minutes, the C1 and C2 buttons switch off and the display fades to reduce energy consumption.

To turn off the appliance, touch the C1 button, then unplug the appliance.
Note: Never switch off the appliance by unplugging it: always the C1 button, wait a few minutes and then unplug. Doing so, the appliance will run a check of the operating conditions.

OPERATING FROM THE CONTROL PANEL - Cont.

REAL FEEL FUNCTION



REAL FEEL is the innovative De'Longhi technology that works simultaneously on temperature reduction and humidity control, securing best comfort level.

With traditional systems, during working time, optimal comfort conditions may be reached but not secured over time. With REAL FEEL, once optimal comfort is reached, PAC automatically modulates compressor action and fan speed, to keep it over time.

To activate the function, touch REAL FEEL button.

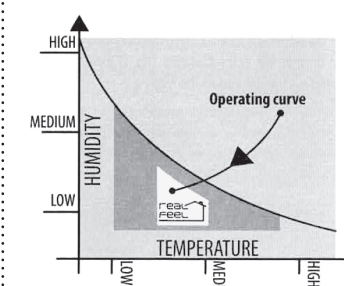

REAL FEEL light (C9) changes color when approaching the best comfort level (see following diagram).

- ORANGE LIGHT:** Room conditions far from optimal level.
- GREEN LIGHT:** Most people feel good room conditions, near optimal level.
- BLUE LIGHT:** Best comfort level.

- The well-being feeling is a subjective condition: for this reason, different people may judge differently the same environmental conditions.
- In particularly severe environmental conditions (large size of the environment, high temperature or humidity outside, poor insulation of the room, too many of people or strong heat load in the room, strong exposure to the sun ...) this device may not be able to reach the best comfort level.

AIR CONDITIONING MODE



When using the appliance in this mode, the air exhaust hose (B2) has to be connected. Ideal for hot muggy weather when you need to cool and dehumidify the room. To set this mode:

- Touch repeatedly the **MODE** button until the conditioning symbol is displayed: the display shows the desired temperature.
- Press + (C4) or - (C5) buttons to adjust the desired temperature.
- Select the fan speed by pressing the C6 button (C6). You can choose:
 - Minimum speed:** for silent operation.
 - Medium speed:** reduces noise levels while maintaining a comfortable temperature.
 - Maximum speed:** to achieve the target temperature as rapidly as possible.

AUTO the appliance automatically selects the most suitable fan speed in relation to the temperature set on the digital display and current room temperature.

The most suitable temperature for the room during the summer varies from 75°F to 81°F (24 to 27°C). You are recommended, however, not to set a temperature much below the outdoor temperature.

ARCTIC WHISPER (available in conditioning mode only)



By activating this function, the operating noise is further reduced. To activate it, touch the C7 button. The display shows the relative symbol (C17).

DEHUMIDIFYING MODE



Ideal to reduce room humidity (spring and autumn, damp rooms, rainy periods, etc.). In dehumidifying mode, the appliance **MUST** be set-up in the same way as for air conditioning, with the air exhaust hose (B1) attached to enable the moisture to be discharged outside. To set this mode:

- Touch repeatedly the **MODE** button until the dehumidifying symbol is displayed.

FAN MODE



When using the appliance in this mode, the air exhaust hose (B1) does not need to be connected.

To set this mode:

- Touch repeatedly the **MODE** button until the fan symbol is displayed.
- Select the fan speed by pressing the C6 button (C6).

You can choose:

- Minimum speed:** for silent operation.
- Medium speed:** reduces noise levels but still maintains a good level of comfort.
- Maximum speed:** for maximum fan power.

CHANGING TEMPERATURE SCALE



The temperature can be displayed in °F or °C. To change the temperature scale, turn off the unit by pushing the C1 button, then keep pushed the **MODE** button for approximately 20 seconds. The appliance emits a beep to confirm.

SETTING THE TIMER



The timer can be used to delay appliance start up or shutdown. This avoids wasting electricity by not operating the appliance when it is not needed.

How to program delayed start up

- Plug the appliance into the mains and turn the unit to standby.
- Touch the timer button (C3): the timer symbol (C13) and the number of hours come on.
- Use the + (C4) or - (C5) buttons to set the number of hours delay before the appliance comes on.
- The appliance works using the mode previously set. The appliance can be set to come on within the next 24 hours. A few seconds after set, the setting is memorised, the timer symbol is lit and the display shows that the appliance is in standby. To delete the setting, touch two times the timer button (C3). The timer symbol (C13) switches off.

How to program delayed shutdown

- With the air conditioning on, in every mode, it is possible to set the delayed shutdown.
- Touch the Timer (C3) button: the timer symbol (C13) and the hours switch on.
- Use the + (C4) or - (C5) buttons to set the number of hours delay before the appliance turns off.
- A few seconds after set, the setting is memorised, the timer symbol is lit and the display shows the current mode. At the end of the set time the appliance automatically turns in standby mode. To delete the setting, touch two times the timer button (C3). The timer symbol (C14) switches off.

Save these instructions
This product is for household only

OPERATING FROM THE REMOTE CONTROL

USING THE REMOTE CONTROL

- Point the remote control at the receiver (A11) on the air conditioner. The remote control must be no more than 16 ft (5 metres) away from the appliance (without obstacles between the remote control and the receiver).
- The remote control must be handled with extreme care. Do not drop it or expose it to direct sunlight or sources of heat.

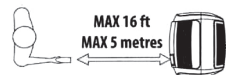

NOTE: The remote control can be safely stored in the appropriate compartment A12 (see figure).

DESCRIPTION OF THE REMOTE CONTROL (D)

- D1) ON/STAND-BY button
- D2) Increase/decrease temperature/programmed operation
- D3) "MODE" selection button
- D4) Fan speed selection button ()
- D5) REAL FEEL selection button
- D6) ARCTIC WHISPER selection button
- D7) Switch button °C/°F
- D8) TIMER button

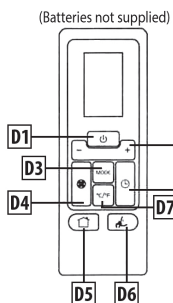

INSERTING OR REPLACING THE BATTERIES

- Remove the cover on the rear of the remote control;
- Replace the old batteries with two new R03 "AAA" 1.5V batteries (not supplied), inserting them correctly (see the instructions inside the battery compartment);
- Replace the cover.

If the remote control unit is replaced or discarded, the batteries must be removed and disposed of in accordance with current legislation as they are harmful to the environment. Do not mix old and new batteries.

Do not mix alkaline, standard (carbon-zinc) or rechargeable (nickel-cadmium) batteries. Do not dispose of batteries in fire. Batteries may explode or leak. If the remote control is not used for a certain length of time, remove the batteries.

TURNING THE APPLIANCE ON

- Plug into the outlet.
- Press the () button (D1) (when turned on, the air conditioner starts operating in the same mode as when it was turned off).
- To switch the appliance off, press button (D1) (), then remove the plug.

NOTE: Never switch the appliance off by removing the plug. Always switch it off by pushing on the () button and waiting few minutes before removing the plug. Only in this way the appliance will perform the standard checkings.

FUNCTIONS SELECTION

The controls on the remote control are the same as those on the control panel of the appliance (C). You should therefore refer to the instructions in the chapter "OPERATING FROM THE CONTROL PANEL" to select the desired functions. Press button D7, to switch the temperature display from °C to °F and vice versa.

Note:

- This equipment has been tested and found to comply with the limits for a Class B digital device, pursuant to part 15 of the FCC Rules. These limits are designed to provide reasonable protection against harmful interference in a residential installation.
- This equipment generates, uses and can radiate radio frequency energy and, if not installed and used in accordance with the instructions, may cause harmful interference to radio communications. However, there is no guarantee that interference will not occur in a particular installation. If this equipment does cause harmful interference to radio or television reception, which can be determined by turning the equipment off and on, the user is encouraged to try to correct the interference by one or more of the following measures:
 - Reorient or relocate the receiving antenna.
 - Increase the separation between the equipment and receiver.
 - Connect the equipment into an outlet on a circuit different from that to which the receiver is connected.
 - Consult the dealer or an experienced radio/TV technician for help.
- Changes or modifications not expressly approved by the party responsible for compliance could void the user's authority to operate the equipment.
- This device complies with Part 15 of the FCC Rules. Operation is subject to the following two conditions: (1) this device may not cause harmful interference, and (2) this device must accept any interference received, including interference that may cause undesired operation.
- This Class B digital apparatus complies with Canadian ICES-003.

TIPS FOR CORRECT USE

To ensure optimal results from your air conditioner, follow these recommendations:

- close the windows and doors in the room to be air conditioned. When installing the air conditioner semi-permanently, you should leave a door slightly open (as little as 0.39 inch, (1 cm)) to guarantee proper ventilation.

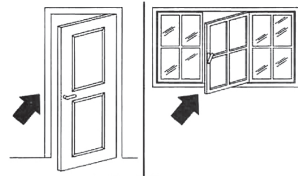

Close doors and windows

- Never use the appliance in very damp rooms (laundries for example).
- Protect the room from direct exposure to the sun by partially closing curtains and/or blinds to make the appliance much more economical to run

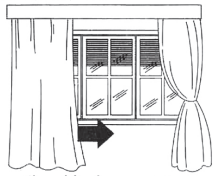

Close blinds or curtains

- Never use the appliance outdoors.
- Make sure there are no heat sources in the room;
- make sure the air conditioner is standing on a level surface.



do not cover the appliance

- Never rest objects of any kind on the air conditioner;
- Never obstruct the air intake or outlet grilles;

CLEANING

Before cleaning or maintenance, turn the appliance off by touching the () button, then unplug from the outlet.

CLEANING THE CABINET

You should clean the appliance with a slightly damp cloth then dry with a dry cloth. For safety reasons, never wash the air conditioner with water.

Precautions

Never use petrol, alcohol or solvents to clean the appliance. Never spray insecticide liquids or similar.

CLEANING THE BIO SILVER AIR FILTER

If the filter is dirty, air circulation is compromised and the efficiency of the dehumidifying and air purifying functions decreases.

It is therefore good practice to clean the filter at regular intervals. The frequency depends on the duration and conditions of operation.

If the unit is used constantly or systematically, you are recommended to clean the filter once a week. The filter is housed in the intake grille.

To clean the filter, extract as shown in fig. 5.

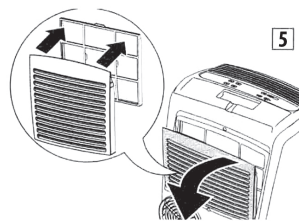

Use a vacuum cleaner to remove the dust collected on the filter. If it is very dirty, immerse in warm water and rinse a number of times. The water should never be hotter than 104°F. After washing the filter, allow it to dry completely before repositioning it. The BioSilver filter helps capture dust and pollen and helps reduce the growth of bacteria and mold on the filter.

START OF SEASON CHECKS

Make sure the power cable and plug are undamaged and the earth system is efficient. Follow the installation instructions precisely.

TROUBLESHOOTING

PROBLEM	CAUSE	SOLUTION
The air conditioner does not come on	it is not plugged into the outlet	plug into the outlet
	there is no current	wait for at least 3 minutes and try again
	the internal safety device has tripped	call the Customer Service Center
The air conditioner works for a short time only	there are bends or kinks in the air exhaust hose	position the air hose correctly, keeping it as short and free of curves as possible to avoid bottlenecks
	something is preventing the air from being discharged	check and remove any obstacles obstructing air discharge
The air conditioner works, but does not cool the room	windows, doors and/or curtains open	close doors, windows and curtains, bearing in mind the "TIPS FOR CORRECT USE" given above
	there are heat sources in the room (oven, hair dryer, etc)	eliminate the heat sources
	the air exhaust hose is detached from the appliance	fit the air exhaust hose in the housing at the back of the appliance (fig. 1).
dust filters clogged	clean or replace the filters as described above	
During operation, there is an unpleasant smell in the room	dust filter and electrostatic filter clogged	clean the filters as described above
The air conditioner does not operate for about three minutes after restarting it	prevents the appliance from being restarted until three minutes have elapsed since it was last turned off	wait. This delay is part of normal operation.
One of the following messages is displayed: Lt/Ht/Lh/PF/HL	the appliance has a self diagnosis system to identify a number of malfunctions.	see the SELF-DIAGNOSIS chapter

REFURBISHED PRODUCT LIMITED THIRTY DAY WARRANTY

The **Refurbished Product Service Center** offers the following WARRANTY to the ORIGINAL purchaser of a product which we have refurbished.

This product that has been refurbished is warranted against any electronic or mechanical defects for a period of THIRTY DAYS from the date of the original purchase by the consumer. Since this unit was sold as a refurbished item, the warranty does not apply to any cosmetic appearance items such as scratches. Should a defect occur, the **Refurbished Product Service Center** will repair or, at its option, replace defective unit/parts with new or rebuilt materials without charge for either parts or labor. Replacement unit/parts will be warranted for the remaining portion of the original warranty period.

This warranty does not cover installation or damage from accident, misuse, abuse, improper wiring, incorrect voltage, operating the unit against the instructions in the owner's manual or any product which has been opened, altered, or tampered with.

This warranty does not cover costs for removal and or installation of the unit for repair. Under no circumstances shall the service center be liable for any special, incidental or consequential damages or for any other expenses incurred by reason of use or sale of this product. This warranty is in lieu of any other warranties expressed or implied warranty of merchantability of fitness for particular use or otherwise.

This warranty gives the consumer specific legal rights and they may also have other rights which vary from State to State. Some States do not follow the exclusion or limitation of incidental or consequential damages, hence the above exclusion and limitations may not apply.

Refurbished Product Service Center
13225 Marquardt Avenue Santa Fe Springs, CA 90670

WARRANTY REPAIR INFORMATION

If you need service on your unit during the 30 day warranty period; please go to www.ConsumerServiceRefurbish.com or call the Refurbished Product Service Center at 562-946-3531 to obtain the required claim number. Once you obtain your claim number, pack the unit properly (the original carton is ideal for this purpose) along with a copy of your purchase receipt.

Send the unit freight prepaid and insured to:

Refurbished Product Service Center,
Att: Customer Service Department 13225 Marquardt Avenue Santa Fe Springs, CA 90670

Your unit will be promptly exchanged and returned to you. We will refuse to accept delivery of the returned unit unless the assigned claim number appears on the outside of the shipping carton.

Owner's Information
(Keep for your permanent records)

NAME: _____
ADDRESS: _____
CITY: _____ STATE: _____ ZIP CODE: _____
PHONE: _____ E-MAIL: _____
MODEL: _____ SERIAL NO.: _____

SELF-DIAGNOSIS

The appliance has a self diagnosis system to identify a number of malfunctions. Error messages are displayed on the appliance display.

IF ... IS DISPLAYED,	IF ... IS DISPLAYED,	IF ... IS DISPLAYED,	IF ... IS DISPLAYED,	IF ... IS DISPLAYED,
Low Temperature (frost prevention)	High Temperature	Low humidity	Probe Failure (Probe damaged)	High Level (Internal tray full)
..WHAT SHOULD I DO?	..WHAT SHOULD I DO?	..WHAT SHOULD I DO?	..WHAT SHOULD I DO?	..WHAT SHOULD I DO?
The appliance is fitted with a frost protection device to avoid excessive formation of ice. The appliance starts up again automatically when the defrosting process is completed.	The appliance is fitted with an overheating device which in case of operating conditions with excessive room temperature for a long period, will switch the appliance to ventilate only. The appliance will be automatically restored as soon as the temperature will be close to the operating limit conditions.	This message can be displayed, only in the Real Feel function. It indicates that the room humidity level is extremely low. To resume operation, switch the unit to any other mode other than the Real Feel function.	If this is displayed, contact our customer service center's toll free number.	Empty the internal safety tank following the instructions in the section "End of season operations". If HL alarm reoccurs frequently in Air Conditioning, Dehumidifying or Real Feel mode, contact our toll free customer service number.

END OF SEASON OPERATIONS

To drain all water from the circuit, remove the external cap by unscrewing it in the counter clockwise direction then, remove the internal cap from the drainage on the back of the appliance and allow the water to drain out into a basin (fig. 6).

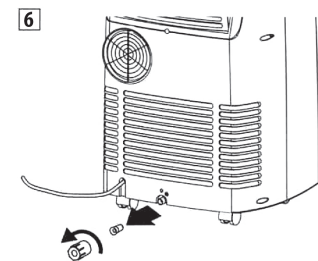

When the appliance is empty, replace the caps. Clean the filter and dry thoroughly before putting back.

TECHNICAL SPECIFICATIONS

Power supply voltage see rating label
Max. absorbed power during air conditioning "
Refrigerant "
Cooling capacity "

LIMIT CONDITIONS

Room temperature for air conditioning 61 ÷ 95 °F (16° ÷ 35 °C)
Maximum relative humidity : 80% RH

Transport, filling, cleaning, recovery and disposal of refrigerant should be performed by a technical service centre appointed by the manufacturer only.
The appliance should be disposed of by a specialist centre appointed by the manufacturer only.

TO AVOID DAMAGE TO THE UNIT:

NEVER TRANSPORT OR TURN THE APPLIANCE UPSIDE DOWN OR ON ITS SIDE. IF THIS OCCURS, WAIT 6 HOURS BEFORE TURNING THE APPLIANCE ON, 24 HOURS IS RECOMMENDED. After the unit has been on its side, oil needs to return to the compressor to ensure proper function. Without allowing the unit this time (6-24 hours) the unit may function for only a short time, and then the compressor will break down from lack of oil.

ELECTRICAL CONNECTION

This appliance is equipped with a 3 prong grounded plug. The plug must be connected into an outlet that is properly installed and grounded in the accordance with all local codes and ordinances. Do not modify the plug provided with the appliance. If it will not fit the outlet, have a proper outlet installed by a qualified electrician or relocate the unit to a proper outlet. If the household electrical supply does not meet the above specifications, or if you are not sure your home has an effective electrical ground, have a qualified electrician or your local electrical utility company check it and correct any problems.

SAFETY PLUG

The appliance is fitted with a safety plug to protect the power cable. If power is cut off, unplug from the outlet and make sure the power cable is undamaged. If the cable is damaged, call the service center immediately. If power cuts off frequently and the power cable is undamaged, contact a qualified electrician.

OPERATION OF THE SAFETY PLUG

If the safety device incorporated in the plug trips and cuts off the power supply, check that the power cable and plug are not damaged. If the power cable is undamaged, to restore operation press the "RESET" button. To verify correct operation of the plug, press the "TEST" button periodically and make sure the appliance disconnects. If this is not the case, contact the service center. To restore operation, press the "RESET" button.

804109969
PRINTED IN MEXICO Elbrd: Y.T.
OBPN: 5715113341_00_0819 SC: 10-14-2021_TAB MODEL:
PACAN270G1W1AWH_B REV2_11-02-2021_M.C: SLVDR_NVPNL