

TROUBLESHOOTING (CONT...)

| PROBLEM | POSSIBLE CAUSE(S) | SOLUTION |
|--|--|---|
| Remote control is not working | Batteries are dead. | Replace the batteries (not supplied). |
| | Batteries are installed incorrectly. | Make sure the batteries are inserted in the correct position. |
| Air conditioner is working but the room is not cooling. | The room temperature is hot. NOTE: On extremely hot and humid days, the air conditioner will take longer to cool the room. | Allow time for the room to cool when you first turn on the unit. Make sure the air conditioner has an adequate BTU rating for the size of the room being cooled. |
| | The control is set incorrectly to Fan or Dehum mode. | Set the Mode to Cool and the Fan Speed to High. |
| | Airflow is restricted. | Remove any obstacles to the airflow and redirect airflow for uniform cooling. |
| | Temperature set too high. | Lower the set temperature. |
| | Air filters are dirty or restricted. | Clean the air filter. See "Air Conditioner Care." |
| | Air conditioner installed incorrectly | Check the exhaust hose and window panel for proper installation. |
| | Doors and windows are open. | Close the doors and windows to the room being cooled to prevent cooled air from escaping. |

REFURBISHED PRODUCT LIMITED THIRTY DAY WARRANTY

The **Refurbished Product Service Center** offers the following WARRANTY to the ORIGINAL purchaser of a product which we have refurbished.

This product that has been refurbished is warranted against any electronic or mechanical defects for a period of THIRTY DAYS from the date of the original purchase by the consumer. Since this unit was sold as a refurbished item, the warranty does not apply to any cosmetic appearance items such as scratches. Should a defect occur, the **Refurbished Product Service Center** will repair or, at its option, replace defective unit/parts with new or rebuilt materials without charge for either parts or labor. Replacement unit/parts will be warranted for the remaining portion of the original warranty period.

This warranty does not cover installation or damage from accident, misuse, abuse, improper wiring, incorrect voltage, operating the unit against the instructions in the owner's manual or any product which has been opened, altered, or tampered with.

This warranty does not cover costs for removal and or installation of the unit for repair. Under no circumstances shall the service center be liable for any special, incidental or consequential damages or for any other expenses incurred by reason of use or sale of this product. This warranty is in lieu of any other warranties expressed or implied warranty of merchantability of fitness for particular use or otherwise. This warranty gives the consumer specific legal rights and they may also have other rights which vary from State to State. Some States do not follow the exclusion or limitation of incidental or consequential damages, hence the above exclusion and limitations may not apply.

Refurbished Product Service Center
13225 Marquardt Avenue Santa Fe Springs, CA 90670

WARRANTY REPAIR INFORMATION

If you need service on your unit during the 30 day warranty period; please go to www.ConsumerServiceRefurbish.com or call the Refurbished Product Service Center at 562-946-3531 to obtain the required claim number. Once you obtain your claim number, pack the unit properly (the original carton is ideal for this purpose) along with a copy of your purchase receipt.

Send the unit freight prepaid and insured to:

Refurbished Product Service Center,
Att: Customer Service Department 13225 Marquardt Avenue Santa Fe Springs, CA 90670

Your unit will be promptly exchanged and returned to you.

We will refuse to accept delivery of the returned unit unless the assigned claim number appears on the outside of the shipping carton.

Owner's Information
(Keep for your permanent records)

NAME: _____

ADDRESS: _____

CITY: _____ STATE: _____ ZIP CODE: _____

PHONE: _____ E-MAIL: _____

MODEL: _____ SERIAL NO.: _____



804109028



PRINTED IN MEXICO
SC.08.03.2018
OBPN:49-7781 11-17 GEA
SHNMDL:QPCD06AXLW1_B
Re-Desing:01-10-2019 / 4P / Elbrd:J.E.

Haier

Portable Air Conditioner Installation and User Manual

Design may vary by model number.

Some models may have an additional letter after the model number.

QPCD06AXLW
QPCD08AXLW

Please read this manual before use the unit.

AIR CONDITIONER SAFETY

Your safety and the safety of others are very important.

We have provided many important safety messages in this manual and on your appliance. Always read and obey all safety messages.



This is the safety alert symbol.

This symbol alerts you to potential hazards that can kill or hurt you and others. All safety messages will follow the safety alert symbol and either the word "DANGER," "WARNING" or "CAUTION."

These words mean:



An imminently hazardous situation. You could be killed or seriously injured if you don't immediately follow instructions.



A potentially hazardous situation which, if not avoided, could result in death or serious bodily injury.



A potentially hazardous situation which, if not avoided, may result in moderate or minor injury.

All safety messages will tell you what the potential hazard is, tell you how to reduce the chance of injury, and tell you what can happen if the instructions are not followed.

IMPORTANT SAFETY INSTRUCTIONS

WARNING: To reduce the risk of fire, electrical shock, injury to persons, or damage when using the air conditioner, follow basic precautions, including the following:

- Read all of the instructions before using this appliance.
- Plug into a grounded 3 prong outlet.
- Do not remove ground prong.
- Do not use an adapter.
- Do not use an extension cord.
- Do not operate the air conditioner if it has a damaged cord or plug, if it is not working properly, or if it has been damaged or dropped.
- The air conditioner should be serviced only by qualified service personnel.
- Disconnect power before servicing.
- Disconnect power before cleaning.
- **NOTE:** Turning off power by pressing the Power button does NOT disconnect the appliance from the power supply.
- Do not install or use the air conditioner in any area where the atmosphere contains combustible gases or where the atmosphere is contaminated. Avoid any chemicals coming in contact with your air conditioner.
- Do not store anything directly on top of the air conditioner.
- Use two or more people to move and install air conditioner.
- Never operate the air conditioner without the filters in place.
- Do not use the air conditioner near a bathtub, shower or wash basin or other wet area.

READ AND SAVE THESE INSTRUCTIONS

IMPORTANT INFORMATION

"NEITHER HAC NOR ANY PARENT, SUBSIDIARY OR OTHER AFFILIATE THEREOF MAKES ANY REPRESENTATION OR WARRANTY, EXPRESS OR IMPLIED, OF ANY KIND WHATSOEVER, INCLUDING WITHOUT LIMITATION, ANY WARRANTIES OR REPRESENTATIONS AS TO THE MERCHANTABILITY OF ANY PRODUCT, ITS FITNESS FOR A PARTICULAR PURPOSE, ELIGIBILITY FOR UL LISTING OR THAT ANY PATENTS OR TECHNOLOGY USED OR INCLUDED IN ANY PRODUCT DO NOT INFRINGE THE RIGHTS OF THIRD PARTIES. ALL HAC GUARANTEES, WARRANTIES, CONDITIONS AND REPRESENTATIONS WHATSOEVER, EITHER EXPRESS OR IMPLIED, WHETHER ARISING UNDER ANY STATUTE, LAW, COMMERCIAL USAGE OR OTHERWISE, HEREBY ARE EXPRESSLY EXCLUDED TO THE FULLEST EXTENT PERMITTED BY LAW. IN NO EVENT SHALL HAC OR ITS AFFILIATES BE LIABLE FOR ANY DIRECT, INCIDENTAL, CONSEQUENTIAL OR SPECIAL DAMAGES OF ANY KIND, INCLUDING WITHOUT LIMITATION, INJURY, DAMAGE, LOSS OF PROFITS OR LOSS OF USE. SOME STATES DO NOT ALLOW THE EXCLUSION OF WARRANTIES OR THE LIMITATION OF DAMAGES, SO THE ABOVE EXCLUSIONS AND/OR LIMITATIONS MAY NOT APPLY."

PARTS AND FEATURES

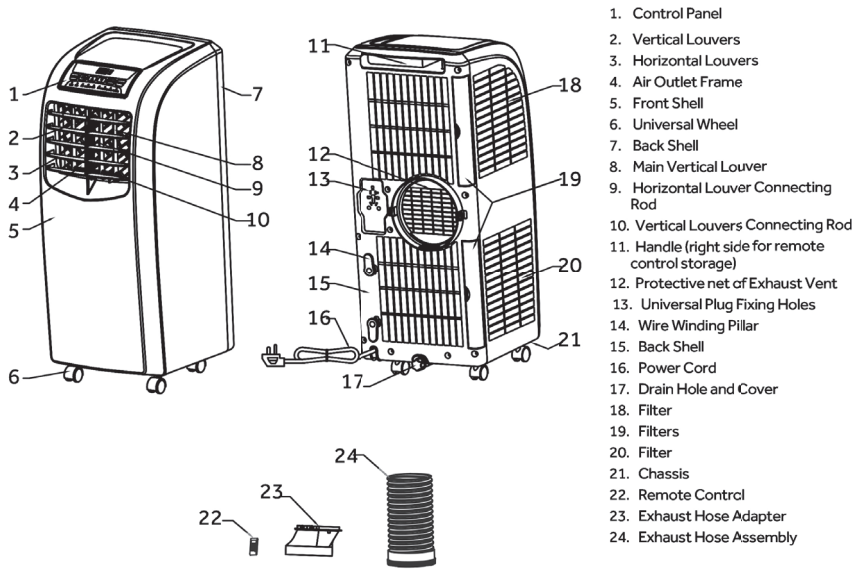

1. Control Panel
2. Vertical Louvers
3. Horizontal Louvers
4. Air Outlet Frame
5. Front Shell
6. Universal Wheel
7. Back Shell
8. Main Vertical Louver
9. Horizontal Louver Connecting Rod
10. Vertical Louvers Connecting Rod
11. Handle (right side for remote control storage)
12. Protective net of Exhaust Vent
13. Universal Plug Fixing Holes
14. Wire Winding Pillar
15. Back Shell
16. Power Cord
17. Drain Hole and Cover
18. Filter
19. Filters
20. Filter
21. Chassis
22. Remote Control
23. Exhaust Hose Adapter
24. Exhaust Hose Assembly

INSTALLATION REQUIREMENTS

TOOLS AND PARTS

Gather the required tools and parts before starting installation.

TOOLS NEEDED (NOT SUPPLIED)

- Flat-blade Screwdriver
- Phillips Screwdriver

PARTS SUPPLIED

- Main Window Panel
- Extension Panels (2)
- Flat Screws (6)
4 for extension panels
2 for nozzles
- Security Bracket

- Pointed Screws (7)
2 for top window brackets
1 for security bracket
4 for main window panel
- Exhaust Nozzle
- Exhaust Hose (1 or 2 depending on model)

AIR CONDITIONER USE

IMPORTANT: If the air conditioner has been tilted on its side, wait 24 hours before turning on the air conditioner to allow the oil to return to the compressor. This will prevent the air conditioner from failing prematurely.

- Allow 20" (51 cm) of space around the unit for proper air circulation.
- Do not operate the air conditioner without air filters in place.
- Do not spill liquid on the control panel; it may cause an electrical short to the interior electronic parts that would either disable them or cause them to function improperly.
- When turning on the air conditioner for the first time after plugging it into an electrical outlet, the unit will

start in Cooling mode set at 75°F (24°C), and at High fan speed. The control panel will display the current room temperature.

- When turning on the unit after previous use, it will remember the last settings used.
- After a normal shut down, please wait for 3 minutes before restarting the unit.
- In Cooling mode, this unit should not require water to be removed. This model has a unique design that continuously evaporates the water.
- When the unit is operated in high humidity conditions, you may need to empty the water tank periodically.
- The unit will shut down automatically when the water tank is full. The Water Full indicator illuminates to alert you of this condition.

AIR CONDITIONER CARE

⚠ WARNING



Electrical Shock Hazard

Disconnect power before cleaning.
Failure to do so can result in death or electrical shock.

CLEANING

1. Unplug or disconnect power.
2. Use only a soft cloth dampened with water to clean the cabinet.
 - Do not use a liquid or spray cleaner to clean the air conditioner.
 - DO NOT use chemicals, abrasives, ammonia, chlorine bleach, concentrated detergents, solvents or scouring pads. Some of these chemicals/items may damage and/or discolor your air conditioner.
3. Dry thoroughly with a soft cloth.
4. Plug in or reconnect power.

AIR FILTERS

The air filters should be cleaned at least once a week for your unit to operate at optimum efficiency.

IMPORTANT: Do Not operate the air conditioner without air filters in place.

1. Unplug or disconnect power.
2. Pull on the tabs to slide out the filters from the back of the air conditioner.
 - NOTE:** The secondary filters are accessible once the main filters are removed.
3. Wash or vacuum the dust from the air filters.
 - NOTE:** If washed, gently shake the filter to remove the excess water and dust particles trapped in the filter.
4. Reinstall the filters.
5. Plug in or reconnect power.

INTERNAL WATER TANK

The Water Full indicator illuminates, when the internal water tank has filled with condensed water.

To Empty the Internal Water Tank:

1. Unplug or disconnect power.
2. Place a shallow 1 quart or larger pan (not included) below the lower drain located on the back (near the bottom) of the air conditioner.
3. Remove the cap and the rubber plug and drain the water tank.
4. Re-insert the drain plug and screw the cap snugly into place.
5. Plug in or reconnect power.

STORAGE

If the unit is not being used for a long period of time:

1. Unplug or disconnect power.
2. Drain the water from the water tank. See "Air Conditioner Care."
3. Use the original packaging to repack the unit to avoid a buildup of dust or dirt.
4. Store the air conditioner in a cool, dry location.

TROUBLESHOOTING

First try the solutions suggested here

| PROBLEM | POSSIBLE CAUSE(S) | SOLUTION |
|---------------------------------------|--|--|
| Unit does not start or operate | Power supply cord is not plugged into an outlet. | Plug the power cord into a grounded 3 prong outlet. |
| | Power supply cord has tripped. | Press and release the RESET button on the power supply cord. |
| | The Power button has not been pressed. | Press the Power button on the Control Panel or Remote Control to turn ON the air conditioner. |
| | There is no power to the electrical outlet. | Plug a working lamp into the outlet to check for power. |
| | A household fuse has blown or a circuit breaker has tripped. | Replace the fuse or reset the circuit breaker. |
| | The control was programmed for a Time Delay. | Cancel the Time Delay. See "Control Panel." |
| | The batteries in the remote control are dead. | Replace the batteries. |
| | The internal water tank is full. | Empty the water tank. See "Air Conditioner Care." |
| | | NOTE: The air conditioner automatically turns off, and the Water Full indicator illuminates to alert you of this condition. |

CONTROL PANEL

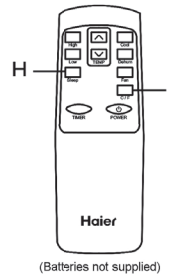
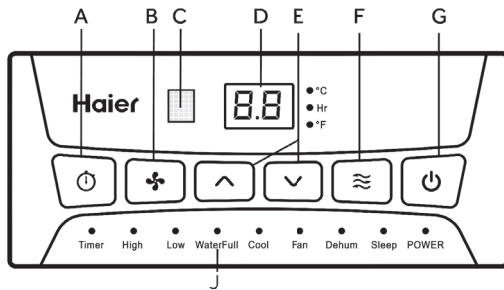

BUTTONS

A TIMER BUTTON

Program a time from (1-hour to 24-hours) for the air conditioner to turn Off or On. When a Time Delay is programmed, the Timer indicator light will illuminate.

While the air conditioner is operating:

1. Press the Timer button.
 2. Press the Up/Down arrow buttons to select the number of hours you want the air conditioner to continue to operate before turning Off.
- NOTE:** Wait approximately 5 seconds for the Turn-Off time to be saved.

While the air conditioner is off:

1. Press the Timer button.
 2. Press the Up/Down arrow buttons to select the number of hours you want the air conditioner to remain off before turning On.
- NOTE:** Wait approximately 5 seconds for the Turn-On time to be saved.

To cancel the timer:

- Press the Timer button once, the hours remaining will flash, press the timer button again and the timer will be canceled.

B FAN SPEED BUTTON

The fan speed can be adjusted from Low speed to High speed when the air conditioner is either in Cool or Fan mode.

NOTE: The fan speed cannot be adjusted when the unit is in DRY mode.

- Press the Fan Speed button to toggle among the two speeds. The corresponding fan speed indicator will illuminate.

C REMOTE CONTROL SIGNAL RECEIVING WINDOW

Aim the Remote Control at this window so the Control will receive the signal.

D CONTROL PANEL DISPLAY

Displays the Set Temperature in degrees Fahrenheit or degrees Celsius, or the hours remaining in a Time Delay. The corresponding indicator light will illuminate.

E UP AND DOWN ARROW BUTTONS

Adjusts the Temperature or Hours in Time Delay.

To Set the Temperature:

The temperature can be set between 62°F and 36°F (17°C and 30°C) when the air conditioner is in Cool mode.

1. Press the Mode button until the Cool mode is selected.
2. Press the Up Arrow or Down Arrow buttons to select the Temperature.

NOTE: The temperature cannot be set when the air conditioner is in either Fan or Dry mode.

*Note: This picture is for reference only. Please refer to the actual product for the appearance.

F MODE BUTTON

Press the Mode button to toggle among the operating options. The corresponding indicator will illuminate:

Cool – Cools the room to the set temperature

Dehum – Reduces the humidity in the room

Fan – Circulates the air in the room without cooling

G POWER BUTTON

Turns ON/OFF power to the air conditioner.

NOTE: Turning on power by pressing the Power button does NOT disconnect the appliance from the power supply.

- Press the Power button. The Power indicator will illuminate.

REMOTE CONTROL

1. Insert the two batteries (not supplied)
2. Aim the remote control at the signal receiver on the control panel to operate the air conditioner.

H SLEEP BUTTON

Increases the set temperature by 2°F (1°C) after 2-hours, and then increases the temperature by an additional 2°F (1°C) after another 2-hours.

NOTE: The fan will operate at Low speed and cannot be adjusted while in Sleep mode. The Sleep indicator will illuminate.

To Cancel Sleep Mode:

- Press the Sleep button or the Mode button (Cool, Fan or Dry) on the remote control.

I °C/°F BUTTON

• Press the °C/°F button to toggle between displaying the temperature in degrees Fahrenheit or degrees Celsius. The corresponding indicator will illuminate.

INDICATOR LIGHTS

Illuminate to indicate the selected mode, speed or condition.

J WATER FULL

The Water Full indicator illuminates, when the internal water tank has filled with condensed water. The air conditioner will turn on automatically. To drain the water tank, see "Air Conditioner Care" for instructions.

*Note: The remote may vary depending on the model.

INSTALLATION REQUIREMENTS

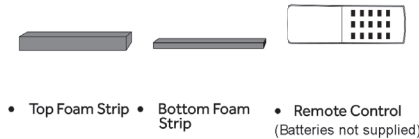

LOCATION REQUIREMENTS

- Place the air conditioner on a flat, level surface in a location that is at least 20" (51 cm) from any wall.
- NOTE:** The recommended distance from the window for optimal performance is 30" (76 cm).
- Maintain a minimum 20" (51 cm) clearance around the air conditioner to not block airflow.
- Keep the air conditioner free of any obstructions such as drapes, curtains, blinds, etc.
- The exhaust hose should be free of any obstructions.
- Do not place the air conditioner on an unstable or raised surface because it could fall and cause damage or injury.
- Do not place the air conditioner in direct sunlight or near a heat source such as baseboard heaters, stoves, etc.
- The window panel can be installed in a window with a minimum 20" (51 cm) to a maximum 40" (101.6 cm) opening.

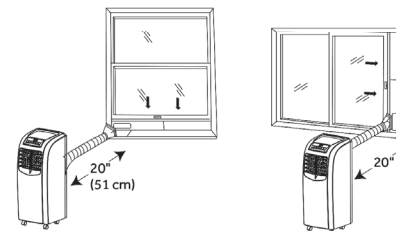

ELECTRICAL REQUIREMENTS

WARNING



Electrical Shock Hazard

Plug into a grounded 3 prong outlet.
Do not remove the ground prong from the power cord plug.
Do not use an adapter.
Do not use an extension cord.
Failure to do so can result in death, fire or electrical shock.

POWER SUPPLY CORD

Wiring Requirements

- 115 Volt, 60Hz, 15-amp fused grounded 3 prong outlet
 - The use of a time-delay fuse or time-delay circuit breaker is recommended.
 - Use a dedicated circuit only.
- NOTE:** Do not operate any other electrical appliances on this circuit or you may trip the circuit breaker/fuse.

If this power supply cord is damaged, it cannot be repaired. It must be replaced with a cord from the product manufacturer.



To test the power supply cord before operation:

1. Plug the power cord into a grounded 3 prong outlet.
2. Press the Test button, and then press and release the Reset button to restore power.

REQUIRED GROUNDING METHOD

This air conditioner must be grounded. The air conditioner is equipped with a power supply cord that has a 3 prong grounding plug. The power supply cord must be plugged into a mating, grounded 3 prong outlet, and grounded in accordance with all local codes and ordinances.



115V
15 Amp

INSTALLATION INSTRUCTIONS

STEP 1 - UNPACK AIR CONDITIONER

⚠ WARNING

Excessive Weight Hazard

Use two or more people to move and install air conditioner.

Failure to do so can result in back or other injury.

- Remove packaging materials. Save the carton and the foam packaging for storing the air conditioner when not in use.

NOTE: There are NO packing materials inside the air conditioner to remove—Do Not open the cabinet.

- Properly dispose of/recycle all packing material.
- Handle the air conditioner gently.
- Keep the air conditioner upright and level. Do not set the air conditioner on its side, front, back or upside down.

STEP 2 - INSTALL EXHAUST NOZZLE TO MAIN WINDOW PANEL

- Hold the main window panel so that the L-shaped edges of the panel are facing you.

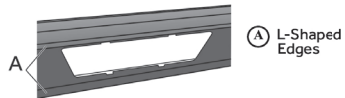

- Align the exhaust nozzle with the slots in the opening, and then insert and slide the nozzle to access the hole from the back of the main window panel.

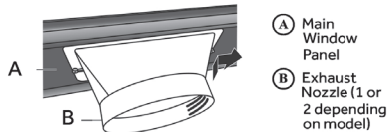

- Turn the main window panel over, so that the nozzle is away from you. Insert a flat screw through the hole to the window panel to the adapter.

NOTE: On a dual hose unit, install the smaller hose nozzle to the left-hand hole in the panel.

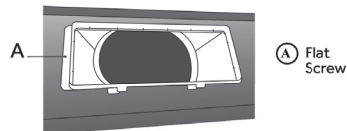

STEP 3 - INSTALL MAIN WINDOW PANEL AND EXTENSION PANELS

NOTE: Depending on the size of your window opening, use the main panel and one or both of the extension panels.

- Open the window and place the main window panel into the window.

NOTE: The window assembly is designed to accommodate either a vertical slide or horizontal slide window.

Vertical Slide Window

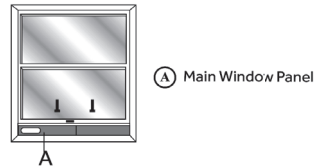

Horizontal Slide Window

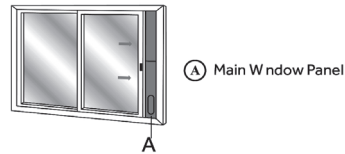

- Adjust the extension panel(s) to the width or height of the window as shown.

NOTE: Some window installations may require the extension panels to be trimmed.

- Depending on the number of extension panels used, use two or four flat screws to secure the main panel to the extension panel(s).

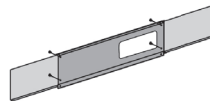

NOTE: There are many window types on the market today. Use the foam strips and brackets (provided) to secure the extension panels that fit the window opening.

INSTALLATION INSTRUCTIONS

- Place the window panel assembly in the window, and using the screws provided, fasten the assembly to the window sill and window frame.

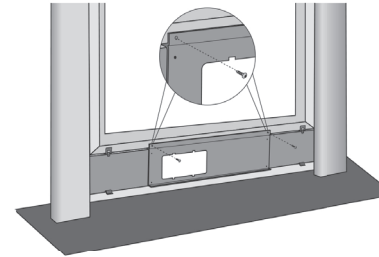

- Using one pointed screw, install the Security bracket to the window.

NOTE: The security bracket prevents the window from being opened from the outside.

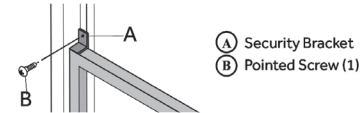

STEP 4 - ATTACH EXHAUST HOSE TO THE EXHAUST NOZZLE

- Grasp both ends of the exhaust hose and gently pull to expand the hose.

NOTE: Do not attach additional hoses to extend the length. This would decrease cooling efficiency and may damage the air conditioner.

- Using a counterclockwise motion, attach the open end of the exhaust hose to the exhaust nozzle.

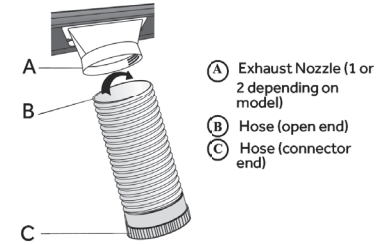

STEP 5 - CONNECT EXHAUST HOSE TO THE AIR CONDITIONER

IMPORTANT: When connecting the hose, the air conditioner must be close enough to the window that you will not dislodge the window seal plate. Once the hose is connected, move the air conditioner 20" (51 cm) from the wall.

- Align the notches on the connector end of the exhaust hose with the ridges in the opening on the back of the air conditioner.
- Using a counterclockwise motion, screw the exhaust hose (connector end) into the air outlet located on the back of the air conditioner.

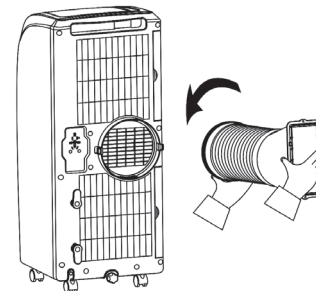

STEP 6 - COMPLETE INSTALLATION

⚠ WARNING



Electrical Shock Hazard

Plug into a grounded 3 prong outlet.

Do not remove the ground prong from the power cord plug.

Do not use an adapter.

Do not use an extension cord.

Failure to do so can result in death, fire or electrical shock.

- Plug the power cord into a grounded 3 prong outlet.
- Press the Reset button on the power cord to ensure the safety plug is providing power to the air conditioner.