

**SONY**<sup>®</sup>

AV RECEIVER

---

## Warning

**To prevent fire or shock hazard, do not expose the unit to rain or moisture.**

**To avoid electrical shock, do not open the cabinet. Refer servicing to qualified personnel only.**

**FOR THE CUSTOMERS IN THE USA. NOT APPLICABLE IN CANADA, INCLUDING IN THE PROVINCE OF QUEBEC.**

This equipment has been tested and found to comply with the limits for a Class B digital device, pursuant to Part 15 of the FCC Rules. These limits are designed to provide reasonable protection against harmful interference in a residential installation. This equipment generates, uses, and can radiate radio frequency energy and, if not installed and used in accordance with the instructions, may cause harmful interference to radio communications. However, there is no guarantee that interference will not occur in a particular installation. If this equipment does cause harmful interference to radio or television reception, which can be determined by turning the equipment off and on, the user is encouraged to try to correct the interference by one or more of the following measures:

- Reorient or relocate the receiving antenna.
- Increase the separation between the equipment and receiver.
- Connect the equipment into an outlet on a circuit different from that to which the receiver is connected.
- Consult the dealer or an experienced radio/TV technician for help.

You are cautioned that any changes or modifications not expressly approved in this manual could void your authority to operate this equipment.

This device complies with part 15 of FCC Rules and Innovation, Science and Economic Development Canada's licence-exempt RSS(s). Operation is subject to the following two conditions:

- (1) this device may not cause harmful interference, and
- (2) this device must accept any interference received, including interference that may cause undesired operation.

This transmitter must not be co-located or operated in conjunction with any other antenna or transmitter.

Under Industry Canada regulations, this radio transmitter may only operate using an antenna of a type and maximum (or lesser) gain approved for the transmitter by Industry Canada. To reduce potential radio interference to other users, the antenna type and its gain should be so chosen that the equivalent isotropically radiated power (e.i.r.p.) is not more than that necessary for successful communication.

This equipment complies with FCC/ISED radiation exposure limits set forth for an uncontrolled environment and meets the FCC radio frequency (RF) Exposure Guidelines and RSS-102 of the ISED radio frequency (RF) Exposure rules as this equipment has very low levels of RF energy.



**WARNING: Do not ingest battery, Chemical Burn Hazard.**

The remote commander contains a coin/button cell battery. If the coin/button cell battery is swallowed, it can cause severe internal burns in just 2 hours and can lead to death.

Keep new and used batteries away from children. If the battery compartment does not close securely, stop using the product and keep it away from children.

If you think batteries might have been swallowed or placed inside any part of the body, seek immediate medical attention.

**Note on the lithium battery**

Do not expose the battery to excessive heat such as direct sunlight, fire or the like.

**Warning if your car's ignition has no ACC position**

Do not install this unit in a car that has no ACC position. The display of the unit does not turn off even after turning the ignition off, and this causes battery drain.

## Important notice

### Caution

IN NO EVENT SHALL BE LIABLE FOR ANY INCIDENTAL, INDIRECT OR CONSEQUENTIAL DAMAGES OR OTHER DAMAGES INCLUDING, WITHOUT LIMITATION, LOSS OF PROFITS, LOSS OF REVENUE, LOSS OF DATA, LOSS OF USE OF THE PRODUCT OR ANY ASSOCIATED EQUIPMENT, DOWNTIME, AND PURCHASER'S TIME RELATED TO OR ARISING OUT OF THE USE OF THIS PRODUCT, ITS HARDWARE AND/OR ITS SOFTWARE.

Dear customer, this product includes a radio transmitter.

Please check your vehicle operation manual or contact the manufacturer of your vehicle or your vehicle dealer, before you install this product into your vehicle.

### Emergency calls

This BLUETOOTH car handsfree and the electronic device connected to the handsfree operate using radio signals, cellular, and landline networks as well as user-programmed function, which cannot guarantee connection under all conditions. Therefore do not rely solely upon any electronic device for essential communications (such as medical emergencies).

### On BLUETOOTH communication

- Microwaves emitting from a BLUETOOTH device may affect the operation of electronic medical devices. Turn off this unit and other BLUETOOTH devices in the following locations, as it may cause an accident.
  - where inflammable gas is present, in a hospital, train, airplane, or petrol station
  - near automatic doors or a fire alarm
- This unit supports security capabilities that comply with the BLUETOOTH standard to provide a secure connection when the BLUETOOTH wireless technology is used, but security may not be enough depending on the setting. Be careful when communicating using BLUETOOTH wireless technology.
- We do not take any responsibility for the leakage of information during BLUETOOTH communication. If you have any questions or problems concerning your unit that are not covered in this manual, contact a service center.

# Guide to Parts and Controls

## Main unit

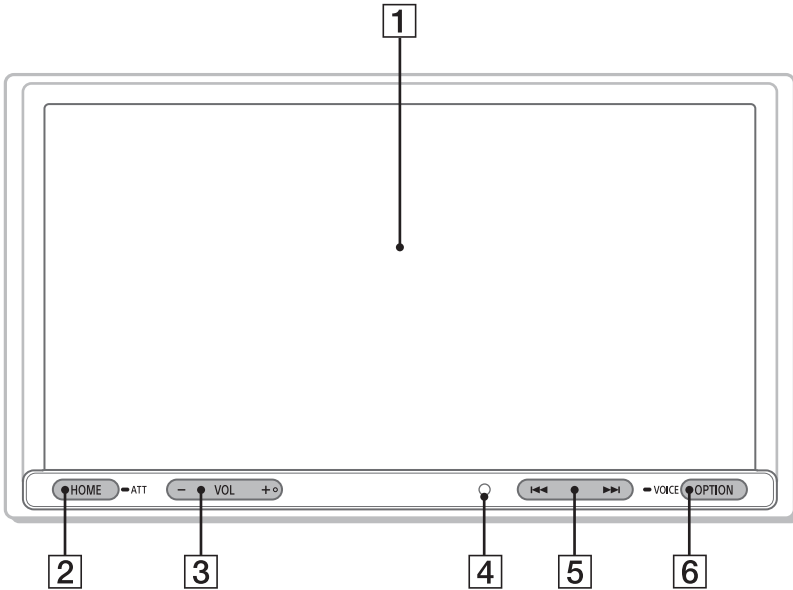

The VOL (volume) + button has a tactile dot.

**1 Display/touch panel**

**2 HOME**

Open the HOME menu.

**ATT (attenuate)**

Press and hold for 1 second to attenuate the sound.

To cancel, press and hold again, or press VOL +.

**3 VOL (volume) +/-**

**4 Receptor for the remote commander**

**5 <</>> (previous/next)**

– Move to the previous/next item.

– Press and hold to fast-reverse/fast-forward.

**6 OPTION**

Open the OPTION screen .

**VOICE**

Press and hold to activate the voice command function for Apple CarPlay and Android Auto.

• The images shown here are for illustrative purposes only and may be subject to change, the actual descriptions of control panel and their locations may vary depending on the model.

## RM-X170 remote commander

The remote commander can be used to operate the audio controls. For menu operations, use the touch panel.

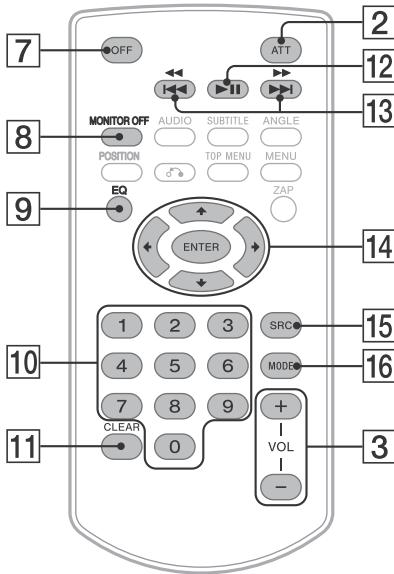

### 14 ◀/▶/◂/▸

Functions differ depending on the selected source.

- Tuner: select a preset station or tune into a station automatically.
- USB: select a folder or move to the previous/next file.

### ENTER

Enter the selected item.

### 15 SRC (source)

Change the source. Each time you press this button, a selectable source is displayed in a popup on the current display.

### 16 MODE

Select the radio band.

### Note

The white buttons in the illustration above are not supported.

### 7 OFF

Turn the source off.

### 8 MONITOR OFF

Turn off the monitor.  
To turn back on, press again.

### 9 EQ (equalizer)

Select an equalizer curve.

### 10 Number buttons (0 - 9)

### 11 CLEAR

### 12 ▶|| (play/pause)

### 13 ◀◀/▶▶ (previous/next)

◀◀/▶▶ (fast-reverse/fast-forward)

• The remote control vary depend of model: The buttons on the remote control may have a different name or location than the remote control shows in this manual.

## Screen displays

### Playback screen:

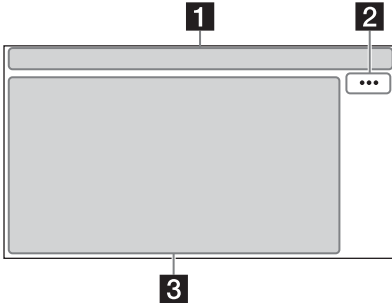



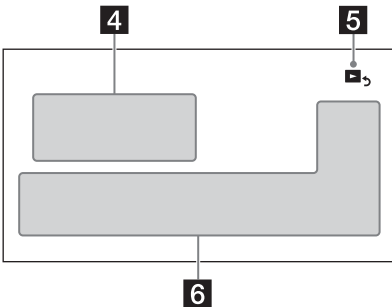

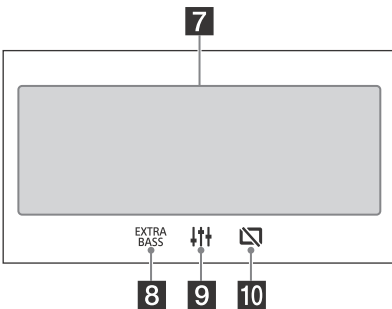

### HOME screen:



### OPTION screen:



### 1 Status indication

-  ATT Lights up when the sound is attenuated.
-  Lights up when the audio device is playable by enabling the A2DP (Advanced Audio Distribution Profile).
-  Lights up when handsfree calling is available by enabling the HFP (Handsfree Profile).
-  Indicates the signal strength status of the connected cellular phone.
-  Indicates the remaining battery status of the connected cellular phone.
-  Lights up when the Bluetooth® signal is on. Flashes when the connection is in progress.

### 2 ... (source option)

Open the source option menu. The available items differ depending on the source.

### 3 Application specific area

Display playback controls/indications or show the unit's status. Displayed items differ depending on the source.

### 4 Clock

### 5 ▶ (return to the playback screen)

Switch from the HOME screen to the playback screen.

### 6 Sources and Settings select keys

Change the source or make various settings. Display the setting icon and other icons by swiping the bottom of this area right or left.

### 7 Sources select keys

Change the source.

### 8 EXTRA BASS

Change the EXTRA BASS setting.

### 9 EQ10/Subwoofer

Change the EQ10/Subwoofer setting.

### 10 (monitor off)

Turn off the monitor. When the monitor is turned off, touch any part of the display to turn it back on.

## Getting Started

### Performing Initial Settings

You need to perform initial settings before operating the unit for the first time, after replacing the car battery, or changing connections.

If the initial settings screen does not appear when you turn on the unit, perform the factory reset to initialize the unit.

- 1 Touch [Language], then set the display language.
- 2 Touch [Demo] repeatedly to select [OFF] to disable the demonstration mode.
- 3 Touch [Set Date/Time], then set the date and time.
- 4 After setting the date and time, touch [OK].
- 5 To return to the previous display, touch ↩, then touch [OK].  
The startup caution appears.
- 6 Read through the startup caution, then if you accept all conditions, touch [Close].  
The setting is complete.

This setting can be further configured in the setting menu.

### Preparing a BLUETOOTH Device



You can enjoy music or perform handsfree calling depending on the BLUETOOTH compatible device such as smartphones, cellular phones, and audio devices (hereafter "BLUETOOTH device" if not otherwise specified). For details on connecting, refer to the operating instructions supplied with the device.

Before connecting the device, turn down the volume of this unit; otherwise, a loud sound may result.

### Pairing and connecting with a BLUETOOTH device

When connecting a BLUETOOTH device for the first time, mutual registration (called "pairing") is required. Pairing enables this unit and other devices to recognize each other.



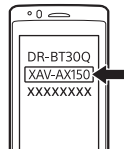

- 1 Place the BLUETOOTH device within 1 m (3 ft) of this unit.
- 2 Press HOME, then touch [Settings].
- 3 Touch [Bluetooth].
- 4 Touch [Bluetooth Connection], then set the signal to [ON].  
The BLUETOOTH signal is turned on and  lights up on the status bar of the unit.
- 5 Touch [Pairing].  
 flashes while the unit is in pairing standby mode.
- 6 Perform pairing on the BLUETOOTH device so it detects this unit.
- 7 Select [XAV-AX150] shown in the display of the BLUETOOTH device.  
If your model name does not appear, repeat from step 5.



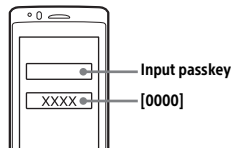

- 8 If passkey\* input is required on the BLUETOOTH device, input [0000].

\* Passkey may be called "passcode," "PIN code," "PIN number," "password," etc., depending on the BLUETOOTH device.



When pairing is made,  stays lit.

- 9 Select this unit on the BLUETOOTH device to establish the BLUETOOTH connection.  
 or  lights up when the connection is made.

#### Notes



- The unit can only be connected with one BLUETOOTH device at a time.
- To disconnect the BLUETOOTH connection, turn the connection off from either the unit or the BLUETOOTH device.
- BLUETOOTH pairing is not possible while Apple CarPlay or Android Auto is running.



## Connecting with a paired BLUETOOTH device

To use a paired device, connection with this unit is required. Some paired devices will connect automatically.



- 1 Press HOME, then touch [Settings].
- 2 Touch [Bluetooth].
- 3 Touch [Bluetooth Connection], then touch [ON].  
Make sure that  lights up on the status bar of the unit.
- 4 Activate the BLUETOOTH function on the BLUETOOTH device.
- 5 Operate the BLUETOOTH device to connect to this unit.  
 or  lights up on the status bar.

### To connect the last-connected device from this unit

When the ignition is turned on with the BLUETOOTH signal activated, this unit searches for the last-connected BLUETOOTH device, and connection is made automatically.

#### Note

While streaming BLUETOOTH audio, you cannot connect from this unit to the cellular phone. Connect from the cellular phone to this unit instead.

### To install the microphone

For details, see "Installing the microphone".

## Connecting Rear View Camera

By connecting the optional rear view camera to the CAMERA IN terminal, you can display the picture from the rear view camera. For details, see "Connection/Installation".

### To display the picture from the rear view camera

Press HOME, touch [Rear Camera].

## Listening to the Radio

### Listening to the Radio

To listen to the radio, press HOME then touch [Tuner].

#### Reception controls/indications

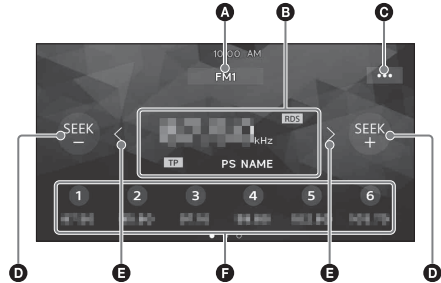

#### A Current band

Change the band (FM1, FM2, FM3, AM1 or AM2).

#### B Current frequency, program service name\*, RDS (Radio Data System) indication\*

\* During RDS reception.

#### C ... (tuner option)

Open the tuner option menu.

#### D SEEK-/SEEK+

Tune in automatically.

#### E </>

Tune in manually.

Touch and hold to continuously skip frequencies.

#### F Preset numbers

Select a preset station. Swipe right/left to show the other preset stations.

Touch and hold to store the current frequency in that preset.

## Tuning

- 1 Select the desired band (FM1, FM2, FM3, AM1 or AM2).

- 2 Perform tuning.

#### To tune automatically

Touch SEEK-/SEEK+.

Scanning stops when the unit receives a station.

#### To tune manually

Touch and hold </> to locate the approximate frequency, then touch </> repeatedly to finely adjust to the desired frequency.

## Storing manually

- 1 While receiving the station that you want to store, touch and hold the desired preset number.

## Receiving stored stations

- 1 Select the band, then touch the desired preset number.

## Using Tuner Option Functions

The following functions are available by touching ...

### BTM (Best Tuning Memory)

Stores stations in order of frequency on the preset numbers. 18 stations can be stored for FM and 12 stations for AM as preset stations.

### PTY\*

Select a program type from the PTY list to search for a station broadcasting the selected program type.

\* Only available during FM reception.

## Playback

### Playing a USB Device

MSC (Mass Storage Class) type USB devices\* compliant with the USB standard can be used.

\* e.g., a USB flash drive, digital media player, Android™ phone

#### Notes

- USB devices formatted with file systems FAT12/16/32/exFAT are supported.
- For details on the compatibility of your USB device, visit the support site on the back cover.
- For details on the supported file formats, see "Supported formats for USB playback".

- 1 Turn down the volume on the unit.
- 2 Connect the USB device to the USB port.
- 3 Press HOME, then touch [USB].

Playback starts.

#### To remove the device

Turn the unit off or turn the ignition switch to the ACC off position, then remove the USB device.

### Playing a BLUETOOTH Device

You can play contents on a connected device that supports BLUETOOTH A2DP (Advanced Audio Distribution Profile).



- 1 Make a BLUETOOTH connection with the audio device.
- 2 Press HOME, then touch [BT Audio].
- 3 Operate the audio device to start playback.

#### Notes

- Depending on the audio device, information such as title, track number/time, and playback status may not be displayed on this unit.
- Even if the source is changed on this unit, playback of the audio device does not stop.
- BLUETOOTH pairing is not possible while Apple CarPlay is running.



#### To match the volume level of the BLUETOOTH device to other sources

You can reduce the volume level differences between this unit and the BLUETOOTH device: During playback, touch ..., then set [Input Level] between -6 and +6.

---

## Searching and Playing Tracks

### Repeat play and shuffle play

- 1 During playback, touch  (repeat) or  (shuffle) repeatedly until the desired play mode appears.



Playback in the selected play mode may take time to start.

Available play modes differ depending on the selected sound source and connected device.

### Searching for a file from the list screen

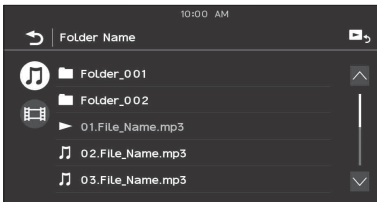
- 1 During USB playback, touch . The list screen from the currently played item appears.



Furthermore, touch  (audio) or  (video) to list up by file type.

- 2 Touch the desired item. Playback starts.

---

## Other Settings During Playback

Further settings are available in each source by touching . The available items differ depending on the source.

---

### Picture EQ

Adjusts the picture quality according to your taste: [Dynamic], [Standard], [Theater], [Custom]. (Available only when the parking brake is applied and USB video is selected.)

---

### Aspect

Selects an aspect ratio for the screen of the unit. (Available only when the parking brake is applied and USB video is selected.)

#### Normal

Displays a 4:3 picture in its original size, with side bars to fill the 16:9 screen.

#### Zoom

Displays a 16:9 picture that has been converted into 4:3 letter box format.

#### Full

Displays a 16:9 picture in its original size.

#### Captions

Enlarges the picture horizontally, while fitting captions in the screen.

---

- Accessory type and quantity may vary depending on the model.
- The image shown here is for illustrative purposes only and may be subject to change.
- The remote control vary depend of model: The buttons on the remote control may have a different name or location than the remote control shows in this manual.
- The cables mentioned in this guide is not supplied with your unit.
- The images shown here are for illustrative purposes only and may be subject to change, the actual descriptions of control panel and their locations may vary depending on the model.

## Handsfree Calling

To use a cellular phone, connect it with this unit. For details, see “Preparing a BLUETOOTH Device”.



### Note

The handsfree calling functions explained below are available only when the Apple CarPlay or Android Auto function is deactivated. When the Apple CarPlay or Android Auto function is activated, use the handsfree calling functions on its application.

## Receiving a Call

- 1 Touch when a call is received.  
The phone call starts.

### Note

The ringtone and talker's voice are output only from the front speakers.

### To reject/end a call

Touch .

## Making a Call

- 1 Press HOME, then touch [Phone].
- 2 Touch one of the call icons on the BLUETOOTH phone display.

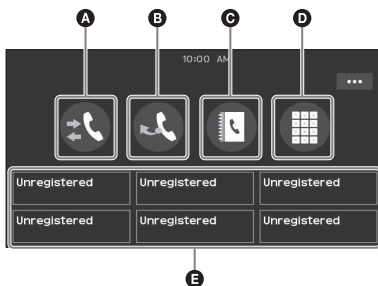

- A (call history)\*  
Select a contact from the call history list. The unit stores the last 20 calls.
- B (redial)  
Make a call automatically to the last contact you made.

- C (phonebook)\*

Select a contact from the name list/number list in the phonebook. To search for the desired contact in alphabetical order from the name list, touch .

- D (phone number input)

Enter the phone number.

- E Preset phone number list

Select the stored contact.

To store the contact, see “Presetting phone numbers”.

\* The cellular phone needs to support PBAP (Phone Book Access Profile).

- 3 Touch .

The phone call starts.

## Presetting phone numbers

You can store up to 6 contacts in the preset list.

- 1 In the phone screen, select a phone number that you want to store in the preset dial from the phonebook.  
The confirmation display appears.
- 2 Touch [Add to Preset].
- 3 Select the preset phone number list where the phone number is stored.  
The contact is stored in the preset phone number list.

## Available Operations During a Call

### To adjust the ringtone volume

Press VOL +/- while receiving a call.

### To adjust the talker's voice volume

Press VOL +/- during a call.

### To adjust the volume for the other party (Mic gain adjustment)

During a handsfree call, touch **\*\*\***, then set [MIC Gain] to [High], [Middle], or [Low].

### To reduce echo and noise (Echo/noise canceler mode)

During a call, touch **\*\*\***, then set [Speech Quality] to [Mode 1] or [Mode 2].

### To switch between handsfree mode and handheld mode

During a call, touch  to switch the phone call audio between the unit and cellular phone.

#### Note

Depending on the cellular phone, this operation may not be available.

### To answer an incoming call automatically

Touch **\*\*\***, then set [Auto Answer] to [ON].

## Useful Functions

### Apple CarPlay

Apple CarPlay lets you use your iPhone in the car in a way that allows you to stay focused on the road. (Available only when your iPhone is connected to the USB port.)

#### Notes on using Apple CarPlay

- iPhone with iOS 7.1 or later is required. Update to the latest iOS version before use.
- Apple CarPlay can be used on iPhone 5 or later.
- For details on compatible models, refer to the compatibility list on the support site on the back cover.
- For details about Apple CarPlay, refer to the manual supplied with your iPhone, or visit the website of Apple CarPlay.
- Since the GPS on your iPhone is used, place your iPhone where it can easily receive a GPS signal.

#### 1 Connect your iPhone to the USB port.

To connect an iPhone, use a USB connection cable for iPhone (not supplied).

#### 2 Press HOME, then touch the Apple CarPlay icon.

Your iPhone's display appears on the display of the unit. Touch and control the applications.

Use of the Apple CarPlay logo means that a vehicle user interface meets Apple performance standards. Apple is not responsible for the operation of this vehicle or its compliance with safety and regulatory standards.

Please note that the use of this product with iPhone may affect wireless performance.

## Android Auto™

Android Auto extends the Android platform into the car in a way that's purpose-built for driving. (Available only when your Android phone is connected to the USB port.)

### Notes on using Android Auto

- Android phone with Android 5.0 or higher is required. Update to the latest OS version before use.
- Your Android phone needs to support Android Auto. For details on compatible models, refer to the compatibility list on the support site on the back cover.
- Download the Android Auto application on Google Play.
- Since the GPS on your Android phone is used, place your Android phone where it can easily receive a GPS signal.
- Android Auto may not be available in your country or region.

**1** Connect your Android phone to the USB port.

To connect an Android phone, use an appropriate connection cable (not supplied).

**2** Press HOME, then touch the Android Auto icon.





The Android Auto interface will be displayed full-screen on the display of the unit. Touch and control the applications.

## Using Gesture Command

You can perform frequently-used operations by swiping your finger on the reception/playback display.

### Note

The gesture commands explained below are not available on the screens of Apple CarPlay and Android Auto.

Do this	To
 Swipe left to right	<b>Radio reception:</b> seek forward stations. (The same as pressing and holding ►►.)
 Swipe right to left	<b>Radio reception:</b> seek backward stations. (The same as pressing and holding ◀◀.)
 Swipe upwards	<b>Radio reception:</b> receive stored stations (go forward).
 Swipe downwards	<b>Radio reception:</b> receive stored stations (go backward).

## Settings

### Basic Setting Operation

You can set items in the following setup categories: General Settings (General), Sound Settings (Sound), Visual Settings (Visual), BLUETOOTH Settings (Bluetooth)

- 1 Press HOME, then touch [Settings].
- 2 Touch one of the setup category.  
The items that can be set differ depending on the source and settings.
- 3 Move the scrollbar up and down to select the desired item.

#### To return to the previous display

Touch .

#### To switch to the playback screen

Touch .

### General Settings (General)

#### Language

Selects the display language: [English], [Español], [Français], [Deutsch], [Italiano], [Português], [Русский], [ไทย], [العربية], [简体中文], [繁體中文], [한국어].

#### Demo

Activates the demonstration: [OFF], [ON].

#### Date/Time

##### Date Format

Selects the format: [DD/MM/YY], [MM/DD/YY], [YY/MM/DD].

##### Time Format

Selects the format: [12-hour], [24-hour].

##### Set Date/Time

Sets the date and clock time manually.

#### Beep

Activates the operation sound: [OFF], [ON].

#### Rear View Camera

Selects the image from the rear view camera: [OFF], [Normal], [Reverse] (mirror image).

[Guide Line Adjust] adjusts the guide on the picture from the rear view camera.

Touch the near side **A** or far side **B** (red portions) of the

picture to adjust.

Touch </^/>/~ to adjust the guide position, and touch

[→←] or [↔] to adjust the guide width.

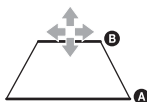

#### Steering Control

Selects the input mode for the connected remote control. To prevent a malfunction, be sure to match the input mode with the connected remote control before use.

##### Custom

Input mode for the steering wheel remote control (follow the procedures of [ ] to register functions on the connected remote control).

##### Preset

Input mode for the wired remote control excluding the steering wheel remote control.



The steering button panel appears.

1 Press and hold the button you want to assign to the steering wheel.

The button on the panel lights up (standby).

2 Press and hold the button on the steering wheel you want to assign the function to.

The button on the panel will change the color (highlighted or encircled by an orange line).

3 To register other functions, repeat steps 1 and 2.

(Available only when [Steering Control] is set to [Custom].)

##### Notes

- While making settings, the connected remote control cannot be used even though some functions have already been registered. Use the buttons on the unit.
- If an error occurs while registering, all the registered information is cleared. Restart registration from the beginning.
- This function may not be available on some vehicles. For details on the compatibility of your vehicle, visit the support site on the back cover.

#### Clock Time

Sets the clock time by the RDS data: [OFF], [ON].

#### Factory Reset

Initializes all the settings to the factory settings.

#### Firmware Version

Updates and confirms the firmware version.

#### Open Source Licenses

Displays the software licenses.

---

## Sound Settings (Sound)

---

### EXTRA BASS

Reinforces bass sound in synchronization with the volume level: [OFF], [1], [2].

---

### EQ10/Subwoofer

Selects an equalizer curve and adjusts the subwoofer level.

#### EQ10

Selects the equalizer curve: [OFF], [R&B], [Rock], [Pop], [Hip-Hop], [Dance], [EDM], [Jazz], [Soul], [Country], [Custom].

[Custom] adjusts the equalizer curve: -6 to +6.

#### Subwoofer

Adjusts the volume level of the subwoofer: [OFF], -10 to +10.

(Available when any source is selected.)

---

### Balance/Fader

Adjusts the balance/fader level.

#### Balance

Adjusts the sound balance between the left and right speakers: [L15] to [R15].

#### Fader

Adjusts the sound balance between the front and rear speakers: [Front 15] to [Rear 15].

---

### Crossover

Adjusts the cut-off frequency and subwoofer phase.

#### High Pass Filter

Selects the cut-off frequency of the front/rear speakers: [OFF], [50Hz], [60Hz], [80Hz], [100Hz], [120Hz].

#### Low Pass Filter

Selects the cut-off frequency of the subwoofer: [OFF], [50Hz], [60Hz], [80Hz], [100Hz], [120Hz].

#### Subwoofer Phase

Selects the subwoofer phase: [Normal], [Reverse].

---

### DSO (Dynamic Stage Organizer)

Enhances audio output: [OFF], [Low], [Middle], [High].

---

---

## Visual Settings (Visual)

---

### Wallpaper

Changes the wallpaper by touching the desired color.

---

### Dimmer

Dims the display: [OFF], [Auto], [ON].

([Auto] is available only when the illumination control lead is connected and works when the head light is turned on.)

[] adjusts the brightness level when the dimmer is activated: -5 to +5.

---

### Touch Panel Adjust

Adjusts the touch panel calibration if the touching position does not correspond with the proper item.

---

---

## BLUETOOTH Settings (Bluetooth)

---

### Bluetooth Connection

Activates the BLUETOOTH signal: [OFF], [ON], [Pairing] (enters into pairing standby mode).

---

### Bluetooth Device Info

Displays the information of the device connected to the unit.

(Available only when [Bluetooth Connection] is set to [ON] and a BLUETOOTH device is connected to the unit.)

---

### Bluetooth Reset

Initializes all BLUETOOTH-related settings such as pairing information, call history, history of connected BLUETOOTH devices, etc.

---



## Additional Information

### Updating the Firmware

To update the firmware, visit the support site on the back cover, then follow the online instructions.

#### Note

During the update, do not remove the USB device.

### Precautions

- Power antenna (aerial) extends automatically.
- When you transfer ownership or dispose of your car with the unit installed, initialize all the settings to the factory settings by performing the factory reset.
- Do not splash liquid onto the unit.

#### Notes on safety

- Comply with your local traffic rules, laws, and regulations.
- While driving
  - Do not watch or operate the unit, as it may lead to distraction and cause an accident. Park your car in a safe place to watch or operate the unit.
  - Do not use the setup feature or any other function which could divert your attention from the road.
  - When backing up your car, be sure to look back and watch the surroundings carefully for your safety even if the rear view camera is connected. Do not depend on the rear view camera exclusively.
- While operating
  - Do not insert your hands, fingers, or foreign objects into the unit as it may cause injury or damage to the unit.
  - Keep small articles out of the reach of children.
  - Be sure to fasten seatbelts to avoid injury in the event of sudden movement of the car.

#### Preventing an accident

Pictures appear only after you park the car and set the parking brake.  
If the car starts moving during video playback, the following caution is displayed and you cannot watch the video.

#### [Video blocked for your safety.]

Do not operate the unit or watch the monitor while driving.

#### Notes on LCD panel

- Do not get the LCD panel wet or expose it to liquids. This may cause a malfunction.



- Do not press down hard on the LCD panel as doing so can distort the picture or cause a malfunction (i.e., the picture may become unclear or the LCD panel may be damaged).
- Do not touch the panel with objects other than with your finger as it may damage or break the LCD panel.
- Clean the LCD panel with a dry soft cloth. Do not use solvents such as benzine, thinner, commercially available cleaners, or antistatic spray.
- Do not use the unit outside the temperature range 0 °C – 40 °C (32 °F – 104 °F).
- If your car was parked in a cold or hot place, the picture may not be clear. However, the monitor is not damaged and the picture will become clear after the temperature in your car becomes normal.
- Some stationary blue, red, or green dots may appear on the monitor. These are called “bright spots” and can happen with any LCD. The LCD panel is precision-manufactured with more than 99.99% of its segments functional. However, it is possible that a small percentage (typically 0.01%) of the segments may not light up properly. This will not, however, interfere with your viewing.

#### Notes on the touch panel

- This unit uses a resistive touch panel. Touch the panel directly with your fingertip.
- Multi-touch operation is not supported on this unit.
- Do not touch the panel with sharp objects such as a needle, pen, or fingernail. Operation with a stylus is not supported on this unit.
- Do not let any objects contact the touch panel. If the panel is touched by an object other than your fingertip, the unit may not respond correctly.
- Since glass material is used for the panel, do not subject the unit to strong shock. If cracking or chipping occurs on the panel, do not touch the damaged part as it may cause injury.
- Keep other electrical devices away from the touch panel. They may cause the touch panel to malfunction.

## Supported formats for USB playback

- WMA (.wma)\*1\*2
  - Bit rate: 48 kbps – 192 kbps (Supports variable bit rate (VBR))\*3
  - Sampling frequency\*4: 44.1 kHz
- MP3 (.mp3)\*1\*2
  - Bit rate: 48 kbps – 320 kbps (Supports variable bit rate (VBR))\*3
  - Sampling frequency\*4: 32 kHz, 44.1 kHz, 48 kHz
- AAC (.m4a)\*1\*2
  - Bit rate: 40 kbps – 320 kbps (Supports variable bit rate (VBR))\*3
  - Sampling frequency\*4: 8 kHz – 48 kHz
  - Bit per sample (Quantization bit): 16 bits
- FLAC (.flac)\*1\*6
  - Sampling frequency\*4: 8 kHz – 48 kHz
  - Bit per sample (Quantization bit): 16 bits
- WAV (.wav)\*1
  - Sampling frequency\*4: 8 kHz – 48 kHz
  - Bit per sample (Quantization bit): 16 bits, 24 bits
- Xvid (.avi)
  - Video codec: MPEG-4 Advanced Simple Profile
  - Audio codec: MP3 (MPEG-1 Layer3)
  - Bit rate: Max. 4 Mbps
  - Frame rate: Max. 30 fps (30p/60i)
  - Resolution: Max. 1280 × 720\*5
- MPEG-4 (.mp4)
  - Video codec: MPEG-4 Advanced Simple Profile, AVC Baseline Profile
  - Audio codec: AAC
  - Bit rate: Max. 4 Mbps
  - Frame rate: Max. 30 fps (30p/60i)
  - Resolution: Max. 1280 × 720\*5
- WMV (.wmv, .avi)\*1
  - Video codec: WMV3, WVC1
  - Audio codec: MP3, WMA
  - Bit rate: Max. 6 Mbps
  - Frame rate: Max. 30 fps
  - Resolution: Max. 720 × 480\*5
- MKV (.mkv)
  - Video codec: MPEG-4 Advanced Simple Profile, AVC Baseline Profile
  - Audio codec: MP3, AAC
  - Bit rate: Max. 5 Mbps
  - Frame rate: Max. 30 fps
  - Resolution: Max. 1280 × 720\*5

\*1 Copyright-protected files and multi-channel audio files cannot be played back.

\*2 DRM (Digital Rights Management) files cannot be played back.

\*3 Non-standard bit rates or non-guaranteed bit rates are included depending on the sampling frequency.

\*4 Sampling frequency may not correspond to all encoders.

\*5 These numbers indicate the maximum resolution of playable video and do not indicate the player's display resolution. The display resolution is 800 × 480.

\*6 Displaying the tag information is not supported.

### Note

Some files may not be played back even though their file formats are supported by the unit.

## About iPhone

- For details on compatible iPhone models, visit the support site on the back cover.
- Use of the Made for Apple badge means that an accessory has been designed to connect specifically to the Apple product(s) identified in the badge, and has been certified by the developer to meet Apple performance standards. Apple is not responsible for the operation of this device or its compliance with safety and regulatory standards. Please note that the use of this accessory with an Apple product may affect wireless performance.

## Maintenance

### Replacing the lithium battery (CR2025) of the remote commander

When the battery becomes weak, the range of the remote commander becomes shorter.

#### CAUTION

Danger of explosion if battery is incorrectly replaced. Replace only with the same or equivalent type.

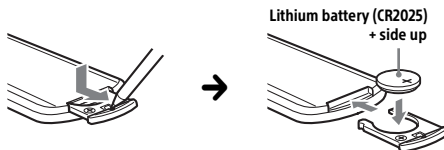

#### Note on the lithium battery

Keep the lithium battery out of the reach of children. Should the battery be swallowed, immediately consult a doctor.

# Specifications

**FOR THE CUSTOMERS IN THE USA. NOT APPLICABLE IN CANADA, INCLUDING IN THE PROVINCE OF QUEBEC.**

## AUDIO POWER SPECIFICATIONS



CTA2006 Standard  
Power Output: 20 Watts RMS  $\times$  4 at 4 Ohms  $<$  1% THD+N  
SN Ratio: 80 dBA (reference: 1 Watt into 4 Ohms)

## Monitor section

Display type: Wide LCD color monitor  
Dimensions: 6.95 in/176 mm  
System: TFT active matrix  
Number of pixels:  
1,152,000 pixels (800  $\times$  3 (RGB)  $\times$  480)  
Color system:  
PAL/NTSC automatic select for CAMERA IN terminal

## Tuner section

**FM**  
Tuning range: 87.5 MHz – 107.9 MHz  
Usable sensitivity: 7 dBf  
Signal-to-noise ratio: 70 dB (mono)  
Separation at 1 kHz: 45 dB

**AM**  
Tuning range: 530 kHz – 1,710 kHz  
Sensitivity: 32  $\mu$ V

## USB player section

Interface: USB (Hi-speed)  
Maximum current: 1.5 A

## Wireless communication

Communication System:  
BLUETOOTH Standard version 3.0  
Output:  
BLUETOOTH Standard Power Class 2  
(Max. +4 dBm)  
Maximum communication range\*1:  
Line of sight approx. 10 m (33 ft)  
Frequency band:  
2.4 GHz band (2.4000 GHz – 2.4835 GHz)  
Modulation method: FHSS

Compatible BLUETOOTH Profiles\*2:  
A2DP (Advanced Audio Distribution Profile) 1.3  
AVRCP (Audio Video Remote Control Profile) 1.3  
HFP (Handsfree Profile) 1.6  
PBAP (Phone Book Access Profile) 1.1  
Corresponding codec: SBC, AAC

- \*1 The actual range will vary depending on factors such as obstacles between devices, magnetic fields around a microwave oven, static electricity, reception sensitivity, antenna (aerial)'s performance, operating system, software application, etc.  
\*2 BLUETOOTH standard profiles indicate the purpose of BLUETOOTH communication between devices.

## Power amplifier section

Outputs: Speaker outputs  
Speaker impedance: 4  $\Omega$  – 8  $\Omega$   
Maximum power output: 55 W  $\times$  4 (at 4  $\Omega$ )

## General

Power requirements: 12 V DC car battery  
(negative ground (earth))  
Rated current consumption: 10 A  
Dimensions:  
Approx. 178 mm  $\times$  100 mm  $\times$  139 mm  
(7 1/8 in  $\times$  4 in  $\times$  5 1/2 in) (w/h/d)  
Mounting dimensions:  
Approx. 182 mm  $\times$  111 mm  $\times$  120 mm  
(7 1/4 in  $\times$  4 3/8 in  $\times$  4 3/4 in) (w/h/d)  
Mass: Approx. 1.1 kg (2 lb 7 oz)  
Package contents:

- Main unit
- Parts for installation and connections
- Remote commander (1): RM-X170
- Microphone (1)
- Cable for steering wheel remote input: RC-SR1

Ask the dealer for detailed information.

Design and specifications are subject to change without notice.

## Copyrights

The Bluetooth® word mark and logos are registered trademarks owned by the Bluetooth SIG, Inc. and any use of such marks by Corporation is under license. Other trademarks and trade names are those of their respective owners.

Windows Media is either a registered trademark or trademark of Microsoft Corporation in the United States and/or other countries.

This product is protected by certain intellectual property rights of Microsoft Corporation. Use or distribution of such technology outside of this product is prohibited without a license from Microsoft or an authorized Microsoft subsidiary.

Apple, iPhone, and Lightning are trademarks of Apple Inc., registered in the U.S. and other countries. Apple CarPlay is a trademark of Apple Inc.

IOS is a trademark or registered trademark of Cisco in the U.S. and other countries and is used under license.

Android, Android Auto, Google and Google Play are trademarks of Google LLC.

THIS PRODUCT IS LICENSED UNDER THE MPEG-4 VISUAL PATENT PORTFOLIO LICENSE FOR THE PERSONAL AND NON-COMMERCIAL USE OF A CONSUMER FOR DECODING VIDEO IN COMPLIANCE WITH THE MPEG-4 VISUAL STANDARD ("MPEG-4 VIDEO") THAT WAS ENCODED BY A CONSUMER ENGAGED IN A PERSONAL AND NONCOMMERCIAL ACTIVITY AND/OR WAS OBTAINED FROM A VIDEO PROVIDER LICENSED BY MPEG LA TO PROVIDE MPEG-4 VIDEO. NO LICENSE IS GRANTED OR SHALL BE IMPLIED FOR ANY OTHER USE.

ADDITIONAL INFORMATION INCLUDING THAT RELATING TO PROMOTIONAL, INTERNAL AND COMMERCIAL USES AND LICENSING MAY BE OBTAINED FROM MPEG LA, LLC. SEE [HTTP://WWW.MPEGLA.COM](http://www.mpegla.com)

THIS PRODUCT IS LICENSED UNDER THE AVC PATENT PORTFOLIO LICENSE FOR THE PERSONAL AND NON-COMMERCIAL USE OF A CONSUMER TO (i) ENCODE VIDEO IN COMPLIANCE WITH THE AVC STANDARD ("AVC VIDEO") AND/OR

(ii) DECODE AVC VIDEO THAT WAS ENCODED BY A CONSUMER ENGAGED IN A PERSONAL AND NON-COMMERCIAL ACTIVITY AND/OR WAS OBTAINED FROM A VIDEO PROVIDER LICENSED TO PROVIDE AVC VIDEO. NO LICENSE IS GRANTED OR SHALL BE IMPLIED FOR ANY OTHER USE. ADDITIONAL INFORMATION MAY BE OBTAINED FROM MPEG LA, L.L.C. SEE [HTTP://WWW.MPEGLA.COM](http://www.mpegla.com)

THIS PRODUCT IS LICENSED UNDER THE AVC PATENT PORTFOLIO LICENSE AND VC-1 PATENT PORTFOLIO LICENSE FOR THE PERSONAL AND NON-COMMERCIAL USE OF A CONSUMER TO DECODE VIDEO IN COMPLIANCE WITH THE AVC STANDARD ("AVC VIDEO") AND/OR THE VC-1 STANDARD ("VC-1 VIDEO") THAT WAS ENCODED BY A CONSUMER ENGAGED IN A PERSONAL AND NONCOMMERCIAL ACTIVITY AND/OR WAS OBTAINED FROM A VIDEO PROVIDER LICENSED TO PROVIDE AVC VIDEO AND/OR VC-1 VIDEO. NO LICENSE IS GRANTED OR SHALL BE IMPLIED FOR ANY OTHER USE. ADDITIONAL INFORMATION MAY BE OBTAINED FROM MPEG LA, L.L.C. SEE [HTTP://WWW.MPEGLA.COM](http://www.mpegla.com)

All other trademarks are trademarks of their respective owners.

## Troubleshooting

The following checklist will help you remedy problems you may encounter with your unit. Before going through the checklist below, check the connection and operating procedures.

For details on using the fuse and removing the unit from the dashboard, see "Connection/Installation".

If the problem is not solved, visit the support site on the back cover.

### General

#### **There is no beep sound.**

→ An optional power amplifier is connected and you are not using the built-in amplifier.

#### **The fuse has blown.**

#### **The unit makes noise when the position of the ignition is switched.**

→ The leads are not matched correctly with the car's accessory power connector.

#### **The display disappears from/does not appear on the monitor.**

→ The monitor off function is activated.  
– Touch anywhere on the display to turn the display back on.

#### **Menu items cannot be selected.**

→ Unavailable menu items are displayed in gray.

#### **The USB functions do not work properly.**

→ Do not use a USB extension cable as it may cause deterioration of signal quality.  
– Use a shorter USB cable when connecting the USB device, or replace the USB cable with a new one.

#### **The unit cannot be operated.**

→ Press and hold HOME for more than 10 seconds to restart the unit. For your safety, do not restart the unit while you are driving.

### Touch panel operation

#### **The touch panel does not react to your touch correctly.**

→ Touch one part of the touch panel at a time. If two or more parts are touched simultaneously, the touch panel will not react correctly.  
→ Calibrate the touch panel of the display. → Touch the pressure sensitive panel firmly.

#### **Multi-touch is not recognized.**

→ Multi-touch operation is not supported on this unit.

## Radio reception

**The radio reception is poor.**

**Static noise occurs.**

- Connect the antenna (aerial) firmly.

## RDS

**PTY displays [PTY not found].**

- The current station is not an RDS station, or the radio reception is poor.

## Picture

**There is no picture/picture noise occurs.**

- A connection has not been made correctly.
- Check the connection between this unit and other equipment and set the input selector of the equipment to the source corresponding to this unit.
- Installation is not correct.
  - Install the unit at an angle of less than 30° in a sturdy part of the car.
- The parking cord (light green) is not connected to the parking brake switch cord, or the parking brake is not applied.

**The picture does not fit in the screen.**

- The aspect ratio is fixed on the playback source.

## Sound

**There is no sound/sound skips/sound cracks.**

- A connection has not been made correctly.
- Check the connection between this unit and the connected equipment and set the input selector of the equipment to the source corresponding to this unit.
- Installation is not correct.
  - Install the unit at an angle of less than 30° in a sturdy part of the car.
- The unit is in pause/reverse/fast-forward mode.
- The settings for the outputs are not made correctly.
- The volume is too low.
- The ATT function is activated.
- The format is not supported.
  - Check if the format is supported by this unit.

**Sound is noisy.**

- Keep cords and cables away from each other.

## USB playback

**Items cannot be played.**

- Reconnect the USB device.

**The USB device takes longer to play.**

- The USB device contains large-sized files or files with a complicated tree structure.

**Audio files cannot be played.**

- USB devices formatted with file systems other than FAT12, FAT16, FAT32 or exFAT are unsupported.\*

\* This unit supports FAT12, FAT16, FAT32 and exFAT, but some USB device may not support all of these. For details, refer to the operating instructions of each USB device or contact the manufacturer.

## BLUETOOTH function

**The other BLUETOOTH device cannot detect this unit.**

- Set [Bluetooth Connection] to [ON].
- While connecting to a BLUETOOTH device, this unit cannot be detected by another device. Terminate the current connection and search for this unit from the other device.
- Depending on your smartphone or cellular phone, you may need to delete this unit from the history of the connected smartphone or cellular phone then pair them again.

**Connection is not possible.**

- Check the pairing and connection procedures in the manual of the other device, etc., and perform the operation again.

**The name of the detected device does not appear.**

- Depending on the status of the other device, it may not be possible to obtain the name.

**There is no ringtone.**

- Raise the volume while receiving a call.

**The talker's voice volume is low.**

- Raise the volume during a call.

**The other party says that the volume is too low or high.**

- Adjust the [MIC Gain] level.

**Echo or noise occurs during call conversations.→**

Reduce the volume.

- Set [Speech Quality] to [Mode 1] or [Mode 2].
- If ambient noise other than the phone call sound

is loud, try reducing this noise.

- Shut the window if road noise is loud.
- Lower the air conditioner if the air conditioner is loud.

---

**The phone sound quality is poor.**

- Phone sound quality depends on reception conditions of the cellular phone.
  - Move your car to a place where you can enhance the cellular phone's signal if the reception is poor.

---

**The volume of the connected BLUETOOTH device is low or high.**

- Volume level will differ depending on the BLUETOOTH device.
  - Reduce the volume level differences between this unit and the BLUETOOTH device.

---

**The sound skips during audio streaming or the BLUETOOTH connection fails.**

- Reduce the distance between the unit and the BLUETOOTH device.
- If the BLUETOOTH device is stored in a case which interrupts the signal, remove the case while using the device.
- Several BLUETOOTH devices or other devices (e.g. ham radio devices) which emit radio waves are used nearby.
  - Turn off the other devices.
  - Increase the distance between the unit and other devices.
- Playback sound stops momentarily when this unit is connecting to a cellular phone. This is not a malfunction.

---

**The connected BLUETOOTH device cannot be controlled during audio streaming.**

- Check that the connected BLUETOOTH device supports AVRCP.

---

**Some functions do not work.**

- Check that the connecting device supports the functions in question.

---

**A call is answered unintentionally.**

- The connecting phone is set to start a call automatically.
- [Auto Answer] of this unit is set to [ON].

---

**Pairing failed due to time out.**

- Depending on the connecting device, the time limit for pairing may be short. Try completing the pairing within the time.

---

**Cannot pair.**

- The unit may not be able to pair with a previously paired BLUETOOTH device after initializing the unit if the pairing information of the unit is on the BLUETOOTH device. In this case, delete the pairing information of the unit from the BLUETOOTH device, and then pair them again.

---

**The BLUETOOTH function cannot be operated.**

- Turn the ignition off. Wait for a while, then turn the ignition to the ACC position.

---

**No sound is output from the car speakers during a handsfree call.**

- If the sound is output from the cellular phone, set the cellular phone to output the sound from the car speakers.

---

**Apple CarPlay****The Apple CarPlay icon does not appear on the HOME screen.**

- Your iPhone is not compatible with Apple CarPlay.
  - Refer to the compatibility list on the support site on the back cover.
- Disconnect your iPhone from the USB port and reconnect it again.
- Apple CarPlay may not be available in your country or region.
- Make sure a certified Lightning cable is used to connect your iPhone and the unit.

---

**Android Auto****The Android Auto icon does not appear on the HOME screen.**

- Check your Android phone and accept the disclaimers and permission requests required to use Android Auto on your Android phone.
- There is no Android Auto application installed on your Android phone.
  - Download and install the Android Auto application onto your Android phone.
- Your Android phone is not compatible with Android Auto.
  - Android phone with Android 5.0 or higher is required. Refer to the compatibility list on the support site on the back cover.
- Disconnect your Android phone from the USB port and reconnect it again.
- Android Auto may not be available in your country or region.

---

# Messages

## General

### Cannot play this content.

- The currently selected content cannot be played back, or skipped to the next one.
  - The content is not in a supported file format. Check supported file formats.

### Device no response

- The unit does not recognize the connected USB device.
  - Reconnect the USB device.
  - Check that the USB device is supported by the unit.

### No Playable Data

- The USB device has no playable data.
  - Load music data/files into the USB device.

### Overcurrent caution on USB.

- The USB device is overloaded.
  - Disconnect the USB device.
  - Indicates that the USB device is out of order, or an unsupported device is connected.

### USB device not supported

- For details on the compatibility of your USB device, visit the support site on the back cover.

### USB hub not supported

- USB hubs are not supported on this unit.

## BLUETOOTH

### Bluetooth device is not found.

- The unit cannot detect a connectable BLUETOOTH device.
  - Check the BLUETOOTH setting of the connecting device.
- No device is in the list of registered BLUETOOTH devices.
  - Perform pairing with a BLUETOOTH device.

### Handsfree device is not available.

- A cellular phone is not connected.
  - Connect a cellular phone.

If these solutions do not help improve the situation, contact a service center.

## Connection/Installation

### Cautions

- Do not install this unit in a car that has no ACC position. The display of the unit does not turn off even after turning the ignition off, and this causes battery drain.
- **Run all ground (earth) leads to a common ground (earth) point.**
- Do not get the leads trapped under a screw or caught in moving parts (e.g., seat railing).
- Before making connections, turn the car ignition off to avoid short circuits.
- Connect the **yellow** and **red** power supply leads only after all other leads have been connected.
- Be sure to insulate any loose unconnected leads with electrical tape for safety.

### Precautions

- Choose the installation location carefully so that the unit will not interfere with normal driving operations.
- Avoid installing the unit in areas subject to dust, dirt, excessive vibration, or high temperature, such as in direct sunlight or near heater ducts.
- Use only the supplied mounting hardware for a safe and secure installation.

#### Note on the power supply lead (yellow)

When connecting this unit in combination with other stereo components, the amperage rating of the car circuit to which the unit is connected must be higher than the sum of each component's fuse amperage rating.

#### Mounting angle adjustment

Adjust the mounting angle to less than 30°.

## Parts List for Installation

### ① Power supply leads

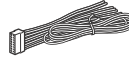

### ② Mounting screws (5 × max. 9 mm (7/32 × max. 3/8 in))



### ③ Microphone

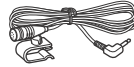

### ④ Connection cable RC-SR1



- This parts list does not include all the package contents.
- Use the connection cable RC-SR1 for the steering wheel remote control as necessary. For details, see "Using the wired remote control".
- Accessory type and quantity may vary depending on the model.
- The image shown here is for illustrative purposes only and may be subject to change.



# Connection

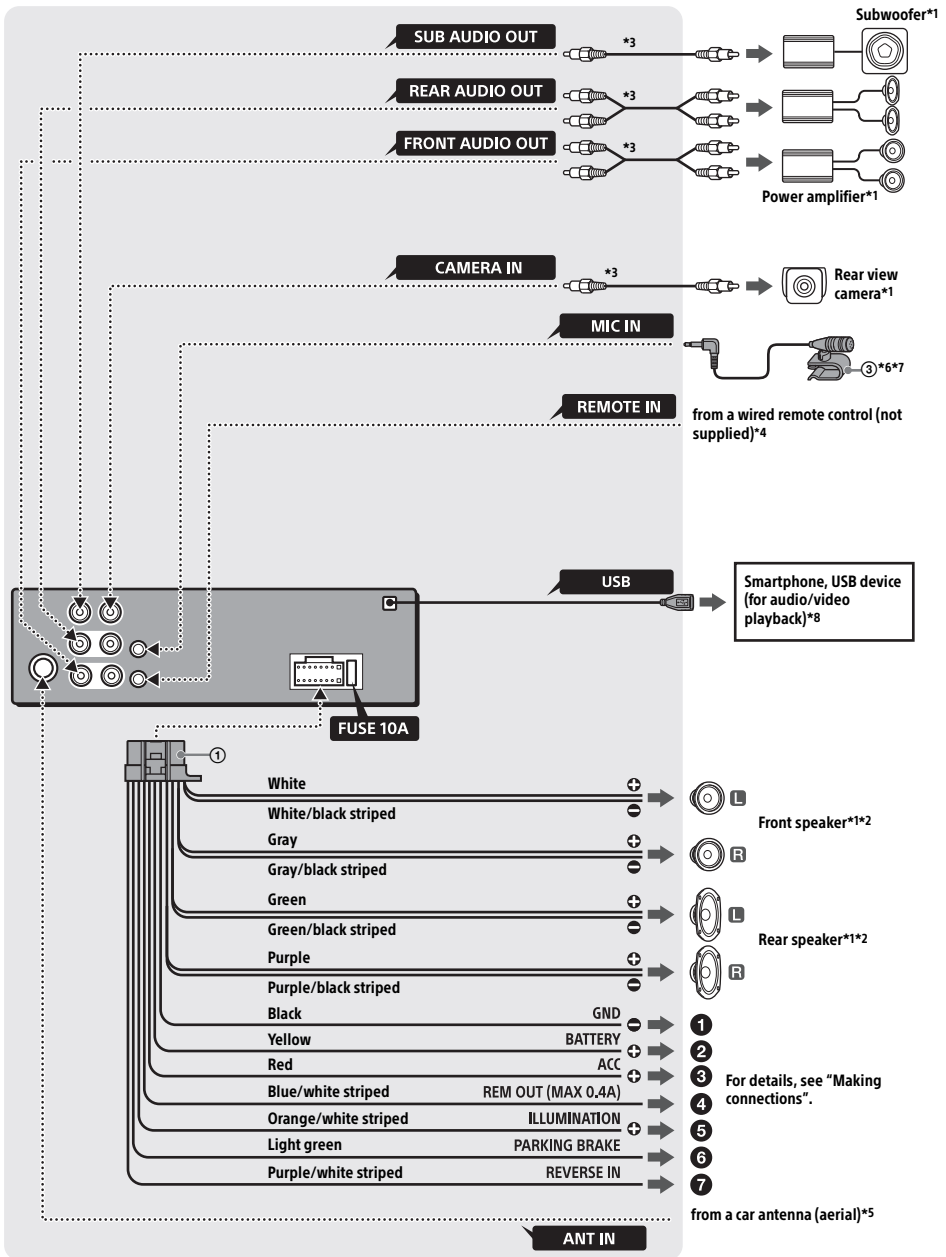

• The cables mentioned in this guide is not supplied with your unit.

• The images shown here are for illustrative purposes only and may be subject to change, the actual descriptions of control panel and their locations may vary depending on the model.

- \*1 Not supplied
- \*2 Speaker impedance:  $4 \Omega - 8 \Omega \times 4$
- \*3 RCA pin cord (not supplied)
- \*4 Depending on the type of car, use an adaptor for a wired remote control (not supplied).  
For details on using the wired remote control, see "Using the wired remote control".  
When using the steering wheel remote control, use the connection cable RC-SR1 as necessary.
- \*5 Depending on the type of car, use an adaptor (not supplied) if the antenna (aerial) connector does not fit.
- \*6 Whether in use or not, route the microphone input cord so it does not interfere with driving operations. Secure the cord with a clamp, etc., if it is installed around your feet.
- \*7 For details on installing the microphone, see "Installing the microphone".
- \*8 Do not use a USB extension cable.

## Making connections

- 1 To a common ground (earth) point**  
First connect the black ground (earth) lead then connect the yellow and red power supply leads.
- 2 To the +12 V power terminal which is energized at all times**  
Be sure to first connect the black ground (earth) lead to a common ground (earth) point.
- 3 To the +12 V power terminal which is energized when the ignition switch is set to the accessory position**  
Be sure to first connect the black ground (earth) lead to a common ground (earth) point.
- 4 To the power antenna (aerial) control lead or the power supply lead of the antenna (aerial) booster**  
It is not necessary to connect this lead if there is no power antenna (aerial) or antenna (aerial) booster, or with a manually-operated telescopic antenna (aerial).  
**To AMP REMOTE IN of an optional power amplifier**  
This connection is only for amplifiers and a power antenna (aerial). Connecting any other system may damage the unit.  
**Note**  
It will take about 10 seconds to shut down the output of REM OUT after the unit is turned off.
- 5 To a car's illumination signal**  
Be sure to first connect the black ground (earth) lead to a common ground (earth) point.

### 6 To the parking brake switch cord

The mounting position of the parking brake switch cord depends on your car. Be sure to connect the parking brake lead (light green) of the power supply leads ① to the parking brake switch lead.

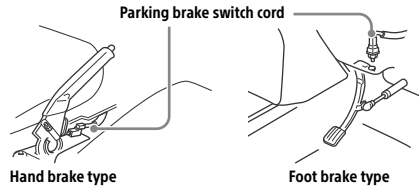

### 7 To the +12 V power terminal of the car's rear lamp lead (only when connecting the rear view camera)

## Memory hold connection

When the yellow power supply lead is connected, power will always be supplied to the memory circuit even when the ignition switch is turned off.

## Speaker connection

- Before connecting the speakers, turn the unit off.
- Use speakers with an impedance of  $4 \Omega$  to  $8 \Omega$  and with adequate power handling capacities to avoid damage.

## Cautions

- It is extremely dangerous if the cord becomes wound around the steering column or gearstick. Be sure to keep it and other parts from interfering with your driving operations.
- If airbags or any other shock-absorbing equipment are in your car, contact the store where you purchased this unit or the car dealer before installation.

## Notes

- When mounting on the dashboard, remove the visor clip carefully from the microphone ③, then attach the flat-mount base ④ to the microphone ③.

## Using the wired remote control

### When using the steering wheel remote control

Installation of the connection cable RC-SR1 ④ is required before use.

- 1 To enable the steering wheel remote control, select [General] → [Steering Control] → [Custom] → [ ] t o make the registration.  
When the registration is complete, the steering wheel remote control becomes available.

### Notes on installing the connection cable RC-SR1 ④

- Refer to the support site on the back cover for details then connect each lead properly to the appropriate leads. Making an improper connection may damage the unit.
- Consulting the dealer or an experienced technician for help is recommended.

### When using the wired remote control

- 1 To enable the wired remote control, set [Steering Control] in [General] to [Preset].

## Using the rear view camera

Installation of the rear view camera (not supplied) is required before use.

The picture from a rear view camera connected to the CAMERA IN terminal is displayed when:

- the back lamp of your car lights up (or the shift lever is set to the R (reverse) position).
- you press HOME, then touch [Rear Camera].

## Installation

### Mounting kit not included the unit in a Japanese car

You may not be able to install this unit in some Japanese cars. In such a case, contact a service center.

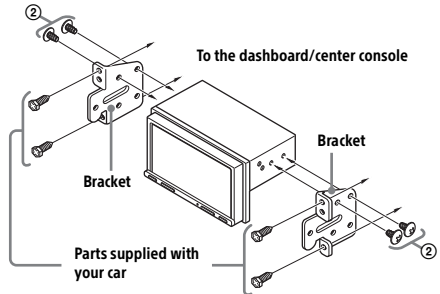

When mounting this unit to the preinstalled brackets of your car, use the mounting screws ② in the appropriate screw holes based on your car: T for TOYOTA and N for NISSAN.

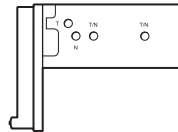

### Note

To prevent a malfunction, install only with the mounting screws ②.

## Fuse replacement

When replacing the fuse, be sure to use one matching the amperage rating stated on the original fuse. If the fuse blows, check the power connection and replace the fuse. If the fuse blows again after replacement, there may be an internal malfunction. In such a case, contact a service center.

