

SAFETY INFORMATION
IMPORTANT SAFETY INFORMATION
READ ALL INSTRUCTIONS BEFORE USING THE APPLIANCE

▲WARNING For your safety, the information in this manual must be followed to minimize the risk of fire, electric shock or personal injury.

- Use this appliance only for its intended purpose as described in this Owner's Manual.
- This air conditioner must be properly installed in accordance with the Installation Instructions before it is used.
- Never unplug your air conditioner by pulling on the power cord. Always grip plug firmly and pull straight out from the receptacle.
- Replace immediately all electric service cords that have become frayed or otherwise damaged. A damaged power supply cord must be replaced with a new power supply cord obtained from the manufacturer and not repaired. Do not use a cord that shows cracks or abrasion damage along its length or at either the plug or connector end.
- Turn the unit OFF and unplug your air conditioner before cleaning.
- For your safety...do not store or use combustible materials, gasoline or other flammable vapors or liquids in the vicinity of this or any other appliance.
- If the receptacle does not match the plug, the receptacle must be changed out by a qualified electrician.

▲WARNING Risk of Fire or Explosion. This unit contains flammable refrigerant. Additional safety precautions must be followed.

- Do not use means to accelerate the defrosting process or to clean, other than those recommended by the manufacturer.
- The appliance shall be stored in a room without continuously operating ignition sources (for example: open flames, an operating gas appliance or an operating electric heater).
- Do not pierce or burn refrigerant tubing. Be aware that refrigerants may not contain an odor.
- Keep ventilation openings clear of obstruction.
- When handling, installing, and operating the appliance, care should be taken to avoid damage to the refrigerant tubing.
- Do not drill holes in the unit.
- Maintenance, cleaning, and service should only be performed by technicians properly trained and qualified in the use of flammable refrigerants.
- GE Appliances does not support any servicing of the air conditioner.
- Dispose of air conditioner in accordance with Federal and Local Regulations. Flammable refrigerants require special disposal procedures. Contact a service center.

▲WARNING USE OF EXTENSION CORDS

RISK OF FIRE. Could cause serious injury or death.

- DO NOT use an extension cord with this Window Air Conditioner.

HOW TO CONNECT ELECTRICITY

Do not, under any circumstances, cut or remove the third (ground) prong from the power cord. For personal safety, this appliance must be properly grounded.

DO NOT use an adapter plug with this appliance.

The power cord of this appliance is equipped with a 3-prong (grounding) plug which mates with a standard 3-prong (grounding) wall outlet to minimize the possibility of electric shock hazard from this appliance.

Power cord includes a current interrupter device. A test and reset button is provided on the plug case. The device should be tested on a periodic basis by first pressing the **TEST** button and then the **RESET** button while plugged into the outlet. If the **TEST** button does not trip or if the **RESET** button will not stay engaged, discontinue use of the air conditioner and contact a qualified service technician.

- DO NOT use surge protectors or multi-outlet adaptors with this Window Air Conditioner.

Have the wall outlet and circuit checked by a qualified electrician to make sure the outlet is properly grounded.

Where a 2-prong wall outlet is encountered, it is your personal responsibility and obligation to have it replaced with a properly grounded 3-prong wall outlet.

The air conditioner should always be plugged into its own individual electrical outlet which has a voltage rating that matches the rating plate.

This provides the best performance and also prevents overloading house wiring circuits which could cause a fire hazard from overheated wires.

See the Installation Instructions, **Electrical Requirements** section for specific electrical connection requirements.

READ AND SAVE THESE INSTRUCTIONS

CONTROLS

Features and appearance will vary.

Lights below the touch pads on the air conditioner control panel indicate the selected settings.

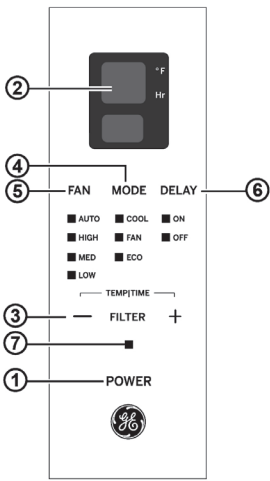

Air Conditioner Controls

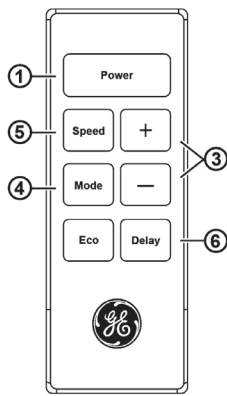

Remote Control

Controls

- 1. Power Pad**
Turns air conditioner on and off. When turned on, the display will show the Set temperature.
- 2. Display**
Shows the Set temperature or time remaining on the Delay timer. Shows the Set temperature while setting the temperature in Cool or Eco modes.
- 3. Temp and Delay Increase + / Decrease - Pads**
Use to set temperature or delay time. Temperature can be set in Cool and Eco mode.
- 4. Mode Pad**
Use to set the air conditioner to Fan Only, Cool, or Eco mode.
- 5. Fan Speed Pad**
In Cool, Eco mode:
Use to set the fan speed to Auto, High, Med or Low on the unit.
In Fan Only mode:
Use to set the fan speed to High, Med, or Low on the unit.

6. Delay Pad

Delay ON—When the air conditioner is off, it can be set to automatically come on in 1 to 24 hours at its previous mode and fan settings.

Delay OFF—When the air conditioner is on, it can be set to automatically turn off in 1 to 24 hours.

How to set:

Press the **Delay 1-24hr** pad on the unit or the remote control. Each touch of the **Increase + / Decrease -** pads on the unit or the remote control will set the timer in 1-hour intervals.

To review the remaining time on the **Delay 1-24hr** timer, press the **Delay 1-24hr** pad on the unit or the remote control. Use the **Increase + / Decrease -** pads on the unit or on the remote control to set a new time if desired.

To cancel the timer, press **Decrease -** pad on the unit or the remote control until the set time is zero. After 3 seconds the light on the **Delay 1-24** hour pad goes off.

7. Filter Reset Pad

This feature automatically notifies you that the air filter must be cleaned. The indicator light will come on after 250 hours of operation. Clean the air filter, place it back in the front panel, and press the Filter Reset pad. The light will go off.

USING THE AIR CONDITIONER

Do Not Operate in Freezing Outdoor Conditions

This cool-only air conditioner was not designed for freezing outdoor conditions. It must not be used when the outdoor temperature is below freezing (32°F).

Remote Control

- To ensure proper operation, aim the remote control at the signal receiver on the air conditioner.
- The remote control signal has a range of up to 20 feet.
- Make sure nothing is between the air conditioner and the remote control that could block the signal.
- Make sure batteries are fresh and installed correctly as indicated on the remote control.

Cool Mode

Use the Cool mode at **Low, Med, High** or **Speed** for cooling. Use the **Temperature Increase + / Decrease -** pads to set the desired temperature between 64°F and 86°F in 1°F increments.

An electronic thermostat is used to maintain the room temperature. The compressor will cycle on and off to keep the room at the set level of comfort. Set the thermostat at a lower number and the indoor air will become cooler. Set the thermostat at a higher number and the indoor air will become warmer.

NOTE: If the air conditioner is off and is then turned on while set to a **Cool** setting or if turned from a fan setting to a **Cool** setting, it may take approximately 3 minutes for the compressor to start and cooling to begin.

Cooling Descriptions

For Normal Cooling—Select the **Cool** mode and **High** or **Med** fan with a middle set temperature.

For Maximum Cooling—Select the **Cool** mode and **High** fan with a lower set temperature.

For Quieter and Nighttime Cooling—Select the **Cool** mode and **Low** fan with a middle set temperature.

Eco

Controls the fan.

ON—The fan will cycle on and off with the compressor. This may result in wider variations of room temperature and humidity. **NOTE:** the fan may continue to run for a short time or may pulse intermittently after the compressor cycles off to sample the room air.

OFF—The fan runs all the time, while the compressor cycles on and off.

Fan Only Mode

Use the Fan Only Mode at Low, Med or High fan speed to provide air circulation and filtering without cooling.

Since fan-only settings do not provide cooling, a Set temperature cannot be entered. The room temperature will appear in the display.

Auto Fan Speed

Set to **Auto** for the fan speed to automatically set to the speed needed to provide optimum comfort settings with the set temperature.

If the room needs more cooling, the fan speed will automatically increase. If the room needs less cooling, the fan speed will automatically decrease.

Air Direction

Use the lever to adjust the air direction left to right.

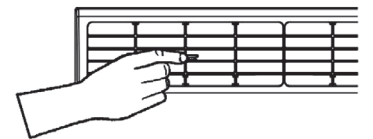

CARE AND CLEANING

Grille and Case

Turn the air conditioner off and remove the plug from the wall outlet before cleaning.

To clean, use water and a mild detergent. Do not use bleach or abrasives.

Air Filter

The air filter behind the front grille should be checked and cleaned at least every 30 days or more often if necessary.

To remove:

Slide the filter from the left side of the unit. Remove the filter.

Clean the filter with warm, soapy water. Rinse and let the filter dry before replacing it. Do not clean the filter in a dishwasher.

▲CAUTION DO NOT operate the air conditioner without a filter because dirt and lint will clog it and reduce performance.

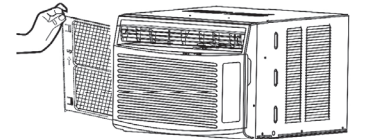

Outdoor Coils

The coils on the outdoor side of the air conditioner should be checked regularly. If they are clogged with dirt or soot, they may be professionally cleaned.

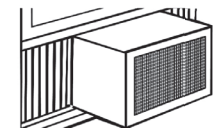

How to Insert the Batteries in the Remote Control (Batteries Not Included)

1. Remove the battery cover by sliding it according to the arrow direction.
2. Insert new batteries, making sure that the (+) and (-) of battery are installed correctly.
3. Reattach the cover by sliding it back into position.

NOTES:

- Use 2 "AAA" (1.5 volt) batteries. Do not use rechargeable batteries.
- Remove the batteries from the remote control if the system is not going to be used for a long time.
- Do not mix old and new batteries. Do not mix standard (carbon-zinc) or rechargeable (ni-cad, ni-mh, etc) batteries.

Installation Instructions

BEFORE YOU BEGIN

Read these instructions completely and carefully.

- **IMPORTANT** — Save these instructions for local inspector's use.
- **IMPORTANT** — Observe all governing codes and ordinances.
- **Note to Installer** — Be sure to leave these instructions with the Consumer.
- **Note to Consumer** — Keep these instructions for future reference.
- **Skill level** — Installation of this appliance requires basic mechanical skills.
- **Completion time** — Approximately 1 hour
- We recommend that two people install this product.
- Proper installation is the responsibility of the installer.
- Product failure due to improper installation is not covered under the Warranty.
- You **MUST** use all supplied parts and use proper installation procedures as described in these instructions when installing this air conditioner.

ELECTRICAL REQUIREMENTS

These models require a 115/120-volt AC, 60-Hz grounded outlet protected with a 15-amp time-delay fuse or circuit breaker.

The 3-prong grounding plug minimizes the possibility of electric shock hazard. If the wall outlet you plan to use is only a 2-prong outlet, it is your responsibility to have it replaced with a properly grounded 3-prong wall outlet.

▲CAUTION

Do not, under any circumstances, cut or remove the third (ground) prong from the power cord.

Do not change the plug on the power cord of this air conditioner.

Aluminum house wiring may present special problems—consult a qualified electrician.

Power cord includes a current interrupter device. A test and reset button is provided on the plug case. The device should be tested on a periodic basis by first pressing the **TEST** button and then the **RESET** button while plugged into the outlet. If the **TEST** button does not trip or if the **RESET** button will not stay engaged, discontinue use of the air conditioner and contact a service center.

TOOLS YOU WILL NEED NOT INCLUDED

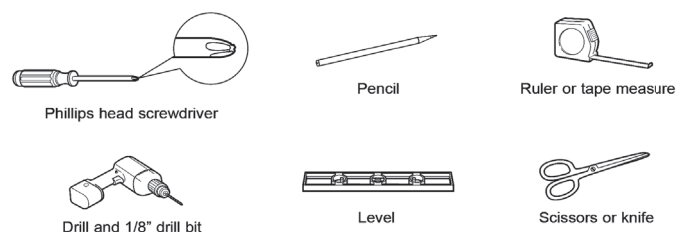

• The images shown here are for illustrative purposes only and may be subject to change, the actual descriptions of control panel and their locations may vary depending on the model.

• The remote control vary depend of model: The buttons on the remote control may have a different name or location than the remote control shows in this manual.

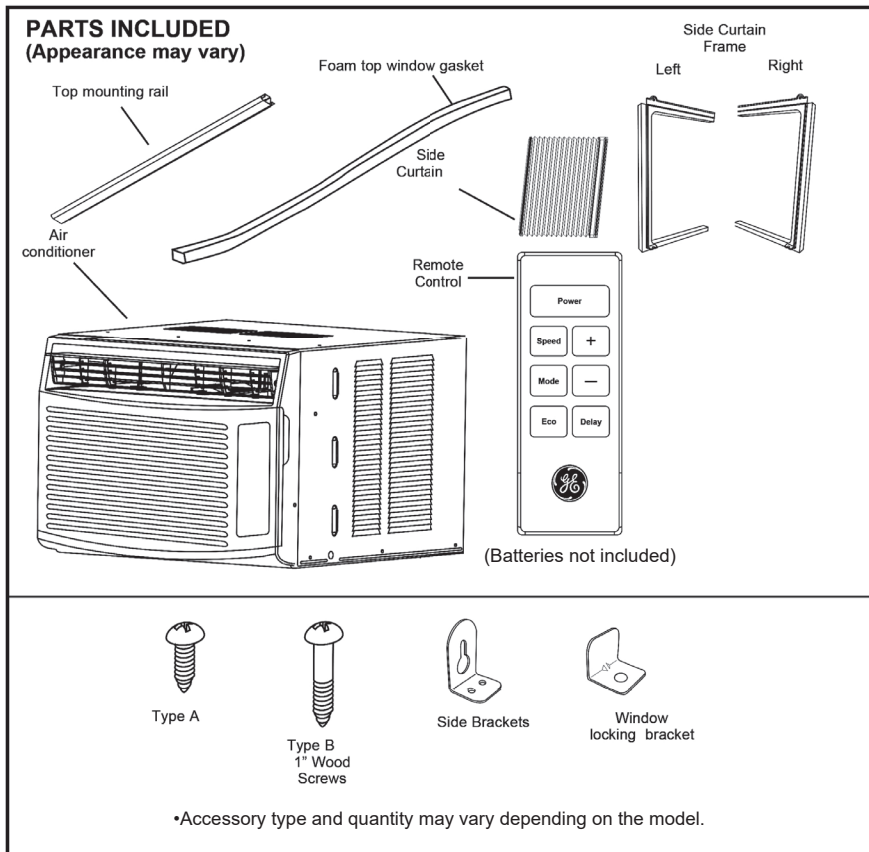

1. WINDOW REQUIREMENTS

- These instructions are for a standard double-hung window. You will need to modify them for other types of windows.
- The air conditioner can be installed without the side curtain panels if needed to fit in a narrow window. See the window opening dimensions.
- All supporting parts must be secured to firm wood, masonry or metal.
- The electrical outlet must be within reach of the power cord.
- Follow the dimensions in the table and illustration for your model.

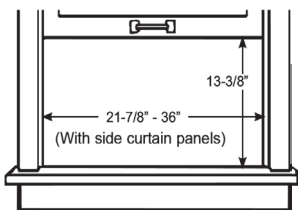

2. STORM WINDOW REQUIREMENTS

A storm window frame will not allow the air conditioner to tilt toward the outside, and will keep it from draining properly. To adjust for this, attach a piece of wood to the sill.

WOOD PIECES

WIDTH: 2"

LENGTH: Long enough to fit inside the window frame.

THICKNESS: To determine the thickness, place a piece of wood on the sill to make it 1/2" higher than the top of the storm window frame or the vinyl frame.

Attach securely with nails or screws provided by the installer.

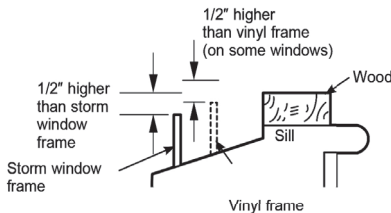

3. PREPARE THE AIR CONDITIONER

A. Install the top mounting rail with Type A screws from the outside of the case.

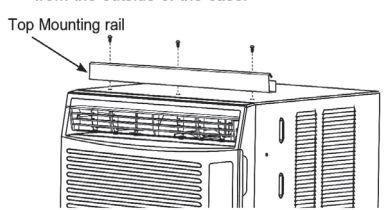

B. Slide the side curtain panels into the side panel rails.

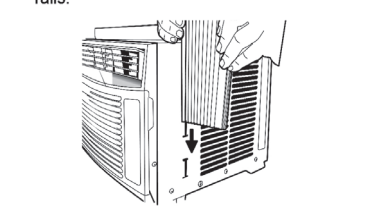

C. Slide left and right side curtain frames into top and bottom rails. Make sure that side curtains snap into side of the frames.

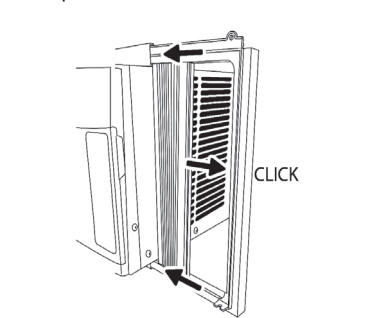

4. INSTALL THE AIR CONDITIONER IN THE WINDOW

A. Mark the center of the window. Set the air conditioner in the window so that it is centered. Place the air conditioner so that front edge of the bottom mounting rail is against the back edge of the sill.

B. Bring the window down so that the front edge of the top mounting is in front of the window. Make sure that the air conditioner is level or tilting slightly to the outside.

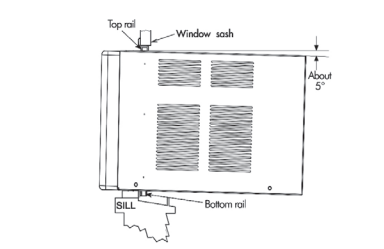

C. Extend the curtain panels until they fill the window. Mark the location of the holes in each corner. Use the drill and 1/8" drill bit to drill pilot holes. Use 4 type B screws to secure the side panels in place.

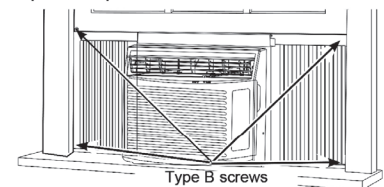

5. SECURE AIR CONDITIONER

A. Install the side bracket into the unit and into the window sill using two 1" wood screws provided. Repeat on other side.

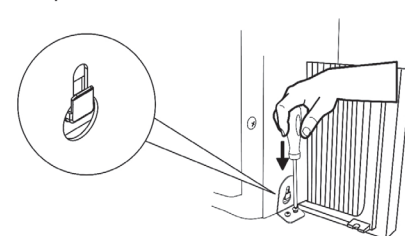

6. INSTALL WINDOW LOCK BRACKET AND FOAM TOP WINDOW GASKET

Use Type B Screw to install the window lock bracket on top of the bottom window.

CAUTION

To prevent broken glass or damage to windows, other similarly constructed windows, attach the window locking bracket to the window side jamb with one Type B screw.

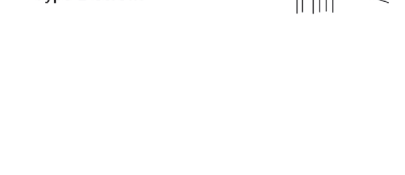

B. Cut the foam top window gasket to the window width.

C. Stuff the foam between the glass and the window to prevent air and insects from getting into the room.

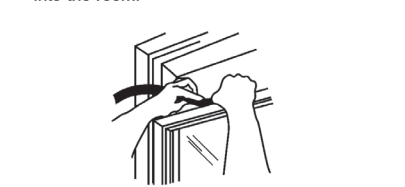

NOTE: If the gasket not supplied does not fit your window, obtain appropriate material locally to provide a proper installation seal.

TROUBLESHOOTING TIPS

Save time and money! Review the charts on the following.

Problem	Possible Cause	What To Do
Air conditioner does not start.	The unit is unplugged.	Make sure the air conditioner plug is pushed completely into the outlet.
	The fuse is blown/circuit breaker is tripped.	Check the house fuse/circuit breaker box and replace the fuse or reset the breaker.
	Power Failure.	The unit will automatically restart in the setting last used after the power is restored. There is a protective time delay (approximately 3 minutes) to prevent tripping of the compressor overload. For this reason, the unit may not start normal cooling for 3 minutes after it is turned back on.
Air conditioner does not cool as it should.	The current interrupter device is tripped.	Press RESET button located on the power cord plug. If the RESET button will not stay engaged, discontinue use of the air conditioner and contact a qualified service technician.
	Indoor airflow is restricted.	Make sure there are not curtains, blinds or furniture blocking the front of the air conditioner.
	The temp control may not be set properly.	Turn the temperature control to a higher number.
	The air filter is dirty.	Clean the filter at least every 30 days. See Care and Cleaning section.
	The room may have been hot.	When the air conditioner is first turned on, you need to allow time for the room to cool down.
Air conditioner freezing up	Cold air is escaping.	Check for open furnace registers and cold air returns.
	Cooling coils have iced up.	See "Air conditioner freezing up" below.
Air conditioner freezing up	Ice blocks the air flow and stops the air conditioner from cooling the room.	Set the mode control to High Fan or High Cool with the temperature setting as high as it can be set.
Water drips outside	Hot, humid weather.	This is normal.
Water drips inside	The air conditioner is not tilted to the outside.	For proper disposal, make sure the air conditioner slants slightly from the case front to the rear
Water collects in base pan	Moisture removed from air and drain into base pan.	This is normal for a short period in areas with little humidity; normal for a longer period in very humid areas.

Normal Operating Sounds

- You may hear a pinging noise caused by water being picked up and thrown against the condenser on rainy days or when the humidity is high. This design feature helps remove moisture and improve efficiency.
- You may hear the thermostat click when the compressor cycles on and off.
- Water will collect in the base pan during high humidity or on rainy days. The water may overflow and drip from the outdoor side of the unit.
- The fan may run even when the compressor does not.
- Water droplets being thrown against the outside coils can make a pinging noise. This helps cool the condenser. You can reduce this noise by removing the subbase water plug.

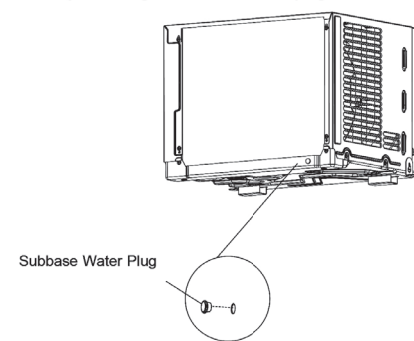

To ensure maximum efficiency it is recommended to check to ensure the rubber drain plug is properly inserted. This plug may be removed during operation to minimize water in the back of the unit; however, removing it will lower the efficiency of your unit.

NOTE: Do not drill hole in the base pan.