

# NINJA

DUALBREW / XL

## GROUNDS & PODS

HOT & ICED COFFEE MAKER

### TECHNICAL SPECIFICATIONS

Voltage: 120V-, 60Hz

Power: 1550W

Water Reservoir

Capacity: 70 oz.

# IMPORTANT SAFETY INSTRUCTIONS

PLEASE READ CAREFULLY BEFORE USE • FOR HOUSEHOLD USE ONLY



Read all instructions before using your Ninja DualBrew XL Hot & Iced Coffee Maker



Indicates the presence of a hazard that can cause personal injury, death or substantial property damage if the warning included with this symbol is ignored.



Avoid contact with hot surface. Always use hand protection to avoid burns.



For indoor and household use only.

## ⚠ WARNING

To reduce the risk of injury, fire, electrical shock or property damage, basic safety precautions must always be followed, including the following numbered warnings and subsequent instructions. Do not use appliance for other than intended use.

### General Precautions

- 1 To eliminate a choking hazard for young children, discard all packaging materials immediately upon unpacking.
- 2 This appliance can be used by persons with reduced physical, sensory or mental capabilities or lack of experience and knowledge if they have been given supervision or instruction concerning use of the appliance in a safe way and understand the hazards involved.
- 3 To reduce the risk of electric shock, this appliance has a polarized plug (one blade is wider than the other). As a safety feature, this plug will fit into a polarized outlet only one way. If the plug does not fit fully into the outlet, reverse the plug. If it still does not fit, contact a qualified electrician. **DO NOT** force into outlet or try to modify to fit.
- 4 Keep the appliance and its cord out of reach of children. **DO NOT** allow the appliance to be played with or be used by children. Close supervision is necessary when used near children.
- 5 To protect against fire, electric shock, and injury to persons, **DO NOT** immerse cord, plugs, or body of machine in water or other liquid.
- 6 **NEVER** carry the appliance by the power cord or pull it to disconnect from electrical socket; instead grasp the plug and pull to disconnect.
- 7 **DO NOT** operate any appliance with a damaged cord or plug, or after the appliance malfunctions, or has been dropped or damaged in any manner. Contact a service center.
- 8 For household and countertop use only. **DO NOT** let the power cord hang over the edge or touch hot surfaces such as the stove.
- 9 **NEVER** use socket below counter.
- 10 To avoid risk of fire, electrical shock, or damage to the brewer, **DO NOT** use brewer in an appliance garage or under a wall cabinet.
- 11 Unplug from outlet when either the appliance or display clock is not in use, and before cleaning.
- 12 Turn off and allow to cool before putting on or taking off parts, and before cleaning the appliance.

# READ AND SAVE THESE INSTRUCTIONS

814100155

# IMPORTANT SAFETY INSTRUCTIONS

PLEASE READ CAREFULLY BEFORE USE • FOR HOUSEHOLD USE ONLY

## ⚠ WARNING

To reduce the risk of injury, fire, electrical shock or property damage, basic safety precautions must always be followed, including the following numbered warnings and subsequent instructions. Do not use appliance for other than intended use.

### Operating Notice

- 1 To disconnect, turn any control to Off then remove plug from wall outlet.
- 2 The use of an accessory not recommended by the manufacturer may create an overflow condition and scalding hazard, or result in fire, electric shock, or personal injury.
- 3 **ALWAYS** use appliance on a clean, dry, level surface.
- 4 **DO NOT** place on or near a hot gas or electric burner or in a heated oven.
- 5 **DO NOT** use this appliance for anything other than its intended use.
- 6 **DO NOT** use outdoors.
- 7 **DO NOT** touch hot surfaces. Use handles or knobs.
- 8 **ALWAYS** place a vessel, carafe or cup beneath the brew basket to receive the brewed coffee.
- 9 **DO NOT** open brew chambers during brew cycle and cleaning cycle. Scalding may occur.
- 10 **DO NOT** remove the vessel, carafe or cup while the appliance is running without the Drip Stop in the closed position. Return the vessel, carafe or cup quickly and open the Drip Stop to continue the brew.
- 11 **DO NOT** fill water reservoir with anything other than water, as other liquids may damage your brewer.
- 12 **DO NOT** overfill the water reservoir. Fill water only to the Full line.
- 13 Keep lid on water reservoir when brewing.
- 14 **DO NOT** run the appliance without water.
- 15 **DO NOT** brew ground coffee without a #4 paper cone filter or permanent filter.
- 16 Exceeding maximum Coffee Measurement Chart capacity may cause overflow. **DO NOT** use fine or espresso ground coffee.

### Ninja® Pod Adapter

- 1 **DO NOT** put fingers inside Ninja Pod Adapter. There is one needle that punctures the pod top and one needle that punctures the pod bottom.
- 2 Only use capsules/pods intended for this appliance. If the capsule/pod does not fit, **DO NOT** force it into the appliance.

### Carafe

- 1 The carafe is designed for use with this appliance only. **DO NOT** place carafe on or near a hot gas or electrical burner, or in a heated oven.
- 2 **DO NOT** use a cracked or scratched carafe or a carafe that has a loose or weakened handle.
- 3 **DO NOT** place carafe in microwave.
- 4 **DO NOT** drink directly from the carafe. Liquid from the carafe may be very hot.
- 5 **DO NOT** use the carafe to store food when not in use.
- 6 Ensure the carafe is completely empty before starting a cleaning or brewing cycle. Starting a cycle with water, coffee, or tea in the carafe will cause an overflow.
- 7 **DO NOT** clean carafe with abrasive cleaners, steel wool pads, or other abrasive materials.
- 8 **DO NOT** set a hot carafe on a wet or cold surface.
- 9 **DO NOT** expose carafe to extreme temperature changes.

### Care & Maintenance

- 1 Allow the appliance to cool before removing any parts and before cleaning.
- 2 To prevent illness from bacterial growth in the appliance, follow all cleaning instructions in the Care & Maintenance section of this Owner's Guide.
- 3 Clean the system on a weekly basis.
- 4 If the product is not operating properly, visit [ninjakitchen.com](http://ninjakitchen.com) or contact SharkNinja Operating LLC for examination, repair, or adjustment.
- 5 Cleaning and user maintenance shall not be made by children.

### Cord Statement

- 1 A short power-supply cord is provided to reduce the risks resulting from becoming entangled in or tripping over a longer cord.
- 2 **DO NOT** use extension cords with this product.

## READ AND SAVE THESE INSTRUCTIONS

### PARTS

Note: Accessory type and quantity may vary depending on the model.

A Coffee Maker (Power cord not shown)

B 70 oz. Removable Water Reservoir

C Removable Water Reservoir Lid

D Drip Stop

E Ninja Grounds Adapter

F Single-Serve Cup Platform

G Control Panel

H Brew Basket

I Ninja Pod Adapter

J Brew-Through Lid

K Ninja Glass Carafe

L Ninja Smart Scoop™

M Intelligent Warming Plate

N Permanent Filter

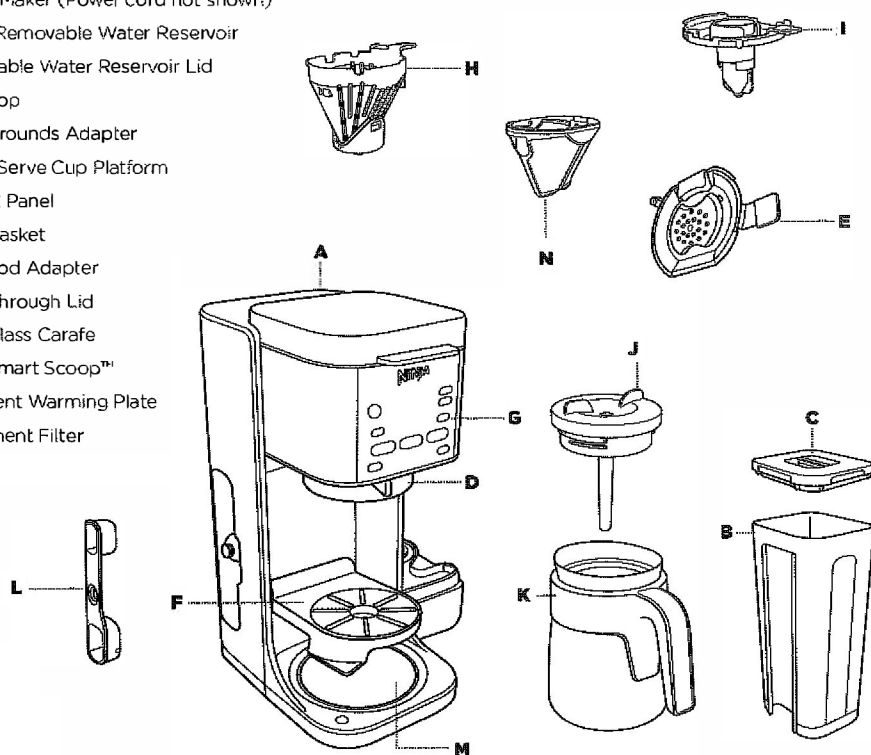

# USING THE CONTROL PANEL

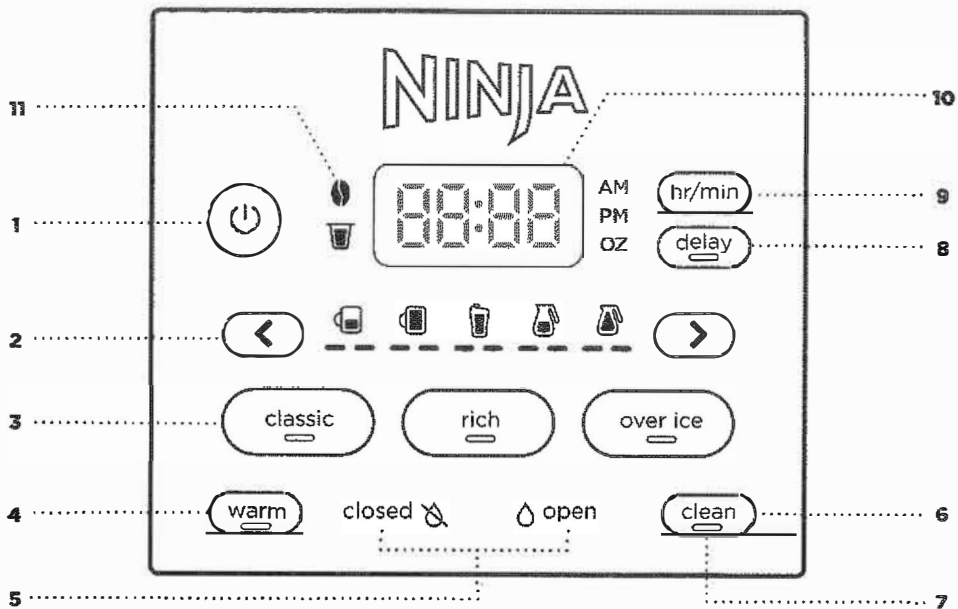

- 1 Power Button
- 2 Multi-Serve Arrow Buttons
- 3 Brew Styles
- 4 Keep Warm Button
- 5 Drip Stop indicators
- 6 Intelligent Clean Cycle Button
- 7 Intelligent Clean Cycle Indicator
- 8 Delay Brew Button
- 9 Hour/Minute Button
- 10 Programmable Digital Clock and Ounce Display
- 11 Smart Sensing Mode Indicators

The image shown here is for illustrative purposes only and may be subject to change. The actual descriptions of control panel and their locations may vary, depending on the model.

## SMART SENSING MODE INDICATORS

MODE INDICATORS	STATE
	<b>Grounds:</b> The Ninja Grounds Adapter is attached and the coffee maker lid is shut; ensure #4 paper filter or Permanent Filter is installed in the brew basket.
	<b>Pods:</b> The Ninja® Pod Adapter is inserted and the coffee maker lid is shut.
	<b>No State:</b> One of the above criteria has not been met.

# SETTING THE CLOCK

- 1 Press the HR/MIN button to set the clock.
- 2 Use the Multi-Serve Arrow Buttons to select the correct hour. Then, press the Hour/Minute button to toggle to minutes.
- 3 Use the arrow buttons again to select the correct minute, and press the Hour/Minute button to set the clock at the displayed time.

**NOTE:** If you unplug the brewer or in the event of a power loss, you will need to reset the clock the next time the brewer is plugged in.

## HIGH-ALTITUDE CALIBRATION BREW

Required for users in high-altitude areas. Not running the high-altitude calibration brew in a high-altitude area will result in excessive steaming during brewing.

Because water boils at a lower temperature at higher altitudes, running a calibration cycle before your first brew allows the brewer to detect the boiling point of water at your location. Running a calibration cycle will help deliver a consistent brew each time.

- 1 Fill the water reservoir up to, but not exceeding, the Full line.
- 2 Insert the Ninja Grounds Adapter and close the brewer lid, then place the empty carafe on the base.
- 3 Press and hold both CLASSIC and HR/MN until you hear a confirmation sound.
- 4 A calibration cycle will begin, and the display will count down until the Altitude calibration is complete. When complete, the brewer will beep and display "End" on the clock and ounce display. Discard the water in the carafe.

**NOTE:** This calibration is permanently saved and will not be lost if power is lost or brewer is unplugged. Brewer can be recalibrated at any time if the altitude where it is being used changes.

## USING THE NINJA POD AND GROUNDS ADAPTER

The Ninja DualBrew XL Coffee Maker comes with a unique Ninja Grounds Adapter already installed and an additional Ninja Pod Adapter for pods.

### INSTALLING THE NINJA POD ADAPTER

First, ensure the Ninja Grounds Adapter is removed from the coffee maker. Place the Ninja Pod Adapter in the brew basket, ensure the handle is aligned with the brew basket handle, and press down on the Ninja Pod Adapter firmly.

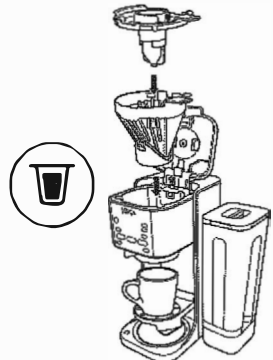

### INSTALLING THE NINJA GROUNDS ADAPTER

Place the Permanent Filter or #4 paper cone filter in the brew basket, add grounds, then place the Ninja Grounds Adapter over the brew basket and filter and ensure the handle is aligned with the brew basket handle.

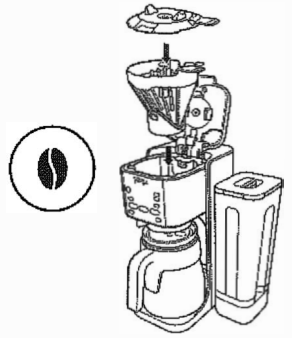

# PRIMING YOUR NINJA® DUALBREW XL HOT & ICED COFFEE MAKER

- 1 Clean all accessories before the first brew.
- 2 Plug the brewer in and turn it on by pressing the power button.
- 3 Lift the water reservoir off of its base. Remove the reservoir lid. Add water up to, but not exceeding the FULL line. Return the water reservoir to the brewer. **DO NOT** fill the water reservoir with anything other than water, as other liquids may damage your brewer.

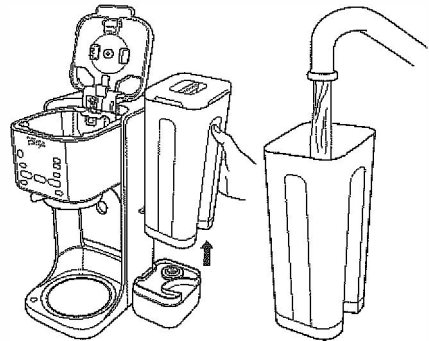

**NOTE:** We recommend using cool or room temperature water in the reservoir. **DO NOT** fill with hot or boiling water.

- 4 Ensure the Ninja Grounds Adapter is placed over the brew basket and is aligned with the brew basket handle and close the lid.

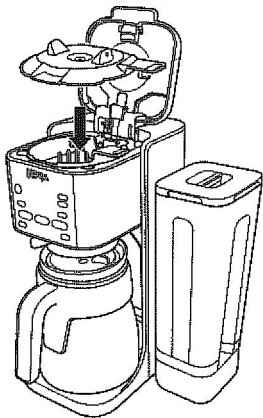

**NOTE:** **DO NOT** use coffee for the priming brew.

- 5 Center the carafe with the brew-through lid installed below the brew basket. With everything securely in place and the coffee maker powered on, use the Multi-Serve Arrow Buttons to select the Full Carafe size. Ensure the Drip Stop Indicator is set to Open.

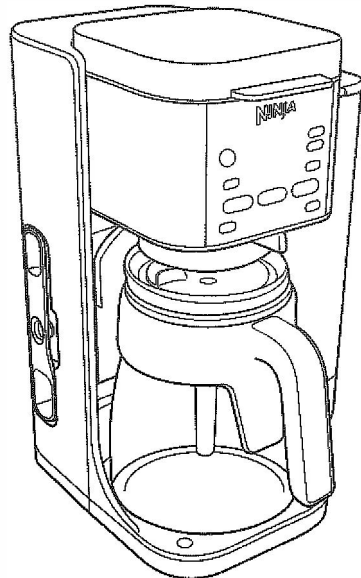

- 6 To start, press the CLASSIC brew style button. When the cycle is complete, discard the water and rinse the carafe. You are now ready to use your Ninja DualBrew XL Hot & Iced Coffee Maker.

# USING THE NINJA® DUALBREW XL HOT & ICED COFFEE MAKER

## BREW VOLUMES AND MEASUREMENTS

Each size and brew style produces a different amount of coffee to optimize strength and flavor. Rich brew will produce slightly less than Classic.

**NOTE:** The coffee grounds will absorb some of the water that is brewed; this will cause slight variability in brew volumes.

**NOTE:** Brew volumes may be slightly larger or smaller than what is stated due to various factors in the system.

**NOTE:** Over Ice is designed to brew coffee directly over ice, accounting for ice melt by delivering a reduced amount of coffee. The total volume listed in the Approximate Brew Volumes table reflects the overall drink volume, taking into account the ice in your cup.

## APPROXIMATE BREW VOLUMES

GROUNDS			
Size	Classic	Rich	Over Ice (filled with ice)
XS Cup	6 oz.	5 oz.	6 oz.
Sm Cup	8 oz.	7 oz.	8 oz.
Cup	10 oz.	8oz.	10 oz.
XL Cup	12 oz.	10 oz.	12 oz.
Travel	14 oz.	12 oz.	14 oz.
XL Travel	18 oz.	16 oz.	18 oz.
1/4 Carafe	28 oz.	26 oz.	28 oz.
1/2 Carafe	40 oz.	37 oz.	40 oz.
3/4 Carafe	52 oz.	47 oz.	52 oz.
Full Carafe	65 oz.	57 oz.	65 oz.

**NOTE:** There may be some water left in the reservoir after your brew. This is normal to keep the brewer from running out of water.

PODS			
Size	Classic	Rich	Over Ice (filled with ice)
6 oz.	6 oz.	6 oz.	6 oz.
8 oz.	8 oz.	8 oz.	8 oz.
10 oz.	10 oz.	9 oz.	10 oz.
12 oz.	12 oz.	11 oz.	12 oz.



# USING THE NINJA® DUALBREW XL HOT & ICED COFFEE MAKER CONT











## MEASURING YOUR COFFEE GROUNDS

For best results, use the measurements on the Ninja Smart Scoop™ or in the chart to determine how much ground coffee to use for each brew size. **Always use level scoops when measuring ground coffee.** The amount of ground coffee for each size will remain the same for any brew type you select. For example, if you select **10 oz.** and **Classic**, you will use the same amount of coffee grounds as if you were to select **10 oz.** and **Over Ice.**

**NOTE:** Adjust to your preferred taste. More scoops result in stronger coffee but slightly lower volumes, fewer scoops result in weaker coffee and slightly higher volumes.

**NOTE:** Use fewer scoops of decaffeinated coffee to prevent overflow. Use a medium-sized grind if grinding whole beans. Grinding beans too finely may cause the brew basket to overflow.

## COFFEE MEASUREMENT CHART

Serving Size	Ninja Smart Scoop	Tablespoons
XS Cup 	2-3 small scoops	2-3 tablespoons
Sm Cup 		
Cup 		
XL Cup 		
Travel 	3-5 small scoops	3-5 tablespoons
XL Travel 		
1/4 Carafe 	3-5 big scoops	6-10 tablespoons
1/2 Carafe 		
3/4 Carafe 	4-7 big scoops	8-14 tablespoons
Full Carafe 		

## BREWING GROUND COFFEE

### USING THE BREW BASKET

1 To prepare for brewing, open the coffee maker lid and ensure the brew basket is installed.

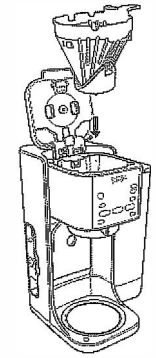

2 Place a #4 paper cone filter or Permanent Filter in the brew basket.

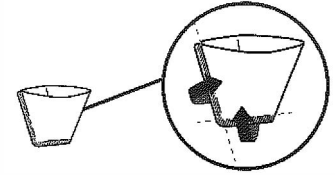
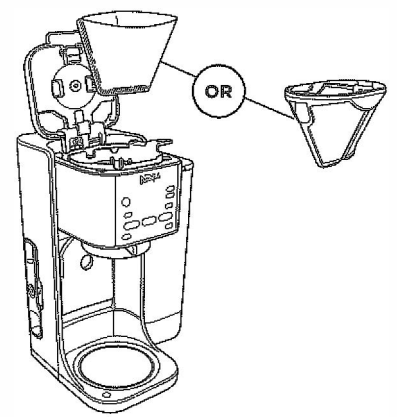

**NOTE:** Fold the paper filter along the seams, open the top fully, and firmly press it into the brew basket, making sure it is fully installed.

**NOTE: DO NOT** place ground coffee directly in the brew basket without a filter.

3 Use the Ninja Smart Scoop™ and follow the measurements on the scoop or on the Coffee Measurement Chart to fill the filter.

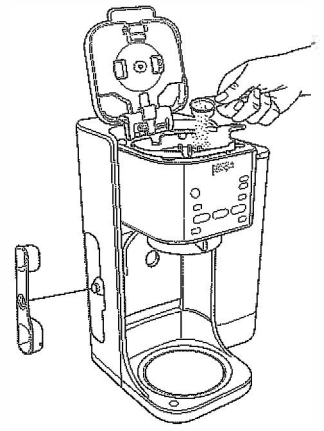

4 Place the Ninja Grounds Adapter over the brew basket so it is fully seated and is aligned with the brew basket handle.

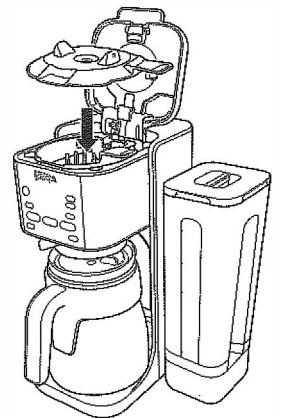

5 Close the coffee maker lid.

# USING THE NINJA® DUALBREW XL HOT & ICED COFFEE MAKER CONT.

## BREWING PODS

### USING THE NINJA POD ADAPTER

- 1 To prepare for brewing, open the lid, and ensure the brew basket is installed.

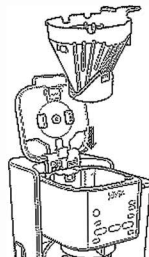

- 2 Place the Ninja Pod Adapter over the brew basket and ensure it is aligned with the brew basket handle.

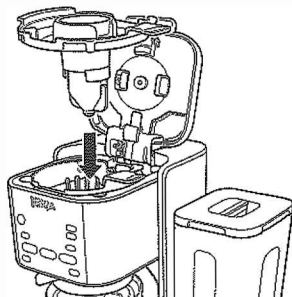

**NOTE:** Make sure the brew basket is clean and free of any filters before inserting the Ninja® Pod Adapter.

- 3 Place a new pod in the holder.

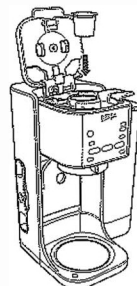

**IMPORTANT:** Ensure the pod is not damaged, torn, or expired. **DO NOT** remove the top of the pod.

**HIGH-ALTITUDE BREWING:** Before closing the Ninja Pod Adapter handle to start a brew, using your fingers, carefully apply pressure on the pod until the bottom of the pod is punctured by the exit needle, and the pod is fully seated in the pod holder. This releases excessive gas built up from the high altitude and prevents pod blowout.

- 4 Press the coffee maker lid down firmly to pierce the pod, and ensure that it is completely closed. There will be an audible click and some resistance when closing the handle as the needles puncture the pod.

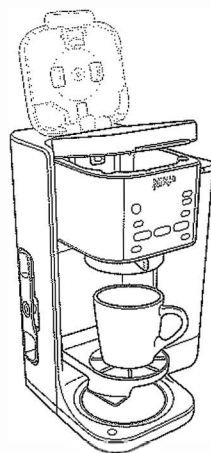

**NOTE:** Reusable K-Cup Coffee Filters are not compatible with the Ninja Pod Adapter. If using ground coffee, use the Ninja Grounds Adapter with a paper filter or included Permanent Filter to brew a single-serve size.

**NOTE:** Ninja Pods not included

The images shown here are for illustrative purposes only and may be subject to change.

## BREWING STYLES



CLASSIC

Smooth, well-balanced flavor.



RICH

More intense flavor that stands up to milk, cream, or flavoring.



OVER ICE

Specially designed to brew hot over ice for freshly brewed iced coffee that is not watered down.  
**Always fill your vessel to the top with ice cubes before brewing Over ice.**

**NOTE:** Over Ice brew is designed to produce a concentrated brew into a vessel filled with ice. It is normal for some ice in the vessel to melt as the coffee is brewed, and this will produce a cold beverage with the ideal strength and flavor.

**NOTE:** Rich brew will use slightly less water and yield slightly less brewed coffee than Classic brew. See Approximate Brew Volumes chart for additional information.

## HOW TO BREW

- 1 Use the Multi-Serve arrow buttons to select the brew size. Place the empty vessel or carafe under the brew basket.

**NOTE:** If making a single cup, lower the Single-Serve Cup Platform and set your vessel in the center of it to help prevent splashing. This applies to all brew styles.

- 2 Press either the CLASSIC, RICH, or OVER ICE brew style to start your brew. To cancel the brew at any time, press the selected brew style again or press the Power button.

**NOTE:** The brewing cycle will begin, then pause for a short period before resuming. This process is used to evenly saturate the coffee grounds. This applies to all brew styles.

- 3 The brewer will beep to signal the brew has started. The progress bar between the arrows will illuminate to indicate the progress of the brew. When the brew is finished, the machine will beep again and End will appear on the display.

# USING THE NINJA® DUALBREW XL HOT & ICED COFFEE MAKER CONT.

## INTELLIGENT WARMING PLATE

The Intelligent Warming Plate will automatically turn on during Classic or Rich brews when a 1/4, 1/2, 3/4, or full carafe size is selected. The Intelligent Warming Plate is set to a specific temperature to avoid burning the coffee over time. To turn the warming plate on at any time, use the Multi-Serve Arrow buttons to select one of the carafe sizes and press the WARM button.

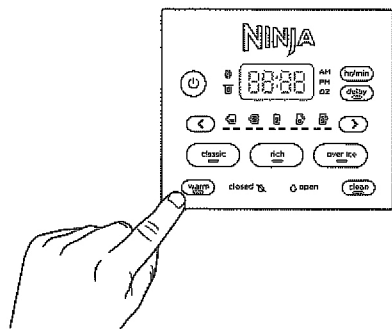

**IMPORTANT:** The  light on the base of the brewer will illuminate only when the warming plate is hot and will remain illuminated until the plate has cooled down.

## TIME & TEMPERATURE ADJUSTMENT

You can adjust how long the Intelligent Warming Plate remains on (up to 4 hours) and/or set the temperature to High, Medium, or Low.

By default, the Intelligent Warming Plate is set to remain on for 2 hours at Medium temperature. To change the time and/or temperature setting of your warming plate, follow these instructions:

- 1 Press and hold WARM until the clock begins to flash the current warming time.
- 2 Use the Multi-Serve Arrow buttons to increase the time in 15 minute increments up to 4 hours or decrease the time to 0 hours. Press WARM button to set the new time.
- 3 Next, the clock will display the current warming plate temperature. To keep the same temperature, press WARM. To change the temperature, use the Multi-Serve Arrow Buttons and press WARM for the temperature to lock in. The unit will beep signifying that the time and temperature has been set.

**NOTE:** If you set the warming time to 0 hours, Keep Warm will not automatically activate during or after a carafe brew cycle, but you can still turn it on manually by pressing the WARM button when a carafe size is selected.

**NOTE:** The time adjustment setting will be saved and will not reset when the brewer is unplugged or loses power.

## SETTING THE DELAY BREW

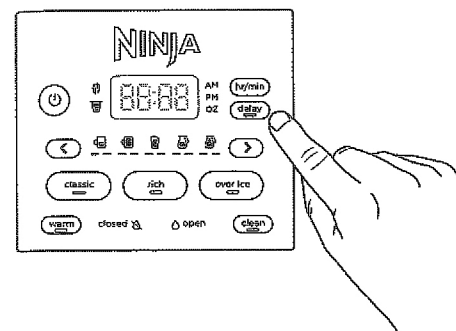

- 1 Fill the water reservoir to desired size and add ground coffee to the filter or insert a pod in the Ninja Pod Adapter, close the coffee maker lid, and place the appropriate-size vessel under the brew basket.
- 2 Press DELAY. DELAY will illuminate and the clock will begin to flash "12:00" or the last time that was set.
- 3 While the clock is flashing, use the Multi-Serve Arrow buttons to adjust the hour. The AM or PM indicator will illuminate on the clock display as you are setting the desired time. Press DELAY button again and use the Multi-Serve Arrow buttons to adjust the minute. Press DELAY to lock in the time.

- 4 Once the desired time has been set, use the Multi-Serve Arrow Buttons to select the size that you would like to brew.
- 5 Select either CLASSIC, RICH, or OVER ICE to choose your brew style.
- 6 Once the time, brew size, and brew style have been set, press the DELAY button to activate. When activated, the brewer will beep and the DELAY LED and your selected options will remain illuminated. To view your set delay brew time, press and hold the DELAY button. To cancel, press DELAY again or power off the coffee maker.

**NOTE:** The brewer must remain on for the Delay Brew function to work. **DO NOT** power off or unplug after setting Delay Brew. If the brewer is turned off or unplugged, delay brew will need to be reset.

**NOTE:** The clock will remain on even if the brewer is turned off. Ensure the brewer is powered on to set Delay Brew.

The image shown here is for illustrative purposes only and may be subject to change. The actual descriptions of control panel and their locations may vary, depending on the model.

# USING THE NINJA® DUALBREW XL HOT & ICED COFFEE MAKER CONT.

## USING THE DRIP STOP

The drip stop is used to close off the brew basket to prevent any coffee from dispensing. You will need to manually open and close the drip stop by moving the lever to your desired position. It can be closed and reopened at any point before, during, or after a brew.

If you forget to open the Drip Stop, the brewer will pause the brew, and after 30 seconds it will give you a friendly audible reminder. After 5 minutes, the brew will be canceled.

**NOTE:** If the Drip Stop is closed before you begin a brew, the brewer will notify you with 3 beeps and the Drip Stop indicator will illuminate. Move the Drip Stop to the open position and press the CLASSIC, RICH, or OVERICE buttons to begin your brew.

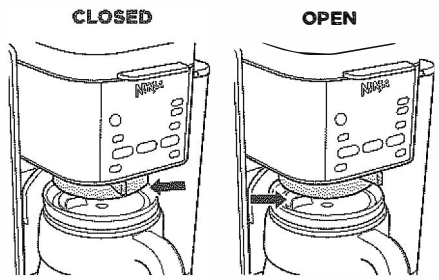

## CLOSING THE DRIP STOP AFTER A BREW

When the brew cycle is complete, set the Drip Stop to the closed position to stop dripping from the brew basket. While the Drip Stop is closed, the Drip Stop indicator will illuminate.

**NOTE:** Remember to open the Drip Stop when you are ready to brew again. If you forget, your brewer will give you a friendly audible reminder.

# CLEANING & MAINTENANCE

## CLEANING AFTER A BREW

- 1 After the coffee maker has cooled, remove the Ninja Grounds Adapter and brew basket. If using pods, remove the Ninja Pod Adapter and brew basket. Wash the used parts thoroughly with soap and warm water.
- 2 Wash the carafe and brew-through lid with soap and warm water. Use a bottle brush or cloth to wash the inside of the carafe. **DO NOT** use a wire brush.

**NOTE:** For best results, we recommend rinsing the reservoir after brewing and refilling with fresh water for the next brew.

## CLEANING THE WATER RESERVOIR

Empty the reservoir and hand-wash or place in dishwasher. For a better clean, we recommend placing it in the bottom rack of the dishwasher standing upright with the opening facing downward. We recommend doing this weekly.

## CLEANING THE CARAFE

We recommend cleaning your carafe after each use with warm, soapy water.

To clean the carafe more thoroughly, we recommend using a soft foam brush.

**DO NOT** use a wire brush to clean carafe.

## CLEANING THE BREW BASKET, NINJA POD AND GROUNDS ADAPTER

If brewing grounds, allow the coffee maker to cool. First remove the Ninja Grounds Adapter by pinching the right tab of the handle and either lift straight up if on top of the brew basket, or pull out of the coffee maker lid. If brewing pods, first remove and discard the used pod, then remove the Ninja Pod Adapter by pinching the right tab of the handle and lifting straight up. Wash the Ninja Pod Adapter, Ninja Grounds Adapter, and Brew Basket with warm soapy water.

# CLEANING & MAINTENANCE CONT.

## CLEANING & DESCALING YOUR BREW SYSTEM

The clean cycle is used for descaling the brewer when calcium scale buildup is affecting the performance of the brewer and/or the flavor of your coffee. The Intelligent Clean Cycle Indicator will automatically illuminate orange when a cleaning cycle is recommended for your brewer.

To clean and descale your Ninja DualBrew Coffee Maker:

- 1 Place the empty carafe beneath the brew basket.
- 2 Fill the water reservoir with 16 oz. of white vinegar, then fill the rest of the reservoir with water up to, but not exceeding, the Full line.

### OR

Use a descaling solution specifically formulated for coffee maker cleaning and follow the directions on the package.

**NOTE:** The clean cycle takes approximately 90 minutes.

**IMPORTANT:** Only use white vinegar.

**NOTE:** If the display ever reads "CLOG," it indicates heavy or residual coffee ground buildup. Refer to the "CLOG" section in the troubleshooting guide.

**NOTE:** Running a water-only clean cycle will not descale the brewer properly.

- 3 Once the water reservoir is filled with your cleaning solution and water mixture, press the CLEAN button. The display will highlight the full carafe and 70 oz. which is the amount that will be brewed. Then press the CLEAN button again to confirm and begin the cleaning cycle.

**NOTE:** To cancel the clean cycle, press the Power button or CLEAN button once. The brewer will beep and stop brewing through the cleaning mixture. Continue to follow the instructions starting at Step 6.

**IMPORTANT:** If you cancel the clean cycle, your brewer will not be properly descaled.

- 4 The clock will display and count down the remaining clean cycle time, which takes approximately 90 minutes to complete. Your brewer will deliver a small amount of cleaning solution to distribute through the system. It will then pause, deliver additional cleaning solution, and repeat this process for 90 minutes. The extended pauses allow for maximum cleaning and descaling.

**IMPORTANT: DO NOT** remove the carafe at any time during the clean cycle.

- 5 Upon completion, the brewer will beep, the clock will display End, and the Intelligent Clean Cycle Indicator will turn off.
- 6 Empty the contents of the carafe and place it back under the brew basket. Clean the water reservoir with warm, soapy water to remove any cleaning solution that could affect the flavor of your coffee.
- 7 Fill the reservoir with fresh water up to, but not exceeding, the Full line.
- 8 Flush the system by running a full carafe classic water-only brew. After the cycle is complete, discard the water and thoroughly clean the carafe and brew basket.

**NOTE:** Hard water will cause scale buildup faster than soft water and the brewer will indicate it needs cleaning more often.

# TROUBLESHOOTING GUIDE

## CLOCK DISPLAY MESSAGES:

### CLOG

- If this appears on your control panel, this means either there are grounds built up inside the top or bottom needles or calcium scale buildup in the brew system.
  - 1 Ensure that the top and bottom of the pod you are using is punctured.
    - a. If the pod wasn't punctured, try another pod, pressing down firmly on the top of the pod to ensure it is pierced by the bottom needle, then close the coffee maker lid.
    - b. If the new pod still did not puncture, please contact a service center.
    - c. If the pod was punctured, go to step 2.
  - 2 Check if there are any visible grounds inside the top and bottom needles:
    - a. If there are grounds in the top and bottom needles, use a flat wire or plastic clip such as a paper clip to clean the grounds out of the needles.
    - b. After cleaning out the needles, restart the system by turning off the coffee maker, then turning it back on, and run a water-only full carafe classic brew to clear the system.
    - c. If there are no grounds present or the display still shows "CLOG", go to Step 3.
  - 3 There may be calcium scale buildup in the brew system and a clean cycle needs to be run immediately to remove the buildup. See 'Cleaning & Descaling Your Brew System' for instructions.

### End

- The brew cycle is complete.

### Add Wtr

- The system does not have enough water in the reservoir to complete your brew. Add fresh water to the reservoir and then press the brew style button that was being brewed to resume the brew.
- If the reservoir is filled with water, remove and reseat the reservoir by pressing firmly down on the reservoir. If the issue persists, contact a service center.

### STOP

- A brew cycle was cancelled.

## ERROR MESSAGES:

### Er

- If the clock displays "Er" and then a number (ex. "Er 03"), contact a service center.

### There's sediment in my coffee.

- If using the Permanent Filter, this may be due to using finely ground coffee.
- To reduce the amount of sediment in the brewed coffee, use a slightly coarser grind or use a paper filter.

**NOTE: DO NOT** use a paper filter in conjunction with a Permanent Filter, as water and/or coffee can back up and clog the filter basket.

### Over Ice Brew is not cold.

- Ensure your cup, travel mug, or carafe is filled all the way to the top with ice cubes before brewing. Brewer will brew at elevated temperatures to lock in the best flavor, then the ice will cool the brewed coffee to the perfect temperature.

### Coffee is too weak.

- For stronger coffee, use the Rich brew setting. For an even bolder flavor, you can add more coffee grounds to the filter.

### Coffee is too strong.

- For milder coffee, use the Classic brew setting. For an even milder flavor, use fewer coffee grounds in the filter.

### Brew cycle is too slow.

- The brew time will vary based on size and brew style. Full carafe sizes and Rich brews will take longer to brew than single-serve and classic brews. The progress bar on the control panel will indicate brew progress.

### Cup or travel mug overflowed.

- Refer to the Approximate Brew Volumes chart.

# TROUBLESHOOTING GUIDE CONT.

## **Brew basket overflowed.**

- The bottom of the brew basket may be clogged. This can happen with finely ground coffee or too many coffee grounds in the filter. Medium-grind coffee is recommended.
- Using a Permanent Filter in conjunction with a paper filter can cause grounds to clog and water to back up in the brew basket. Use only the Permanent Filter or a paper filter.
- Decaf coffee grounds absorb water differently, so use fewer scoops when using decaf.

## **There is water left in the reservoir.**

- When the reservoir is filled to a specific size and then that size is brewed, there will be some water left in the reservoir. This is normal to ensure the reservoir does not run dry for the best performance of the pump and brew system.

## **Brewer is leaking.**

- After removing the water reservoir, there may be a small amount of water in the reservoir valve. This can be easily removed with a dry cloth.
- If the leak is coming from above the brew basket, refer to "Brew basket overflowed." above.
- If the leaking is coming from below the brew basket, close the drip stop.
- If the leak is coming from the bottom of the brewer, contact a service center.

## **Intelligent Clean Cycle Indicator is illuminating orange.**

- Run a clean cycle. If you have recently completed a clean cycle, you may need to run another cycle to remove additional mineral buildup that occurs naturally over time and is common in hard-water areas. Make sure you are using vinegar or a descaling solution and follow the cleaning.

## **Brewer is not detecting the Ninja<sup>®</sup> Pod Adapter.**

- Ensure the adapter is fully seated in place over the brew basket with the coffee maker lid closed.

## **Coffee is splattering.**

- Some splatter is normal. Use the cup tray when possible to reduce the distance between the cup and the coffee outlet.
- Ensure the Ninja Pod adapter is installed over the brew basket when brewing pods.

## **Water reservoir is unstable.**

- Ensure the water reservoir is properly installed on the hook on the side of the brewer and pressed down firmly into the water reservoir base.



Please make sure to read the enclosed Ninja® Owner's Guide prior to using your unit.

# NINJA

## DUALBREW / XL

### GROUND & PODS

#### HOT & ICED COFFEE MAKER

# BEFORE YOUR FIRST BREW

**IMPORTANT:** Ensure you prime your coffee maker before your first brew.

#### TO PRIME YOUR COFFEE MAKER:

- 1 Plug it into an outlet and turn it on.
- 2 Fill the water reservoir to the FULL line with fresh water and place it on the base.
- 3 Place the empty carafe under the brew basket and run a water-only Full Carafe, Classic brew.
- 4 Once the brew is complete, discard the water; the coffee maker is now primed for use.

**NOTE:** If using the brewer in a high-altitude area, running a calibration brew is required. Not running a high-altitude calibration brew in a high-altitude area will result in excessive steaming during brewing. Refer to page 4 of the Owner's Guide for instructions on running a high-altitude calibration brew.

#### WHAT'S IN THE BOX

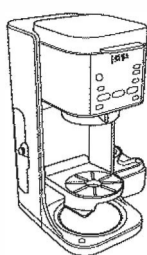

**NINJA DUALBREW XL HOT & ICED COFFEE MAKER**

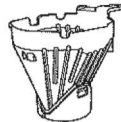

**BREW BASKET**  
Comes fully installed in the brewer. It must always be inserted when brewing pods or grounds.

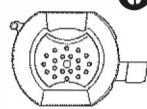

**NINJA GROUNDS ADAPTER**  
Comes fully installed in the brewer. Used only for brewing ground coffee. Always insert it over the brew basket when brewing grounds.



**PERMANENT FILTER**  
Used for brewing grounds. Ensure Grounds Adapter is installed and permanent filter is placed over brew basket.



**NINJA POD ADAPTER**  
Used only for brewing pods. Always insert it over the brew basket when brewing pods. **Do not insert over a permanent or paper filter. (Ninja Pods not included).**



**NINJA SMART SCOOP™**  
Use this to measure coffee grounds.



**14 CUP GLASS CARAFE**

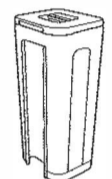

**70 OZ. REMOVABLE WATER RESERVOIR**  
Dispenses water based on selected brew size. No need to fill every time.

Note: Accessory type and quantity may vary depending on the model.

#### PREPARING YOUR BREW



**NINJA POD ADAPTER**  
For brewing pods. (Ninja Pod not included).

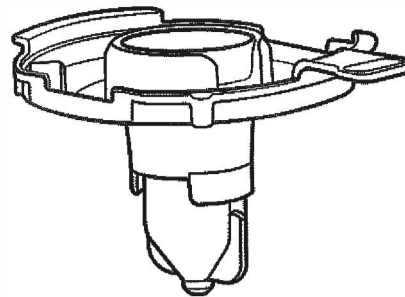

- 2 Place the Ninja Pod Adapter over the brew basket and ensure it is aligned with the brew basket handle.

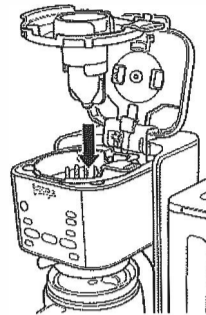

- 1 If the Ninja Grounds Adapter is installed, remove it from the lid and ensure there is no filter in the brew basket.

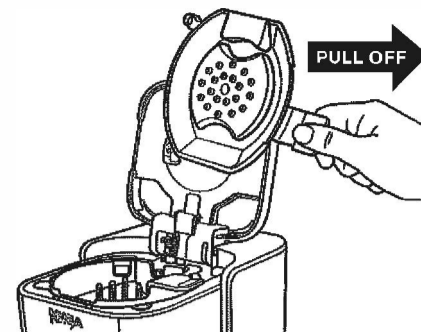

- 3 Place a pod in the Ninja Pod Adapter and close the coffee maker lid firmly to pierce the pod.

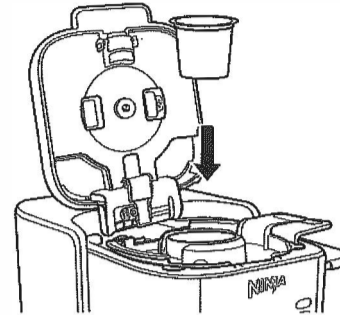

**NINJA GROUNDS ADAPTER**  
For brewing grounds.

Comes installed on the underside of the lid.

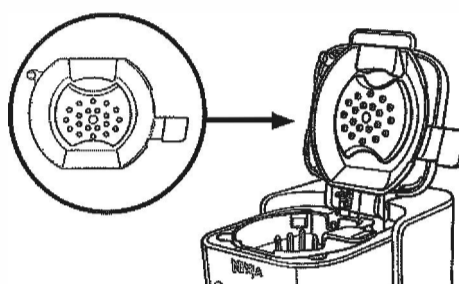

- 1 Place a #4 cone paper filter or permanent filter in the brew basket.

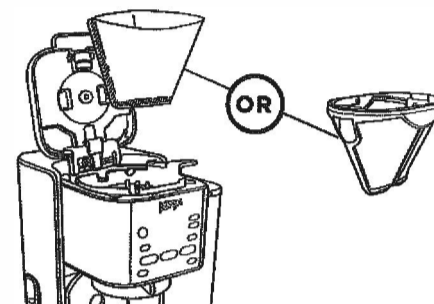

- 2 Use the Ninja Smart Scoop to fill the filter. More scoops result in stronger coffee but slightly lower volumes; fewer scoops result in weaker coffee but slightly higher volumes.

- 3 If not already installed, place the Ninja Grounds Adapter over the brew basket and ensure it is aligned with the brew basket handle. Close the coffee maker lid.

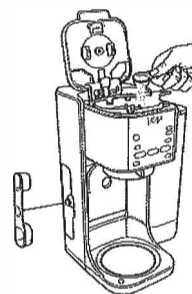

SERVING SIZE	NINJA SMART SCOOP
<b>GROUND COFFEE</b>	
	2-3 small scoops
	3-5 small scoops
	3-5 big scoops
	4-7 big scoops

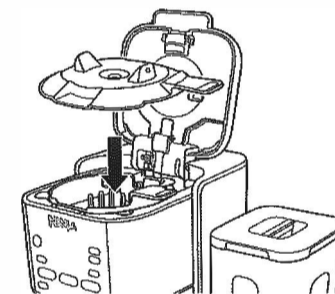

#### HOW TO BREW

##### 1 CHOOSE A METHOD



Use the Ninja Grounds Adapter and a filter

**GROUND**



Use the Ninja Pod Adapter

**PODS**

##### 2 CHOOSE A SIZE

Use the Multi-Serve arrow buttons to select the brew size. Place the empty vessel or carafe under the brew basket.

Ensure reservoir has enough water for your brew size. The reservoir dispenses water based on your selected brew size so there is no need to fill every time.

The image shown here is for illustrative purposes only and may be subject to change. The actual descriptions of control panel and their locations may vary, depending on the model.

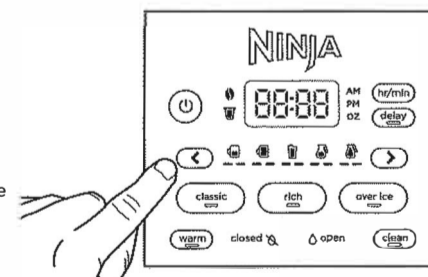

##### 3 SELECT A BREW STYLE TO START BREW

Press either the **CLASSIC**, **RICH**, or **OVER ICE** brew style to start your brew. There will be an illuminating progress bar on the display to track the progress of your brew.



**CLASSIC**  
Smooth, well balanced flavor.

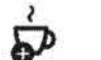

**RICH**  
More intense flavor. Brews slightly less coffee than Classic.



**OVER ICE**  
Always fill your vessel to the top with ice cubes prior to brewing. Coffee dispensed accounts for ice melt.



**THE BREW MAY PAUSE ONCE OR MULTIPLE TIMES DURING THE BREW CYCLE. THIS IS NORMAL.** Pausing allows the coffee grounds to fully extract and unlock the full flavor of the brew style.

#### DRIP STOP

The drip stop is used to close off the brew basket to prevent any coffee from dispensing. You will need to manually open and close the drip stop by moving the handle to your desired position. The drip stop can be closed and reopened at any point before, during, or after a brew.

**RIGHT POSITION OPEN**

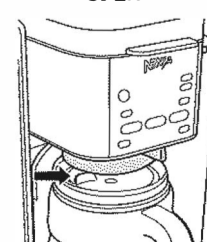

**LEFT POSITION CLOSED**

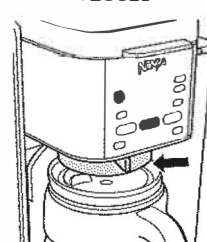

The images shown here are for illustrative purposes only and may be subject to change.

