

# Shark STRATOS

## DuoClean® PowerFins™ HairPro™

### Powered Lift-Away® with Self-Cleaning Brushroll and Odor Neutralizer Technology Upright Vacuum



#### OWNER'S GUIDE

## IMPORTANT SAFETY INSTRUCTIONS

FOR HOUSEHOLD USE ONLY

### ⚠ WARNING

To reduce the risk of fire, electric shock, injury, or property damage, when using an electrical appliance, basic precautions should always be followed, including the following:

#### READ ALL INSTRUCTIONS BEFORE USING THIS VACUUM

- Inspect power cord and plug for any damage before use. **DO NOT** use vacuum cleaner with a damaged cord or plug. Turn off all controls before plugging in or unplugging the vacuum cleaner. Store your vacuum cleaner with the power cord secured around the two cord hooks. To minimize the risk of power cord damage, do not allow the motorized brush roll to ingest the cord. If this occurs, immediately shut off power to the vacuum and remove the cord.
- This appliance has a polarized plug. If the plug does not fit fully into the outlet, reverse the plug (one blade is wider than the other). If it still does not fit, contact a qualified electrician. **DO NOT** force into outlet or try to modify to fit.
- Your vacuum cleaner may consist of a motorized nozzle, wand, hose, and/or vacuum pod. This device contains electrical connections, electrical wiring, and moving parts that potentially present risk to the user. The hose contains electrical wires. Do not use when damaged, cut, or punctured.
- Use only identical replacement parts.
- Carefully observe and follow the instructions provided below to avoid improper use of the appliance. **DO NOT** use the vacuum for any purpose other than those described in this manual.
- Before use, carefully inspect all parts for any damage. **DO NOT** use if any parts are damaged.
- The use of an extension cord is **NOT** recommended.
- This vacuum cleaner contains no serviceable parts.
- This appliance can be used by persons with reduced physical, sensory, or mental capabilities or lack of experience and knowledge if they have been given supervision or instruction concerning use of the appliance in a safe way and understand the hazards involved. Cleaning and user maintenance shall not be made by children. Keep the appliance and its cord out of reach of children. **DO NOT** allow the appliance to be used by children. **DO NOT** allow to be used as a toy. Close supervision is necessary when used near children.
- Always turn off the vacuum cleaner before connecting or disconnecting any motorized nozzles, hose, or other accessories.

- DO NOT** handle plug or vacuum cleaner with wet hands.
- DO NOT** use without filters in place.
- Only use Shark® branded filters and accessories.
- DO NOT** damage the power cord:
  - DO NOT** pull or carry vacuum cleaner by the cord or use the cord as a handle.
  - DO NOT** unplug by pulling on cord. Grasp the plug, not the cord.
  - DO NOT** run the vacuum cleaner over the power cord, close a door on the cord, pull the cord around sharp corners, or leave the cord near heated surfaces.
- DO NOT** put any objects into nozzle or accessory openings. **DO NOT** use with any opening blocked; keep free of dust, lint, hair, and anything that may reduce airflow.
- DO NOT** use if nozzle or accessory airflow is restricted. If the air paths or the motorized floor nozzle become blocked, turn the vacuum cleaner off and unplug from electrical outlet. Remove all obstructions before you plug in and turn on the unit again.
- Keep nozzle and all vacuum openings away from hair, face, fingers, uncovered feet, or loose clothing.
- DO NOT** use if vacuum cleaner is not working as it should, or has been dropped, damaged, left outdoors, or dropped into water.
- Use extra care when cleaning on stairs.
- DO NOT** leave the vacuum cleaner unattended while plugged in.
- When powered on, keep the vacuum cleaner moving over the carpet surface at all times to avoid damaging the carpet fibers.
- DO NOT** place vacuum cleaner on unstable surfaces such as chairs or tables.
- Your Shark® vacuum may not be designed to stand up on its own. When taking a break from cleaning, you may need to lean it against furniture or a wall, or lay it flat on the floor. Using the vacuum for an application where the unit lacks stability may result in personal injury.
- DO NOT** use to pick up:
  - Liquids
  - Large objects
  - Hard or sharp objects (glass, nails, screws, or coins)
  - Large quantities of dust (drywall dust, fireplace ash, or embers).**DO NOT** use as an attachment to power tools for dust collection.

- Smoking or burning objects (hot coals, cigarette butts, or matches)
  - Flammable or combustible materials (lighter fluid, gasoline, or kerosene)
  - Toxic materials (chlorine bleach, ammonia, or drain cleaner)
- DO NOT** use in the following areas:
    - Poorly lit areas
    - Wet or damp surfaces
    - Outdoor areas
    - Spaces that are enclosed and may contain explosive or toxic fumes or vapors (lighter fluid, gasoline, kerosene, paint, paint thinners, mothproofing substances, or flammable dust).
  - Turn off all controls before plugging in or unplugging the vacuum.
  - Observe the following when interacting with the odor neutralizer technology cartridge
    - DO NOT** attempt to disassemble odor neutralizer technology cartridge.
    - Avoid direct contact with the fragrance pod in the cartridge.
    - DO NOT** directly inhale from the odor neutralizer technology cartridge
    - Keep away from children and pets.
    - Keep away from heat, sparks, and open flame.
    - DO NOT** place in direct sunlight.

#### FRAGRANCE CARTRIDGE FIRST AID

- Avoid contact with fabrics and finished surfaces.
  - Eye contact: Remove contact lenses if present. Rinse continuously with water for several minutes.
  - Skin contact: Wash hands thoroughly after handling. If irritation or rash develops, seek medical advice/attention.
  - Inhalation: Move person to fresh air if they are experiencing any respiratory symptoms. If symptoms persist, seek medical advice/attention.
  - Ingestion: **DO NOT** induce vomiting. Seek medical advice/attention.
- Unplug from electrical outlet when not in use and before any maintenance or cleaning.
  - Hand wash with water only. Washing with cleaning chemicals could damage the unit.
  - During cleaning or routine maintenance, **DO NOT** cut anything other than hair, fibers, or string wrapped around the brushroll.
  - Allow all filters to air-dry completely before replacing in the vacuum to prevent liquid from being drawn into electric parts.
  - Make sure the dust cup and all filters are in place after routine maintenance.
  - If provided, secure the power cord around the two cord hooks during storage.

## SAVE THESE INSTRUCTIONS

#### ASSEMBLY

**NOTE:** Accessories may vary depending on the model. Refer to quick guide, if available.

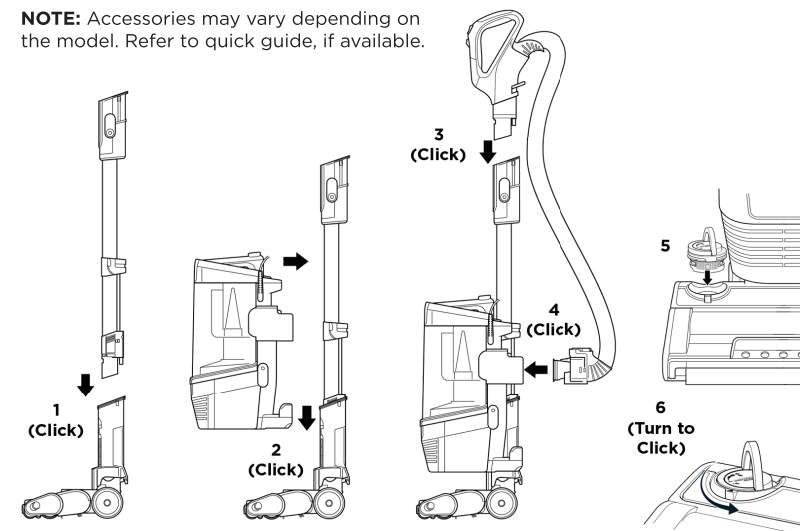

- Place motorized **Nozzle** on floor and insert **Wand**, pressing it in until it clicks securely into place.
- Place **Pod** onto wand and slide down to connect.
- Insert **Handle** into wand, pressing it in until it clicks securely into place.
- Connect **Hose** to back of pod, pressing it in until it clicks securely into place.
- Flip up the dial handle, align the teal arrows, then insert the **Odor Neutralizer Technology Dial** into the nozzle.
- To lock and engage the dial, rotate it counterclockwise until it clicks into the desired odor intensity setting.

\* More detailed odor neutralizer technology assembly instructions and visuals on the following pages.

**IMPORTANT:** For proper operation, ensure all connections are securely clicked into place.

**NOTE:** Odor cartridge sold separately



PRINTED IN MEXICO Elbrd: M.C  
OBPN: AZ3000\_SERIES\_IB\_E\_F\_S\_MP\_220316  
SC: 09-30-2022 / TAB SHNMDL: AZ3000\_B

#### TECHNOLOGY SETTINGS

##### SETTINGS

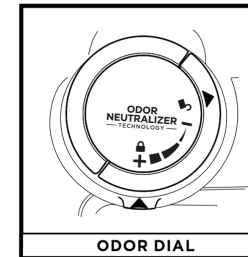

Flip up the dial handle and rotate the odor dial to adjust odor neutralizer technology intensity or to unlock the dial for cartridge access.

**Insertion/Removal:** Rotate the odor dial to align the teal arrows. Remove the dial to access the teal odor cartridge for removal or replacement.

**Low:** Rotate the dial toward the Low position to decrease the intensity to the lowest level when the vacuum is in use.

**High:** Rotate the dial toward the High position for the highest intensity level when the vacuum is in use. This position is the recommended setting for optimal performance.

#### ODOR NEUTRALIZER TECHNOLOGY TIPS

##### Odor Dial Must be Installed for Vacuum to Function Properly

• Remove odor cartridge from dial if you don't want the benefits of the odor neutralization technology. (**Odor cartridge not included, sold separately**)

##### Maintenance Required

- Clean all filters as recommended under Cleaning Filters.
- Empty the dust cup before storing your vacuum.
- Replace the cartridge as recommended under Odor Cartridge Replacement.
- Visit [qr.sharkclean.com/odortech](http://qr.sharkclean.com/odortech) to learn more and purchase replacements.
- If wet pet messes are cleaned up, thoroughly clean the vacuum.

##### Fragrance Strength Over Time

• The intensity of the odor neutralizer technology's fragrance may diminish over time. It may also have no noticeable fragrance at all. This is natural and does not indicate the technology isn't working. Follow replacement instructions to ensure continued performance.

**NOTES:** • The odor dial needs to be installed for the vacuum to function properly, with or without the odor cartridge.  
• Odor Neutralizer technology effectively deodorizes while interacting with odors from inanimate sources.

#### ODOR NEUTRALIZER TECHNOLOGY

#### ODOR CARTRIDGE REPLACEMENT

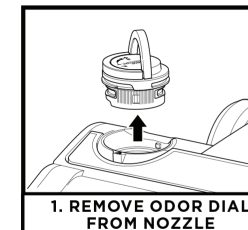

Flip up the handle and rotate the dial clockwise until the two teal arrows are aligned. Pull the handle to remove the dial from the nozzle.

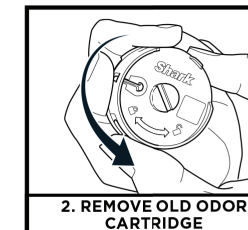

Rotate the cartridge counterclockwise in the dial housing and pull out the cartridge to remove it.

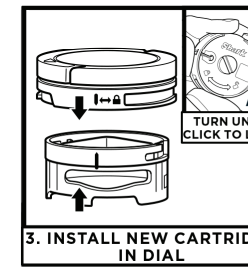

Align the yellow arrow on the side of the cartridge with the yellow arrow on the side of the dial cover, then insert the cartridge into the dial. Rotate the cartridge clockwise to lock it in place.

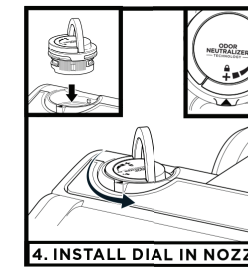

Align the teal arrow on the dial cover with the teal arrow on the nozzle, then reinsert the dial into the nozzle. Rotate the dial counterclockwise until it clicks into an intensity setting to engage. Rotate further to change the intensity setting.



Dispose of the old cartridge by dropping it into the trash.

**NOTE:** Odor cartridges should be replaced every 6 months for optimal odor neutralizer technology performance.

## WHOLE-HOME CLEANING

### SETTINGS

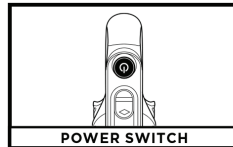

POWER SWITCH

Press power button to turn on vacuum. Please note the brushrolls will not spin unless the wand is reclined.

**NOTE:** Try using Hard Floor mode for low pile area rugs.

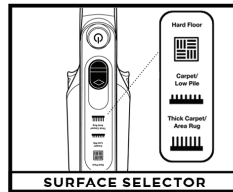

SURFACE SELECTOR

#### Thick Carpet & Area Rug Cleaning

Slide the surface switch to the top position to select Thick Carpet/Area Rug.

#### Carpet & Low Pile Cleaning

Slide the surface switch to the middle position to select Carpet/Low Pile to increase the speed of the brushrolls and to help remove stuck-on dust and debris.

#### Hard Floor Cleaning

Slide the surface switch to the bottom position to select Hard Floor.

### HEADLIGHT INDICATOR LIGHTS

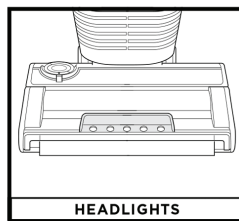

HEADLIGHTS

The headlights will flash or turn red to indicate issues that need attention.

**Solid White Lights:** The brushrolls are spinning and the unit is working as it should.

**Solid Red Lights:** There is a jam in the brushroll area. Turn off the vacuum and unplug it, then remove any blockages in the nozzle.

**Flashing Red Lights:** The motorized floor nozzle is overheating. Turn off the vacuum, unplug it, and remove any blockages. Let the vacuum cool down for at least 60 minutes before

restarting. See Troubleshooting section for more information.

**Flashing White Lights:** The vacuum is operating in an environment that is either too hot or too cold. This vacuum will only function properly in temperatures ranging from 32°F (0°C) to 104°F (40°C). Turn the vacuum off and adjust the room temperature.

**NOTE:** For deep cleaning per ASTM F608 (embedded dirt in carpets), please set to **Carpet/Low Pile** mode.  
**NOTE:** For maximum suction for above-floor cleaning per ASTM F558, set to **Hard Floor** mode.

### CLEANING MODES

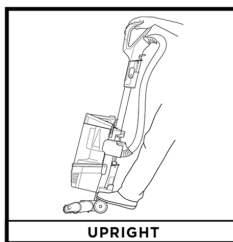

UPRIGHT

To engage brushrolls, step on floor nozzle and tilt handle back.

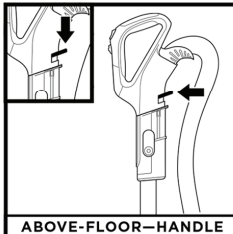

ABOVE-FLOOR—HANDLE

Press the **Handle Release** button to detach the handle from the wand.

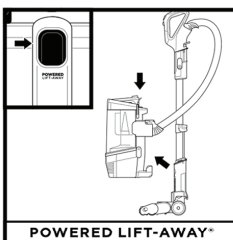

POWERED LIFT-AWAY\*

Press the **Lift-Away** button to detach the pod from the floor nozzle.

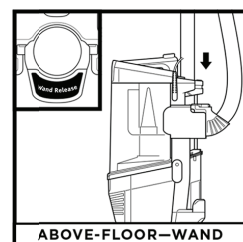

ABOVE-FLOOR—WAND

Press the **Wand Release** button to detach the wand from the pod.

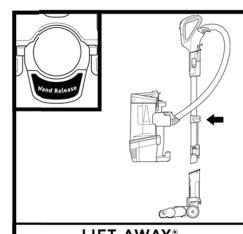

LIFT-AWAY\*

With pod removed, press the **Wand Release** button to detach the wand from the floor nozzle.

**NOTE:** All accessories are compatible with both the wand and the handle.

## EMPTYING THE DUST CUP

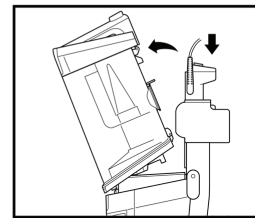

To remove **Dust Cup**, press release button on top of the pod. Tilt dust cup away from wand, then lift to remove.

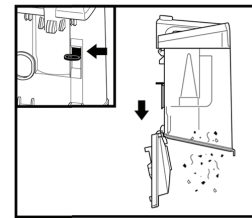

To empty debris into the trash, push the lever on the back of the dust cup and the lid will drop open. To close the lid, pull the lever back until it clicks into place.

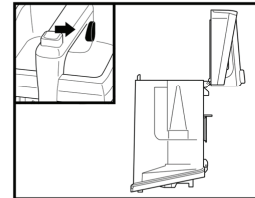

To remove collected debris from **Lint Screen**, press **Handle Release** button and lift handle to access screen.

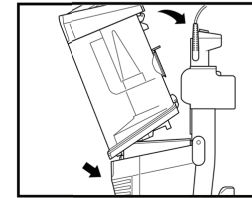

To reinstall, place bottom of dust cup into pod and then tilt until it clicks into place.



**IMPORTANT:** Unplug the power cord before performing any maintenance.

## CLEANING AND REPLACING THE FILTERS

### CLEANING FILTERS

**Regularly rinse and replace the filters to maintain your vacuum's suction power and to maximize the effectiveness of the odor neutralizer technology.**

To prevent damage from cleaning chemicals, rinse filters with cold water only. Allow all filters to air-dry for at least 24 hours before reinstalling them to prevent liquid from being drawn into electric parts.

**IMPORTANT: DO NOT** use soap when cleaning the filters.

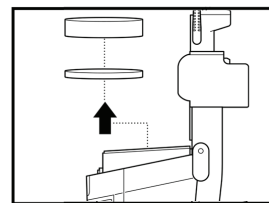

CLEAN PRE-MOTOR FILTERS EVERY MONTH

Remove **Dust Cup**, then lift out the **Foam and Felt Filters**.

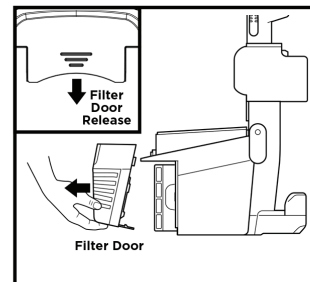

CLEAN HEPA FILTER EVERY YEAR

With the dust cup removed, pull the tab on the bottom of the pod to release the **Filter Door**. Lift off the door, then remove the **HEPA Filter**.

To reinstall, insert **HEPA Filter** into unit and replace filter door.

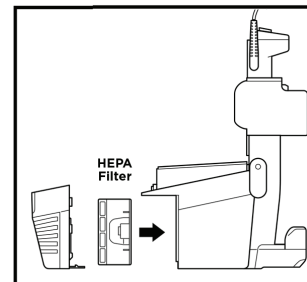

HEPA Filter

**NOTES:**

- The pre-motor filters should be replaced every 2.5 years. The HEPA filter should be replaced every 3 years.
- Vacuum seal is effective against inanimate allergens such as dust and dirt particles.

## MAINTENANCE

### NOZZLE MAINTENANCE

#### SELF-CLEANING BRUSHROLL

If any hair is wrapped around the brushroll, continue vacuuming, using Carpet/Low Pile mode on a bare floor surface, a low-pile carpet, or a small area rug. This will allow the self-cleaning brushroll to remove the hair wrap and send it to the dust cup.

If you run over a hard or sharp object or notice a noise change while vacuuming, check for blockages or objects caught in the brushroll.

If some fibers remain wrapped around the brushroll after continued use, clear them from the brushroll.

## CLEANING THE SOFT ROLLER

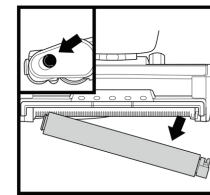

Slide the Soft Roller access button forward to release the Soft Roller.

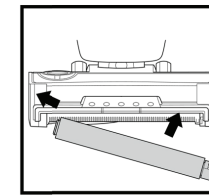

Hand wash the Soft Roller as needed. Use only water, and allow it to air-dry completely for at least 24 hours. Reinsert the Soft Roller in the front of the nozzle until it clicks into place.

## CORD MAINTENANCE

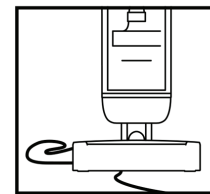

- DO NOT** pull or carry vacuum cleaner by the cord or use cord as a handle.
- DO NOT** unplug by pulling on the cord. Grasp the plug, not the cord.
- DO NOT** close the door on the cord.
- DO NOT** pull the cord around sharp corners.
- DO NOT** leave the cord near heated surfaces.

To minimize the risk of power cord damage, **DO NOT** run the vacuum over the power cord. If this occurs, immediately shut off power to the vacuum and remove the cord from the brushroll or nozzle.

## TROUBLESHOOTING

#### Power cord caught in brushroll or floor nozzle.

- To minimize the risk of power cord damage, **DO NOT** run the vacuum over the power cord. If this occurs, immediately shut off power to the vacuum and remove the cord from the brushroll or nozzle.

- Inspect power cord and plug for any damage before use. **DO NOT** use vacuum cleaner with a damaged cord or plug. Turn off all controls before plugging in or unplugging the vacuum cleaner. Store your vacuum cleaner with the power cord secured around the two cord hooks.

#### Vacuum is not picking up debris. No suction or light suction.

- Check filters to see if they need cleaning. Follow instructions for rinsing and air-drying the filters before reinstalling them.
- Dust cup may be full; empty dust cup.
- Check hose, hose connections, nozzle, wand, pod, and accessories for blockages. Clear any blockages found. See Checking for Blockages section for more information.
- If any hair, string, or carpet fibers are wrapped around the brushroll, extend cleaning time to allow the self-cleaning brushroll to remove them. If some hair or fibers remain wrapped around brushroll after continued use, carefully remove them. See Cleaning the Brushroll section for more information.

#### Vacuum lifts area rugs.

- Make sure Surface Selector switch is set to the Thick Carpet/Area Rug setting.
- Suction is powerful. Take care when vacuuming area rugs or rugs with delicately sewn edges.

#### Brushrolls do not spin.

- If the Headlight Indicator Lights turn red, immediately turn off and unplug the vacuum. Remove pod and wand from floor nozzle and clear any blockages. Reconnect nozzle, plug in vacuum, and turn on power.
- With the power on, recline the handle, which will automatically turn on the brushrolls.

#### Vacuum turns off on its own or headlight indicator light flashes red.

If your vacuum overheats, the thermostat will automatically turn off the motor. Perform the following steps to restart:

- Turn vacuum off and unplug it.
- Empty dust cup and clean filters. See Emptying the Dust Cup and Cleaning and Replacing the Filters sections for more information.
- Check for blockages in hose, wand, floor nozzle, accessories, and inlet openings.
- Allow unit to cool for a minimum of 60 minutes.
- Plug in vacuum and turn it on.

#### Vacuum is emitting air that smells bad.

- Dust cup may be full; empty dust cup. Empty dust cup after each use for optimal odor neutralizer technology performance.
- Check filters to see if they need cleaning. Follow instructions for rinsing and air-drying the filters before reinstalling them.
- Check to make sure odor cartridge is installed in the dial and the dial is installed in the nozzle.
- Check the odor neutralizer technology dial on the nozzle to see what setting is enabled.
- If odor neutralizer technology dial is at any setting from Low to High and the cartridge has been installed for 6 months or longer, consider replacing it.
- If the odor cartridge is still emitting a scent but you dislike it, consider turning the intensity down, or reinstall the dial in the nozzle without the cartridge.
- If the odor neutralizer technology cartridge is not emitting a scent, consider replacing it.

## CHECKING FOR BLOCKAGES

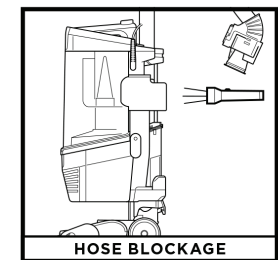

HOSE BLOCKAGE

Detach hose from vacuum pod, and check hose and opening on back of pod for blockages.

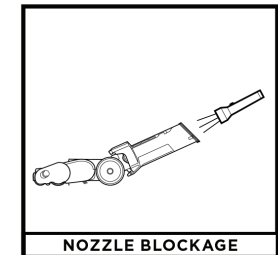

NOZZLE BLOCKAGE

Detach wand from floor nozzle, tilt nozzle neck back, and check opening for blockages.

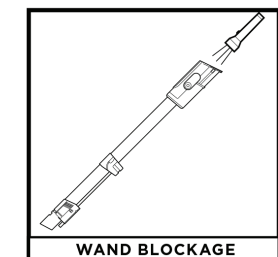

WAND BLOCKAGE

Detach wand from floor nozzle and handle, and check both ends for blockages.

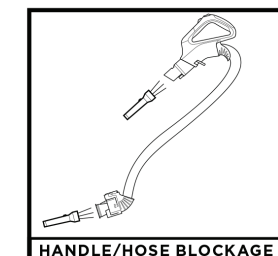

HANDLE/HOSE BLOCKAGE

Detach handle from wand and hose from the vacuum pod, and check openings for blockages.

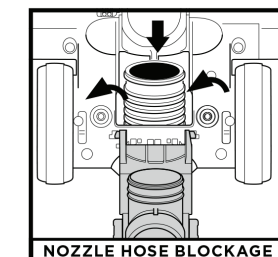

NOZZLE HOSE BLOCKAGE

To access the nozzle hose, pinch the release touchpoints on the bottom of the nozzle, then lift the cover and clear any blockages.

**NOTE:** The images shown here are for illustrative purposes only and may be subject to change.

Please be sure to read the enclosed Shark® Owner's Guide prior to using your unit.

# Shark

**NOTE:** The images shown here are for illustrative purpose only and may vary.

## QUICK START GUIDE

### WHAT'S INSIDE

- Ⓐ Wand
- Ⓑ Vacuum Pod
- Ⓒ Handle & Hose
- Ⓓ Floor Nozzle
- Ⓔ Upholstery Tool
- Ⓕ Crevice Tool
- Ⓖ Odor Neutralizer Technology Dial (no shows)

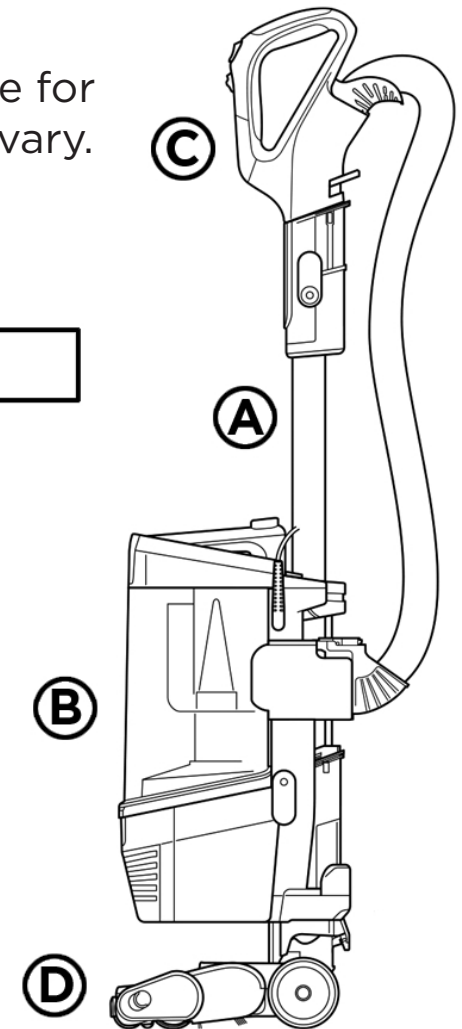
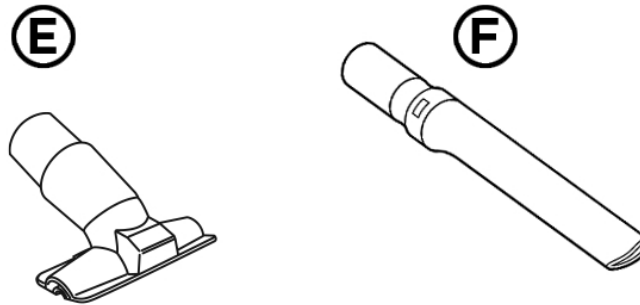

Elbrd: M. C.

OBPN: N/A

8 0 4 0 0 6 9 1 9

SC: 10-01-2022\_25P

PRINTED IN MEXICO

SHNMDL: AZ3000\_B