

IMPORTANT SAFETY INSTRUCTIONS FOR HOUSEHOLD USE ONLY

⚠ WARNING

To reduce the risk of fire, electric shock, injury, or property damage, when using an electrical appliance, basic precautions should always be followed, including the following:

READ ALL INSTRUCTIONS BEFORE USING THIS VACUUM

- Inspect power cord and plug for any damage before use. **DO NOT** use vacuum cleaner with a damaged cord or plug. Turn off all controls before plugging in or unplugging the vacuum cleaner. Store your vacuum cleaner with the power cord secured around the two cord hooks. To minimize the risk of power cord damage, do not allow the motorized brush roll to ingest the cord. If this occurs, immediately shut off power to the vacuum and remove the cord.
- This appliance has a polarized plug, if the plug does not fit fully into the outlet, reverse the plug (one blade is wider than the other). If it still does not fit, contact a qualified electrician. **DO NOT** force into outlet or try to modify to fit.
- Your vacuum cleaner may consist of a motorized nozzle, wand, hose, and/or vacuum pod. This device contains electrical connections, electrical wiring, and moving parts that potentially present risk to the user.
- Use only identical replacement parts.
- Carefully observe and follow the instructions provided below to avoid improper use of the appliance. **DO NOT** use the vacuum for any purpose other than those described in this manual.
- Before use, carefully inspect all parts for any damage. **DO NOT** use if any parts are damaged.
- The use of an extension cord is **NOT** recommended.
- This vacuum cleaner contains no serviceable parts.
- This appliance can be used by persons with reduced physical, sensory or mental capabilities or lack of experience and knowledge if they have been given supervision or instruction concerning use of the appliance in a safe way and understand the hazards involved. Cleaning and user maintenance shall not be made by children. Keep the appliance and its cord out of reach of children. **DO NOT** allow the appliance to be used by children. **DO NOT** allow to be used as a toy. Close supervision is necessary when used near children.
- Always turn off the vacuum cleaner before connecting or disconnecting any motorized nozzles or other accessories.
- DO NOT** handle plug or vacuum cleaner with wet hands.
- DO NOT** use without filters in place.
- Only use Shark® branded filters and accessories.
- DO NOT** damage the power cord:
 - DO NOT** pull or carry vacuum cleaner by the cord or use the cord as a handle.
 - DO NOT** unplug by pulling on cord. Grasp the plug, not the cord.
 - DO NOT** run the vacuum cleaner over the power cord, close a door on the cord, pull the cord around sharp corners, or leave the cord near heated surfaces.
- DO NOT** put any objects into nozzle or accessory openings. **DO NOT** use with any opening blocked; keep free of dust, lint, hair, and anything that may reduce airflow.
- DO NOT** use if nozzle or accessory airflow is restricted. If the air paths or the motorized floor nozzle become blocked, turn the vacuum cleaner off and unplug from electrical outlet. Remove all obstructions before you plug in and turn on the unit again.
- Keep nozzle and all vacuum openings away from hair, face, fingers, uncovered feet, or loose clothing.
- DO NOT** use if vacuum cleaner is not working as it should, or has been dropped, damaged, left outdoors, or dropped into water.
- Use extra care when cleaning on stairs.
- DO NOT** leave the vacuum cleaner unattended while plugged in.
- When powered on, keep the vacuum cleaner moving over the carpet surface at all times to avoid damaging the carpet fibers.
- DO NOT** place vacuum cleaner on unstable surfaces such as chairs or tables.
- Your Shark® vacuum may not be designed to stand up on its own. When taking a break from cleaning, you may need to lean it against furniture or a wall, or lay it flat on the floor. Using the vacuum for an application where the unit lacks stability may result in personal injury.
- DO NOT** use to pick up:
 - Liquids
 - Large objects
 - Hard or sharp objects (glass, nails, screws, or coins)
 - Large quantities of dust (drywall dust, fireplace ash, or embers). **DO NOT** use as an attachment to power tools for dust collection.
 - Smoking or burning objects (hot coals, cigarette butts, or matches)
 - Flammable or combustible materials (lighter fluid, gasoline, or kerosene)
 - Toxic materials (chlorine bleach, ammonia, or drain cleaner)
- DO NOT** use in the following areas:
 - Poorly lit areas
 - Wet or damp surfaces
 - Outdoor areas
 - Spaces that are enclosed and may contain explosive or toxic fumes or vapors (lighter fluid, gasoline, kerosene, paint, paint thinners, mothproofing substances, or flammable dust).
- Turn off all controls before plugging in or unplugging the vacuum.
- Observe the following when interacting with the odor neutralizing cartridge:
 - DO NOT** attempt to disassemble odor neutralizing cartridge.
 - Avoid direct contact with the fragrance pod in the cartridge.
 - DO NOT** directly inhale from the odor neutralizing cartridge.
 - Keep away from children and pets.
 - Keep away from heat, sparks, and open flame.
 - DO NOT** place in direct sunlight.

FRAGRANCE CARTRIDGE FIRST AID

- Avoid contact with fabrics and finished surfaces.
 - Eye contact: Remove contact lenses if present. Rinse continuously with water for several minutes.
 - Skin contact: Wash hands thoroughly after handling. If irritation or rash develops, seek medical advice/attention.
 - Inhalation: Move person to fresh air if they are experiencing any respiratory symptoms. If symptoms persist, seek medical advice/attention.
 - Ingestion: **DO NOT** induce vomiting. Seek medical advice/attention.
- Unplug from electrical outlet when not in use and before any maintenance or cleaning.
 - Hand wash with water only. Washing with cleaning chemicals could damage the unit.
 - During cleaning or routine maintenance, **DO NOT** cut anything other than hair, fibers, or string wrapped around the brushroll.
 - Allow all filters to air-dry completely before replacing in the vacuum to prevent liquid from being drawn into electric parts.
 - Make sure the dust cup and all filters are in place after routine maintenance.
 - If provided, secure the power cord around the two cord hooks during storage.

SAVE THESE INSTRUCTIONS

ASSEMBLY

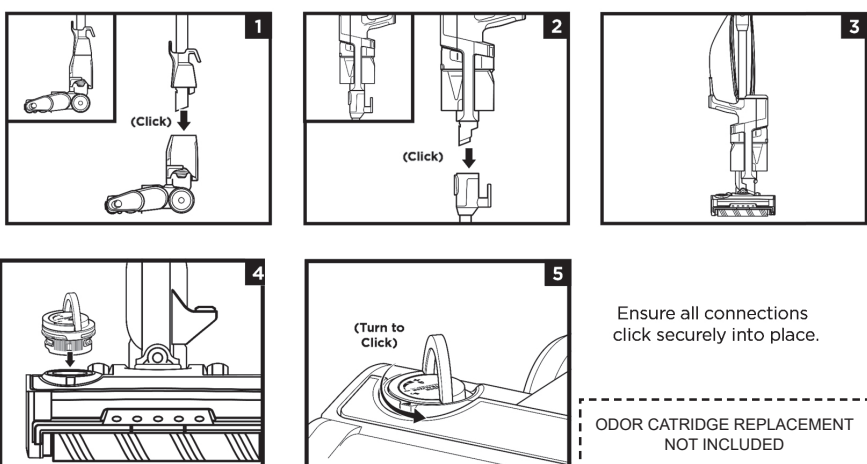

TECHNICAL SPECIFICATIONS

Voltage: 120V-, 60Hz

- Insert **Wand** into **Floor Nozzle**.
- Insert **Handheld Vacuum** into wand.
- For compact storage, hang the handheld vacuum from the **Storage Hook** on the wand.
- Remove **Odor Neutralizer Technology Dial** from bag. Flip up the dial handle, align the teal arrows, then insert the dial into the nozzle.
- To lock and engage the dial, rotate it counterclockwise until it clicks into the desired odor intensity setting.

SETTINGS

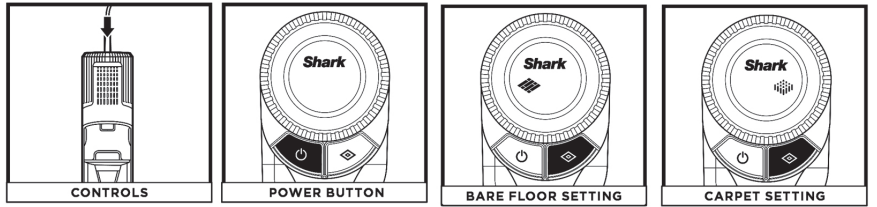

- The control panel is located on the back of the handheld vacuum.
- Power Button** Press the Power button to begin vacuuming. Press again to turn off power. Press the FLOOR TYPE button to toggle between Bare Floor and Carpet settings.
- Bare Floor/Small Area Rugs** When powered on, the vacuum will be in Bare Floor setting. In this setting, the brushrolls spin slowly to clean bare floors and small area rugs.
- Carpet** Press the FLOOR TYPE button to switch to Carpet setting. The brushrolls spin faster to pick up debris below the surface of your carpets.

NOTE: For deep cleaning per ASTM F 608 (embedded dirt in carpets) please use the Carpet setting.
NOTE: Select Carpet for stuck-on dust and debris.

TECHNOLOGY SETTINGS

SETTINGS

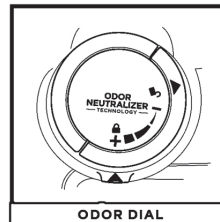

Flip up the dial handle and rotate the odor dial to adjust odor neutralizer technology intensity or to unlock the dial for cartridge access.

Insertion/Removal: Rotate the odor dial to align the teal arrows. Remove the dial to access the odor cartridge for removal or replacement.

Low: Rotate the dial toward the Low position to decrease the intensity to the lowest level when the vacuum is in use.

High: Rotate the dial toward the High position for the highest intensity level when the vacuum is in use. This position is the recommended setting for optimal performance.

ODOR NEUTRALIZER TECHNOLOGY TIPS

Odor Dial Must be Installed for Vacuum to Function Properly

- Remove odor cartridge from dial if you don't want the benefits of the odor neutralization technology.

Maintenance Required

- Clean all filters as recommended under Cleaning Filters.
- Empty the dust cup before storing your vacuum.
- Replace the cartridge as recommended under Odor Cartridge Replacement.
- Visit sharkclean.com/odortech to learn more and purchase replacements.
- If wet pet messes are cleaned up, thoroughly clean the vacuum.

Fragrance Strength Over Time

- The intensity of the odor neutralizer technology's fragrance may diminish over time. It may also have no noticeable fragrance at all. This is natural and does not indicate the technology isn't working. Follow replacement instructions to ensure continued performance.

NOTES: • The odor dial needs to be installed for the vacuum to function properly, with or without the odor cartridge.
• Odor Neutralizer technology effectively deodorizes while interacting with odors from inanimate sources.

ODOR NEUTRALIZER TECHNOLOGY

ODOR CARTRIDGE REPLACEMENT



- Flip up the handle and rotate the dial clockwise until the two teal arrows are aligned. Pull the handle to remove the dial from the nozzle.
- Rotate the cartridge counterclockwise in the dial housing and pull out the cartridge to remove it.
- Align the yellow arrow on the side of the cartridge with the yellow arrow on the side of the dial cover, then insert the cartridge into the dial. Rotate the cartridge clockwise to lock it in place.
- Align the teal arrow on the dial cover with the teal arrow on the nozzle, then reinsert the dial into the nozzle. Rotate the dial counterclockwise until it clicks into an intensity setting to engage. Rotate further to change the intensity setting.
- Dispose of the old cartridge by dropping it into the trash.

The image shown here is for illustrative purposes only and may be subject to change.

CLEANING MODES

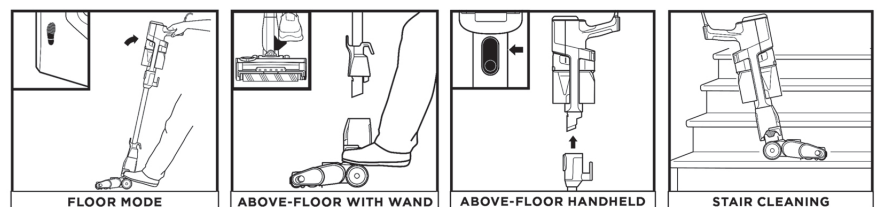

To clean floors, step on floor nozzle and tilt handheld vacuum back.

For more reach, detach the wand. Stand the vacuum upright, step on the **Foot Pedal** on the side of the nozzle, and pull up the wand to detach.

To detach the handheld vacuum, press the **Wand Release** button and lift the handheld vacuum off the wand. Great for cleaning stairs, furniture, and countertops.

To clean stairs or other narrow spaces, attach the handheld vacuum to the floor nozzle.

NOTE: All accessories are compatible with both the wand and the handheld vacuum.



PRINTED IN MEXICO / SC: 04-27-2023 / TAB
OBPN: HZ3000_Series_IB_E_MP_220315
Elbrd: J.E / SHNMDL: HZ3000_B

STORAGE MODE

HANDHELD STORAGE HOOK

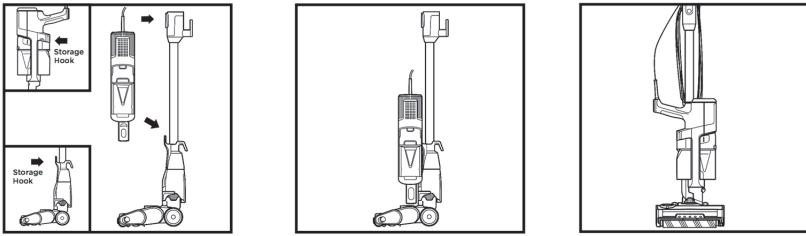

Press the **Wand Release** button near the top of the wand to detach the handheld vacuum. Align the **Catch** on the side of the handheld vacuum with the **Storage Hook** on the wand, then hang the handheld vacuum from the hook.

Wrap the cord around the two cord hooks. Start with the top hook, and leave a little slack in the cord.

MAINTENANCE

IMPORTANT: Unplug the vacuum before performing any maintenance.

EMPTYING THE DUST CUP

Empty the dust cup each time you vacuum and periodically during cleaning, when debris in the dust cup reaches the **MAX** fill line.

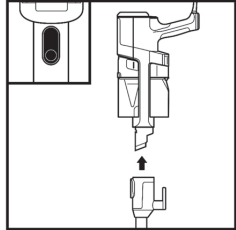

Press the **Wand Release** button and lift off the handheld vacuum.

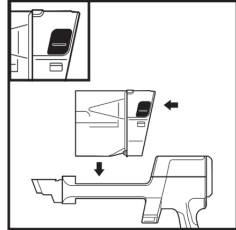

To remove the dust cup from the handheld vacuum, press the two **Dust Cup Release** buttons at the same time and pull out the dust cup from the top.

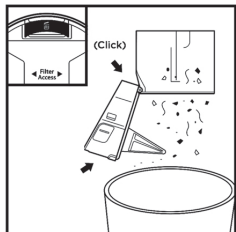

Hold the dust cup over the trash. Press the yellow **Empty** button and pull open the dust cup lid until it clicks and locks in the open position. Gently tap the cone-shaped screen inside the dust cup to knock dust and debris into the trash.

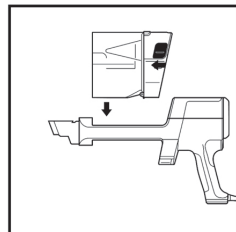

To reinstall, push the lid closed, then insert the dust cup into the handheld vacuum from the top, until it clicks into place.

CLEANING FILTERS

Regularly rinse and replace the filters to maintain your vacuum's suction power and to maximize the effectiveness of odor neutralizer technology.

To prevent damage from cleaning chemicals, rinse filters with cold water only. Do not use soap. Allow all filters to air-dry for at least 24 hours before reinstalling them to prevent liquid from being drawn into electronic parts.

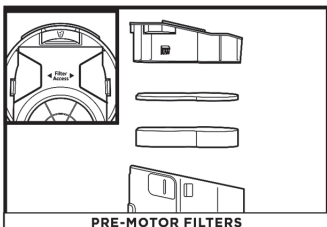

PRE-MOTOR FILTERS

The **Pre-Motor Filters** should be rinsed every month. To remove the pre-motor filters, detach the dust cup, then slide down the Filter Access buttons on both sides of the dust cup lid. Pull out the filter housing, then lift out the **Felt Filter** by the pull tab. Next, remove the **Foam Filter**. After the filters have been rinsed and are completely dry, insert the foam filter into the housing first, then slide in the felt filter, and reinstall the housing into the dust cup lid.

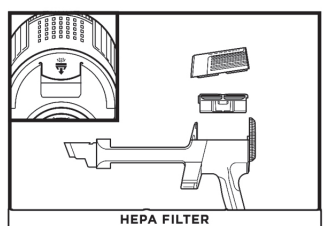

HEPA FILTER

The **HEPA Filter** should be rinsed every 6 months. To remove the HEPA filter, detach the dust cup, then pull the **Filter Release** tab on the handheld vacuum filter cover. Remove the cover, then squeeze the side tabs on the HEPA filter and lift it out. After the filter has been rinsed and is completely dry, reinsert it into the handheld vacuum, then reattach the filter cover.

NOTE: The pre-motor filters should be replaced every 2.5 years. The post-motor filter should be replaced every 3 years.

CHECKING FOR BLOCKAGES

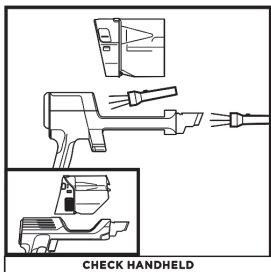

CHECK HANDHELD

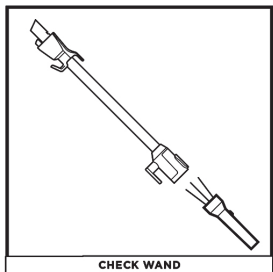

CHECK WAND

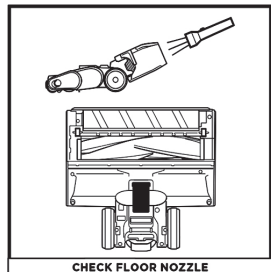

CHECK FLOOR NOZZLE

Remove the handheld vacuum from the wand and check all dust cup intake openings for debris or blockages.

Detach the wand and check it for blockages.

Detach the wand, then tilt the floor nozzle **Debris Intake** back and check openings for blockages.

MAINTENANCE

SELF-CLEANING BRUSHROLL MAINTENANCE

If any hair is wrapped around the brush roll, continue vacuuming, using Carpet mode on a bare floor surface, a low-pile carpet, or a small area rug. This will allow the self-cleaning brushroll to remove the hair wrap and send it to the dust cup.

If you run over a hard or sharp object or notice a noise change while vacuuming, check for blockages or objects caught in the brushroll. If some fibers remain wrapped around the brushroll after continued use, clear them from the brushroll.

“NOTE: Accessories may vary depending on the model.

Refer to quick guide, if available.

The images shown here are for illustrative purposes only and may be subject to change.”

CLEANING THE SOFT ROLLER

1. To remove the Soft Roller, slide the **Eject Roller** button on the floor nozzle.
2. Tap loose debris off the Soft Roller. Use a dry towel to wipe it clean, and to remove any debris caught in the teeth behind the Soft Roller.
3. Hand-wash the Soft Roller as needed. Use only water, and let it air-dry completely for at least 24 hours.
4. Reinsert the Soft Roller and press it in until it clicks securely into place.

CORD MAINTENANCE

1. **DO NOT** pull or carry vacuum cleaner by the cord or use cord as a handle.
2. **DO NOT** unplug by pulling on the cord. Grasp the plug, not the cord.
3. **DO NOT** close the door on the cord.
4. **DO NOT** pull the cord around sharp corners.
5. **DO NOT** leave the cord near heated surfaces.

To minimize the risk of power cord damage, **DO NOT** run the vacuum over the power cord. If this occurs, immediately shut off power to the vacuum and remove the cord from the brushroll or nozzle.

NOTE: For best performance, keep the Soft Roller clean with regular maintenance.

TROUBLESHOOTING

Power cord caught in brushroll or floor nozzle.

- To minimize the risk of power cord damage, **DO NOT** run the vacuum over the power cord. If this occurs, immediately shut off power to the vacuum and remove the cord from the brushroll or nozzle.
- Inspect power cord and plug for any damage before use. **DO NOT** use vacuum cleaner with a damaged cord or plug. Turn off all controls before plugging in or unplugging the vacuum cleaner. Store your vacuum cleaner with the power cord secured around the two cord hooks.

Vacuum is not picking up debris. No suction or light suction.

See Maintenance section for more information.

- Empty the dust cup. Check filters to see if they need cleaning. Follow instructions for rinsing and completely air-drying the filters before reinstalling them.
- Clear any blockages in the nozzle, wand, handheld vacuum, or accessories. Vacuum is not picking up debris. No suction or light suction. See maintenance section for more information.
 - If any string, hair, or carpet fibers remain wrapped around the brushroll after continued use, carefully clear them away.
 - Remove any blockages from the debris intake in the floor nozzle. Pinch the tabs on the bottom of the nozzle to open the cover, and lift up the intake tube. Clear blockages, then push the tube down and press the nozzle cover closed.

Vacuum lifts area rugs.

- Suction is powerful. Take care when vacuuming area rugs or rugs with delicately sewn edges.
- Turn off the unit to disengage the brushroll. To restart, press the power button on the handle.

NOTE: Clean area rugs in Bare Floor mode or with accessories. See Available Accessories section.

Vacuum turns off on its own or the indicator light flashes red.

If your vacuum overheats, the thermostat will automatically turn off the motor. Perform the following steps to restart:

1. Turn off the vacuum and unplug it.
2. Empty the dust cup and clean the filters. See Emptying the Dust Cup and Cleaning Filters sections.
3. Check for blockages in the wand, floor nozzle, handheld vacuum, inlet openings, and accessories.
4. Reassemble the entire vacuum and ensure all parts click into place.
5. Allow unit to cool for a minimum of 60 minutes.
6. Plug in vacuum and turn it on.

Handheld vacuum is warm.

Due to the strong suction power of the vacuum, it is normal for the area around the filter exhaust to become warm during and after use. Turn off the vacuum and wait 10 minutes for it to cool down. If it still feels warm, clean the pre-motor and post-motor filters. See Maintenance section for filter cleaning instructions.

Vacuum is emitting air that smells bad.

- Dust cup may be full; empty dust cup.
- Empty the dust cup after each use for optimal odor neutralization.
- To help prevent bad odors, empty the dust cup after each use.
- Check filters to see if they need cleaning. Follow instructions for rinsing and air-drying the filters before re-installing them.
- Check to make sure odor neutralizer cartridge is installed into the nozzle.
- Check the odor neutralizer dial on the nozzle to see what setting is enabled.
- If in Low to High setting and odor cartridge has been installed for 6 months or longer, consider replacing it.
- If the neutralizer is still emitting a scent but you dislike it, consider turning the intensity down, or reinstall the dial in the nozzle without the cartridge.
- If the neutralizer is not emitting a scent, consider replacing it.

For all other issues. Please contact a service center.

Please be sure to read the enclosed Shark® Owner's Guide prior to using your unit.

QUICK START GUIDE

WHAT'S INSIDE

- (A) Wand
- (B) Floor Nozzle
- (C) Handheld Vacuum
- (D) Odor Neutralizer Technology Dial
- (E) Pet Multi-Tool
- (F) Crevice Tool

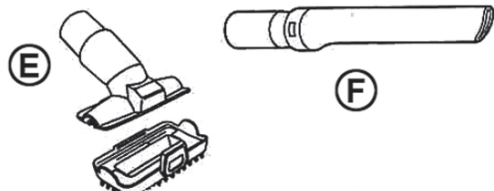

ASSEMBLY

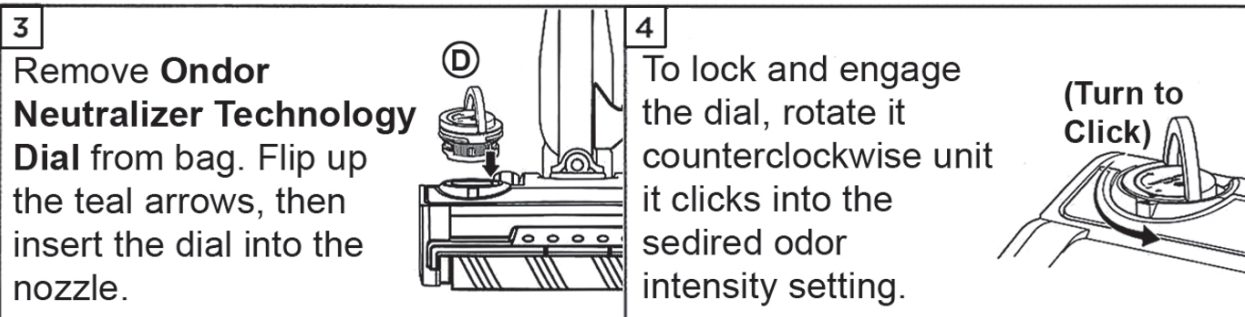
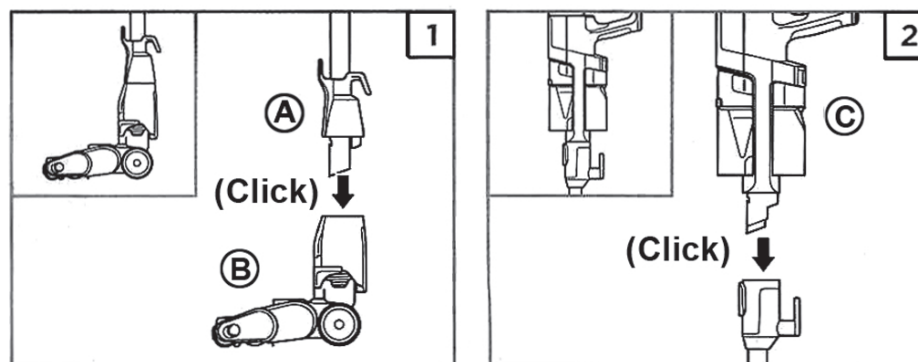

3 Remove **Odor Neutralizer Technology Dial** from bag. Flip up the teal arrows, then insert the dial into the nozzle.

4 To lock and engage the dial, rotate it counterclockwise until it clicks into the selected odor intensity setting.

“NOTE: Accessories may vary depending on the model.

The images shown here are for illustrative purposes only and may be subject to change.”



814000037A



PRINTED IN MEXICO / SC: 04-28-2023 / 0.5P

OBPN: N/A

Elbrd: J.E / SHNMDL: HZ3000_B